



US00D334411S

United States Patent [19]

[11] Patent Number: **Des. 334,411**

Kuroda

[45] Date of Patent: **** Mar. 30, 1993**

[54] **SPRING CLIP**

[75] Inventor: **Akitada Kuroda, Aichi, Japan**

[73] Assignee: **LEC Kabushiki Kaisha, Tokyo, Japan**

[**] Term: **14 Years**

[21] Appl. No.: **738,749**

[22] Filed: **Aug. 1, 1991**

[52] U.S. Cl. **D19/65; D19/86; D8/395**

[58] Field of Search **D8/394, 395; D19/65, D19/86, 90, 91, 99, 100; 24/67 R, 67.1-67.11, 545, 546, 561, 563, 3 J, 3 H, 30.58**

[56] **References Cited**

U.S. PATENT DOCUMENTS

1,610,861	12/1926	Knight	24/67.11
3,348,272	10/1967	Germani	24/563
3,772,741	11/1973	Rosalik	24/563 X
3,898,717	8/1975	Schwartz	24/561
4,110,872	9/1978	Gould	24/67.11
4,991,269	2/1991	Kuroda et al.	24/67.11
5,136,754	8/1992	Kuroda	24/67.9

Primary Examiner—Nelson C. Holtje
Assistant Examiner—Martha Thompson
Attorney, Agent, or Firm—Keck, Mahin & Cate

[57] **CLAIM**

The ornamental design for a spring clip, as shown and described.

DESCRIPTION

FIG. 1 is a top plan view of a spring clip showing my new design;
FIG. 2 is a front elevational view;
FIG. 3 is a bottom plan view;
FIG. 4 is a rear elevational view;
FIG. 5 is a right side elevational view, the left side being a mirror image thereof;
FIG. 6 is a cross-sectional view taken in the direction of arrows 6—6 in FIG. 2;
FIG. 7 is a top perspective view;
FIG. 8 is a top perspective view in an unclamped condition; and,
FIG. 9 is a top perspective view thereof, the fragmentary sheets of paper being depicted by means of broken lines for illustrative purposes only and forming no part of the claimed design.

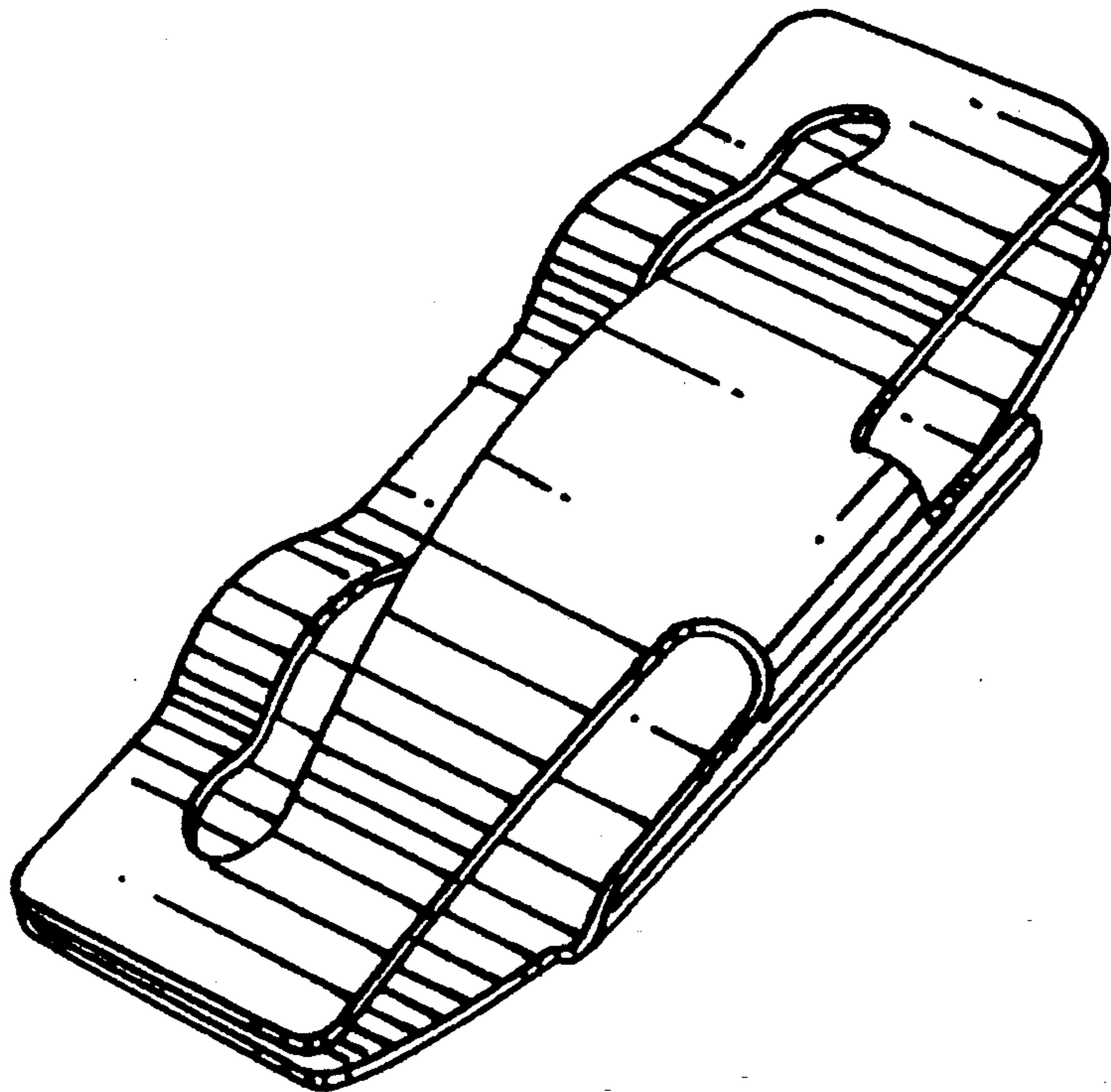

FIG. 1

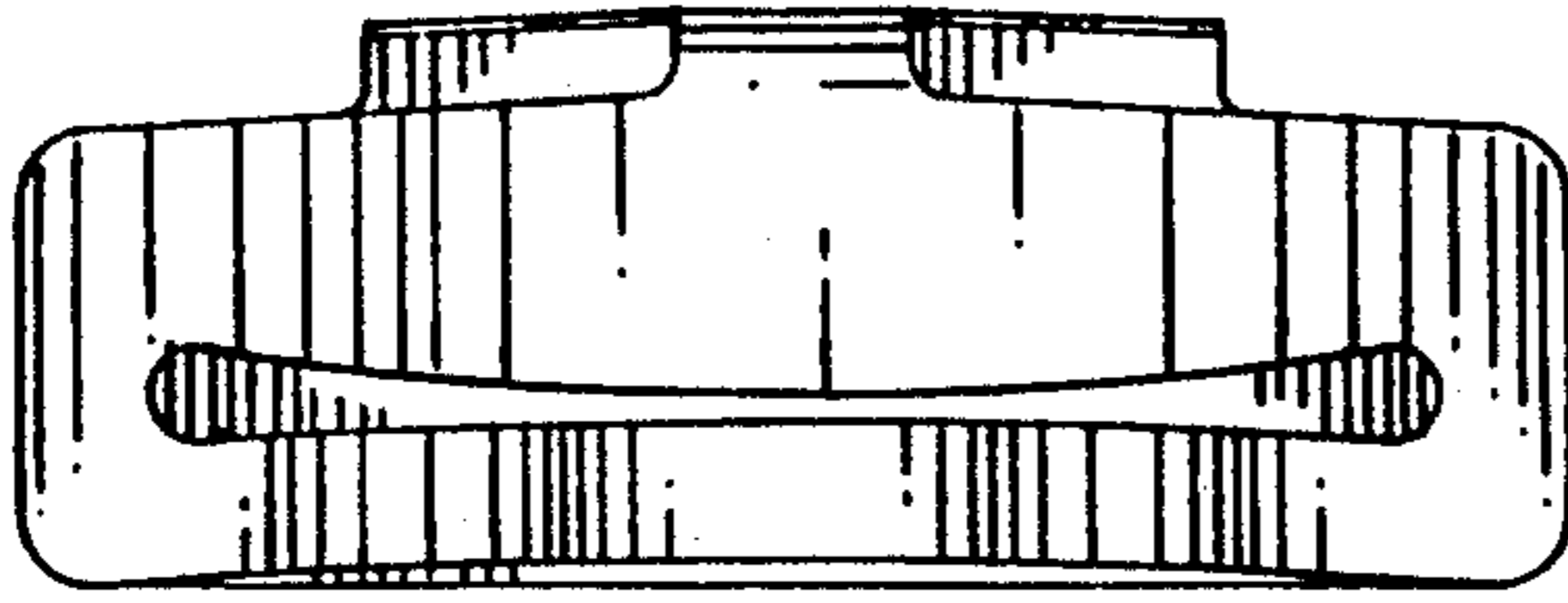

FIG. 2

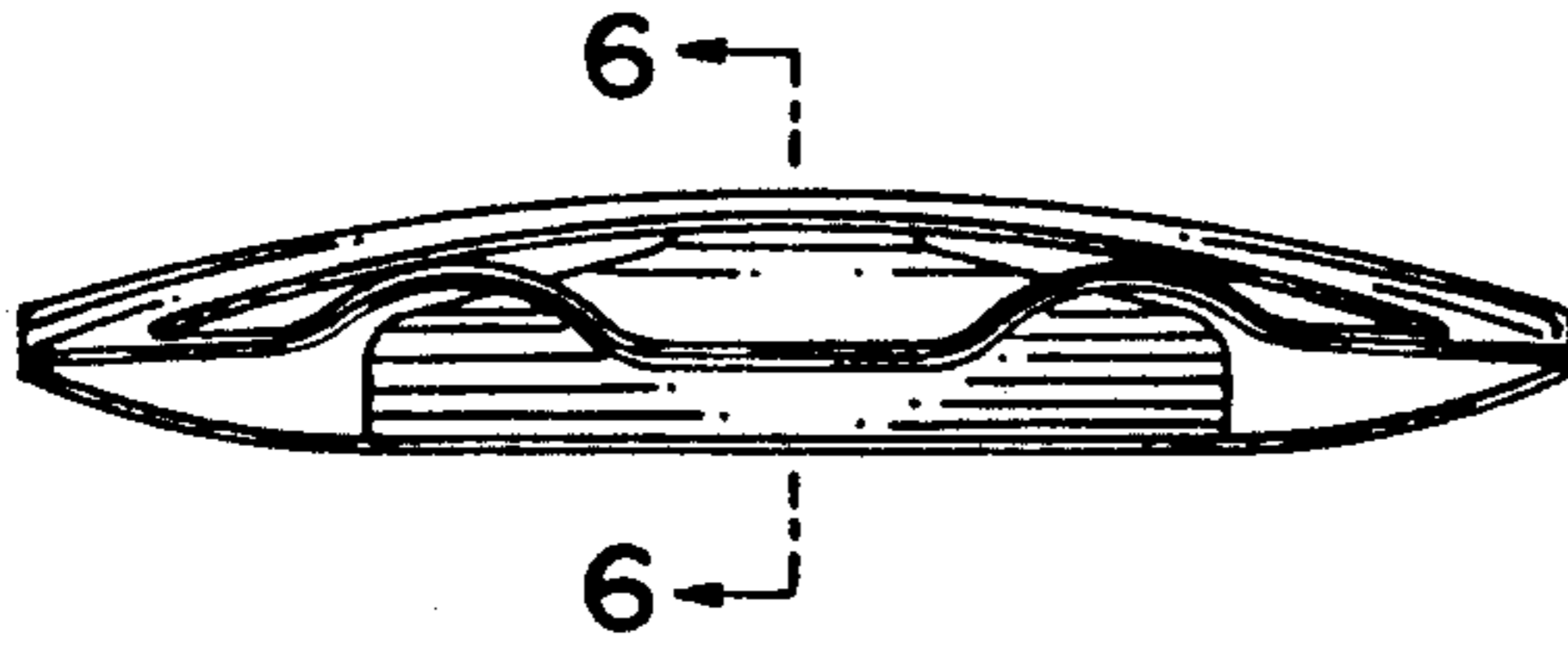

FIG. 3

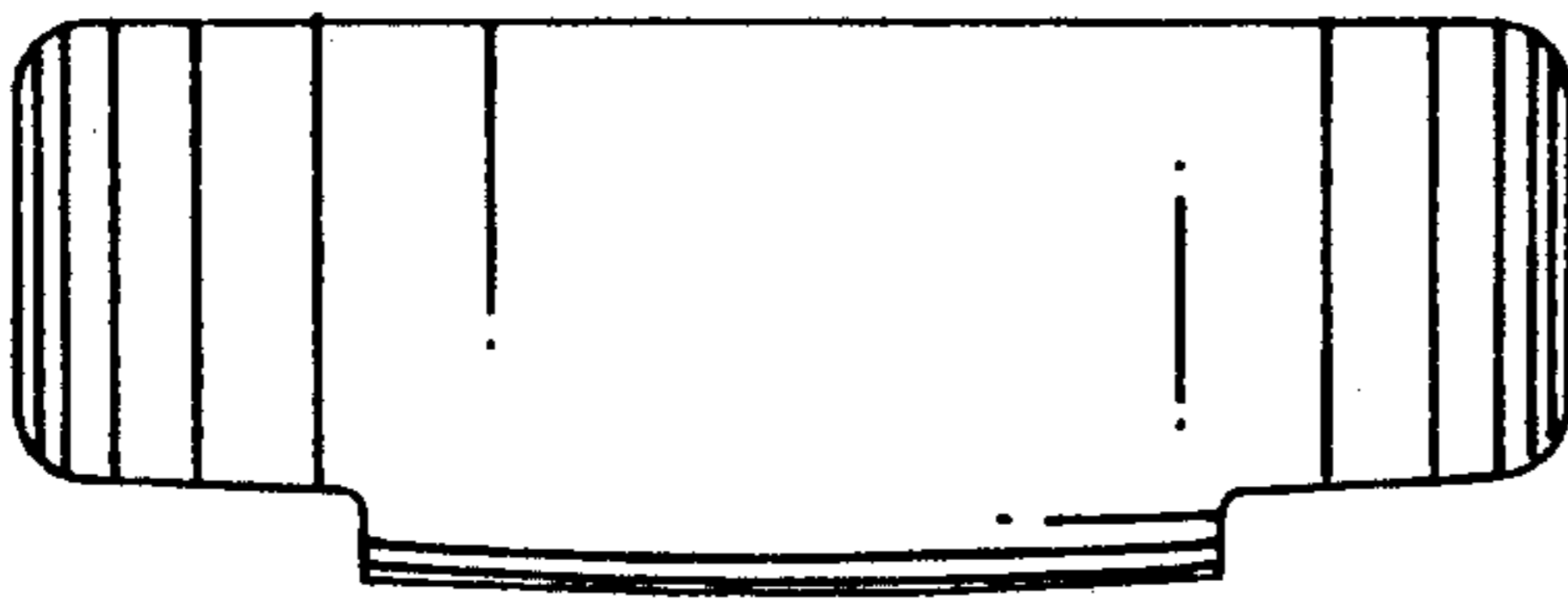

FIG. 4

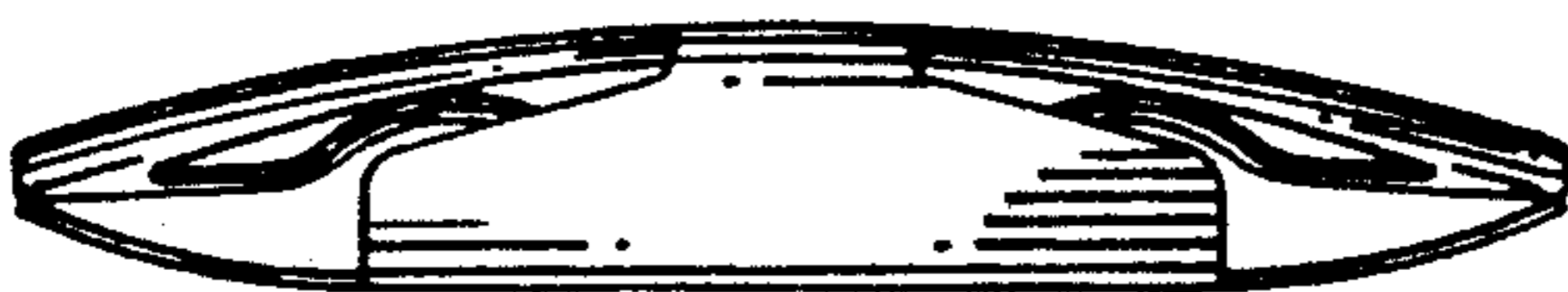

FIG. 5

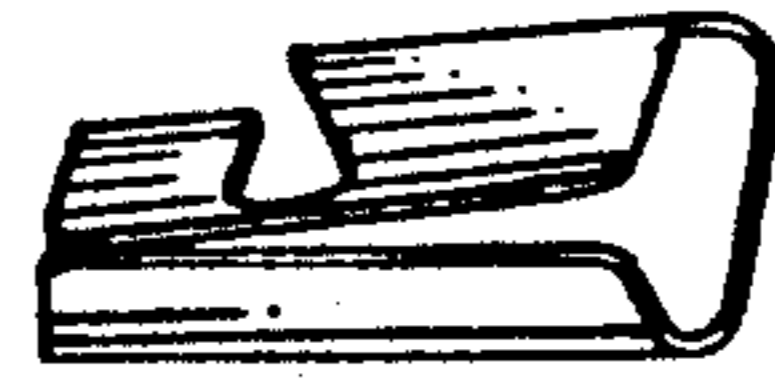

FIG. 6



FIG. 7

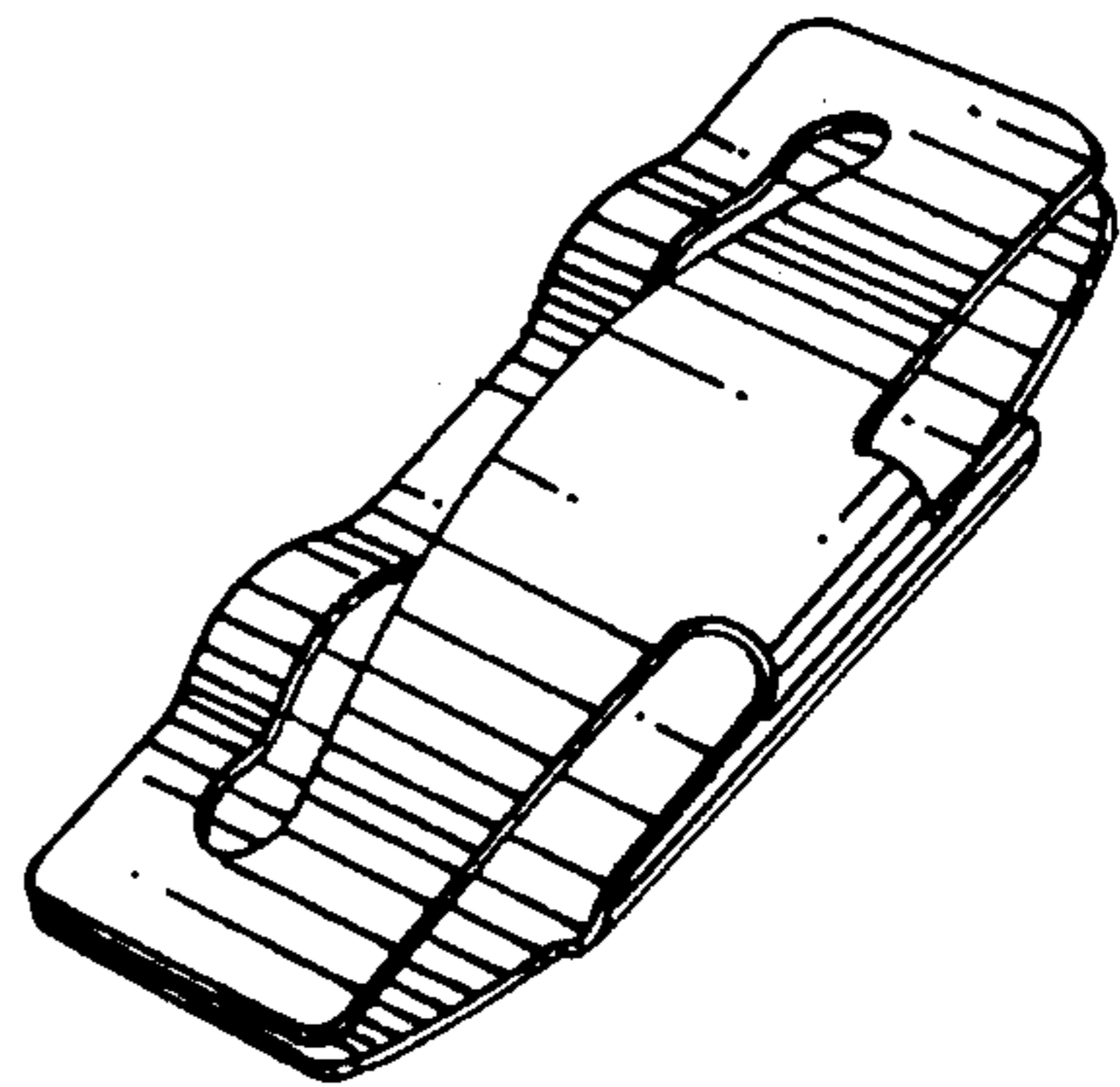

FIG. 8

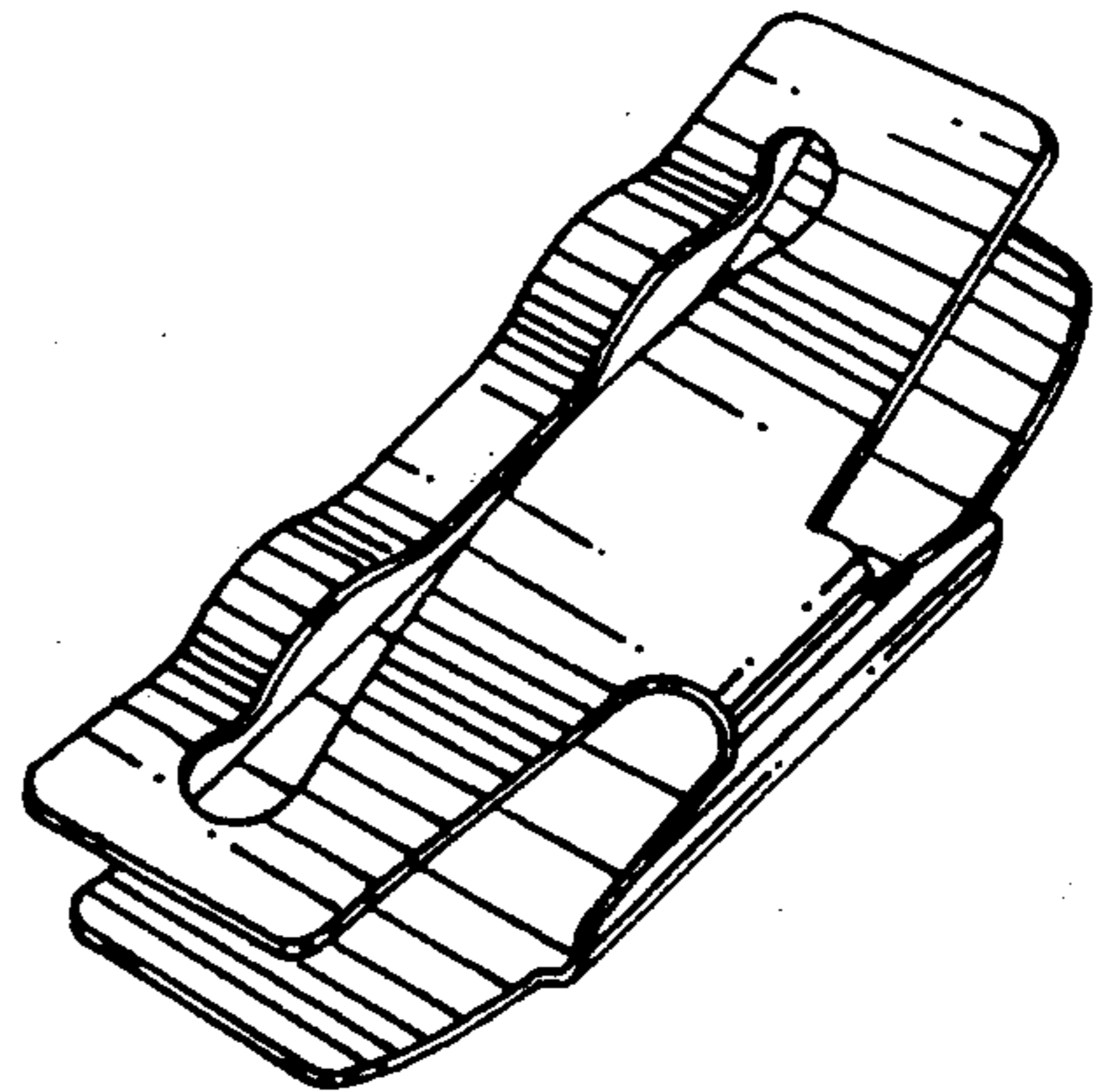

FIG. 9

