



US00D334284S

United States Patent [19]

[11] Patent Number: Des. 334,284

Horikiri

[45] Date of Patent: ** Mar. 30, 1993

[54] CASE FOR AUDIO TAPE CASSETTES

[75] Inventor: Kazuhisa Horikiri, Kanagawa, Japan

[73] Assignee: Fuji Photo Film Co., Ltd., Kanagawa, Japan

[**] Term: 14 Years

[21] Appl. No.: 716,231

[22] Filed: Jun. 17, 1991

[52] U.S. Cl. D3/35

[58] Field of Search D3/30.1, 35, 39, 56, D3/59, 60, 71, 74, 79, 100; 206/312, 387, 444-470; 360/133

[56] References Cited

U.S. PATENT DOCUMENTS

D. 271,064	10/1983	Shiradio	D3/35
3,272,325	9/1966	Schoemmakers	D3/35
3,638,788	2/1972	Solomon	D3/35
3,978,985	9/1976	Zinnbauer	206/387
4,863,025	9/1989	Wolf	206/387
5,038,932	8/1991	Shen	D3/35
5,064,065	11/1991	Takahashi	206/387

Primary Examiner—A. Hugo Word
Assistant Examiner—Celia Murphy

Attorney, Agent, or Firm—Young & Thompson

[57] CLAIM

The ornamental design for a case for audio tape cassettes, as shown and described.

DESCRIPTION

FIG. 1 is a perspective view of a first embodiment of a case for audio tape cassettes, showing my new design; FIG. 2 is a front elevational view thereof; FIG. 3 is a rear elevational view thereof; FIG. 4 is a top plan view thereof; FIG. 5 is a bottom plan view thereof; FIG. 6 is a left side elevational view thereof; FIG. 7 is a right side elevational view thereof; FIG. 8 is a perspective view thereof, being shown in an open position; FIG. 9 is a perspective view of an alternate embodiment of the design shown in FIG. 1; FIG. 10 is a front elevational view of FIG. 9; FIG. 11 is a rear elevational view of FIG. 9; FIG. 12 is a top plan view of FIG. 9; FIG. 13 is a bottom plan view of FIG. 9; FIG. 14 is a left side elevational view of FIG. 9; FIG. 15 is a right side elevational view of FIG. 9; and, FIG. 16 is a perspective view of FIG. 9 being shown in an open position.

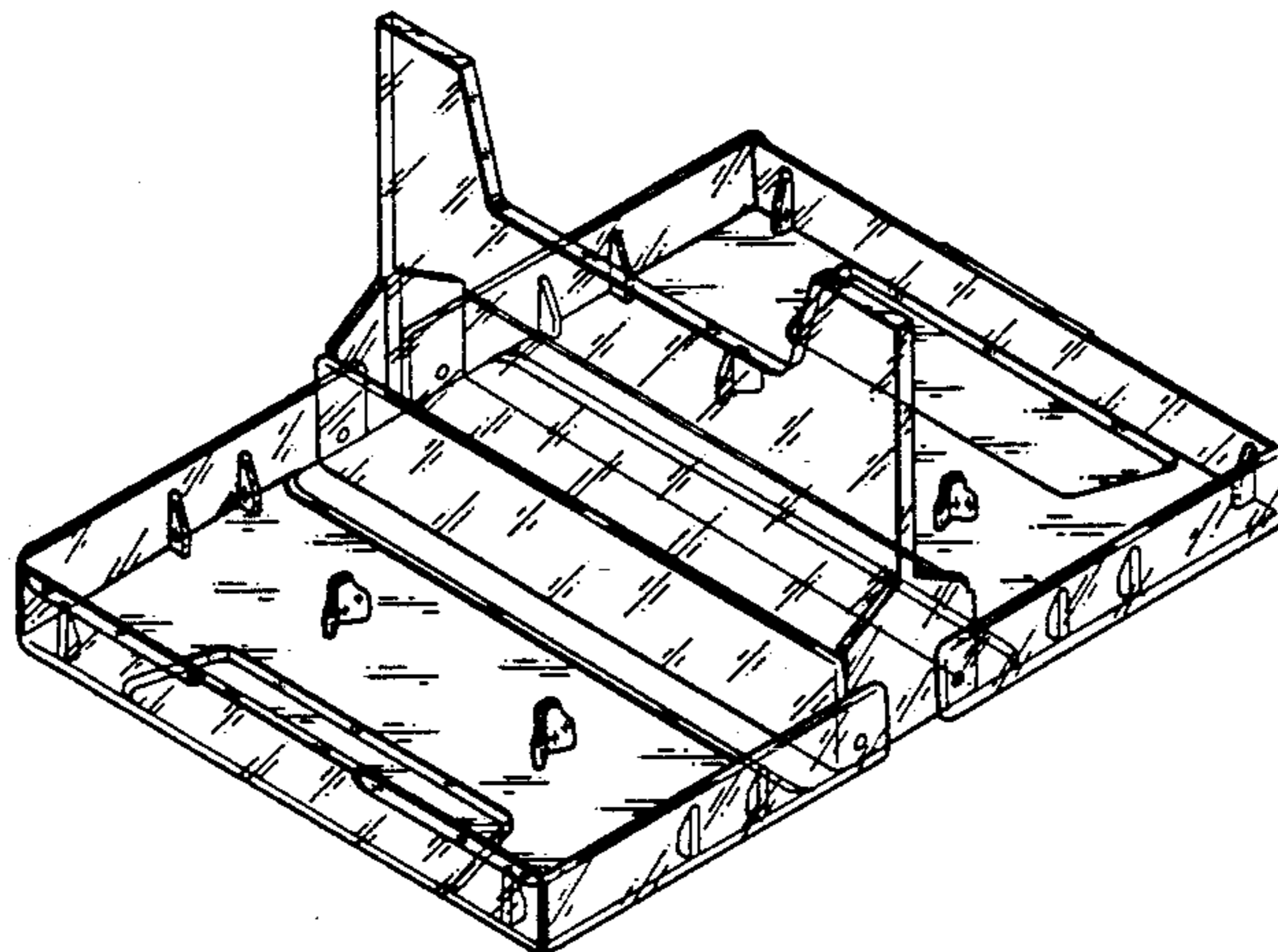
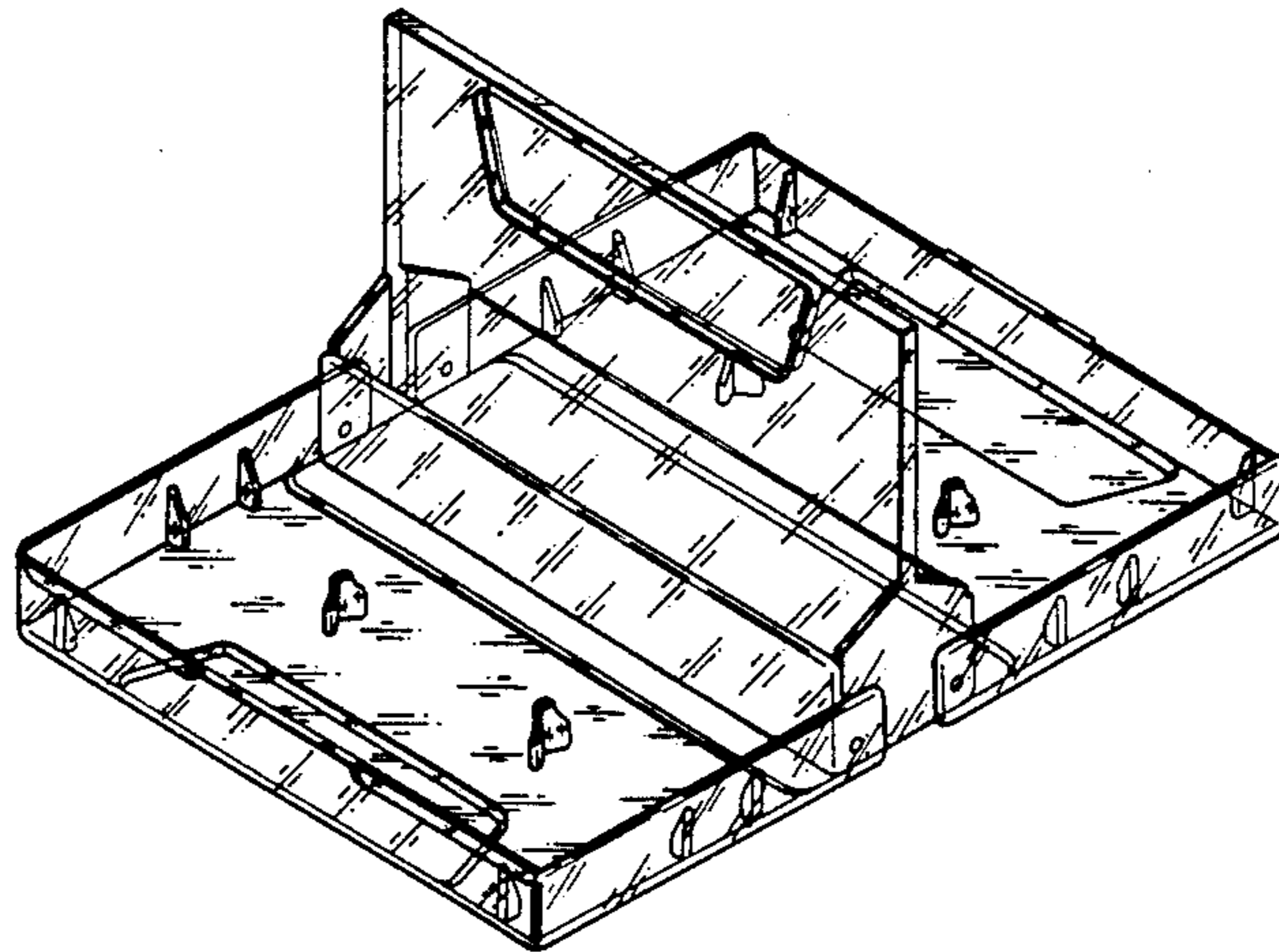

FIG. 1

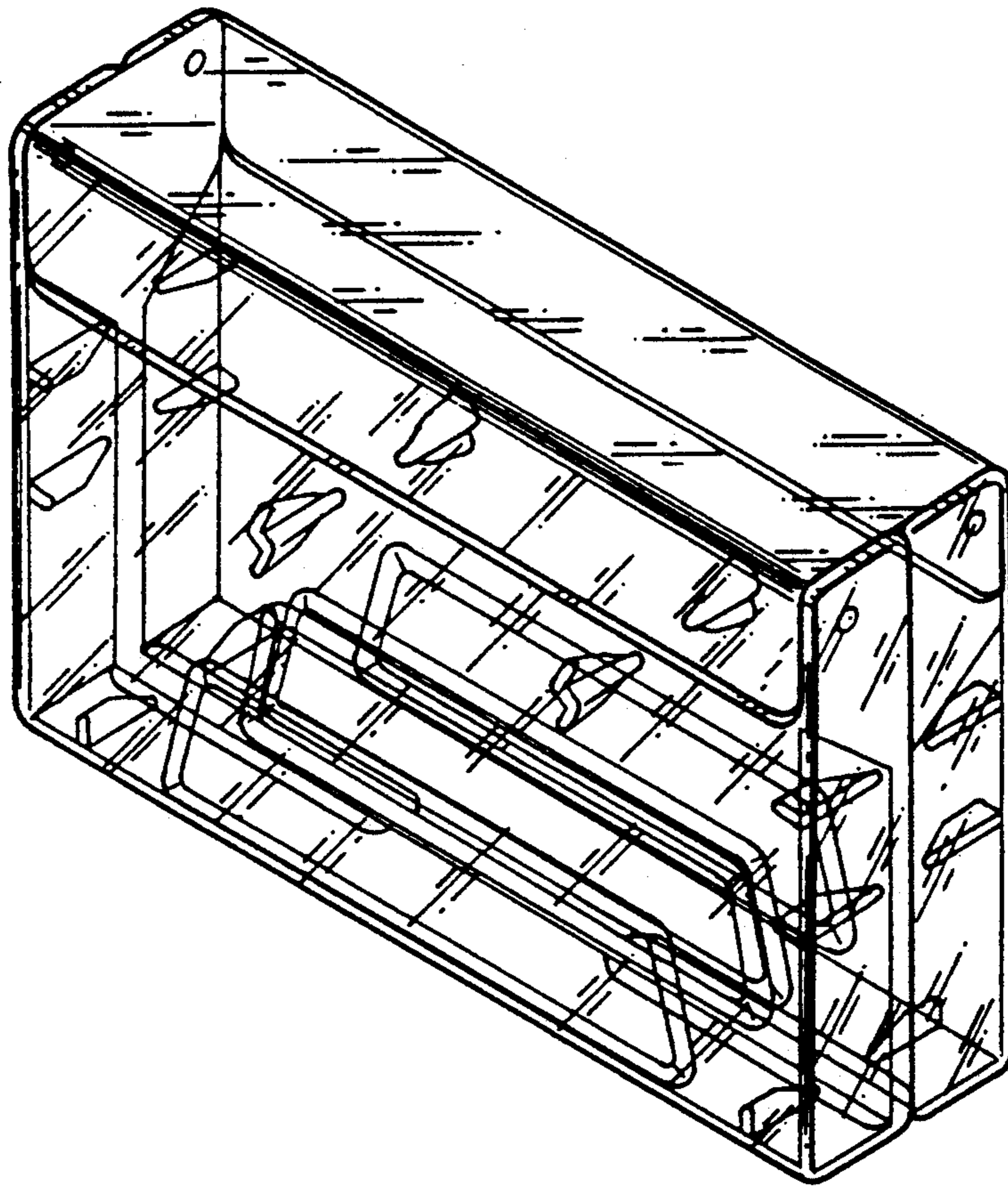

FIG. 2

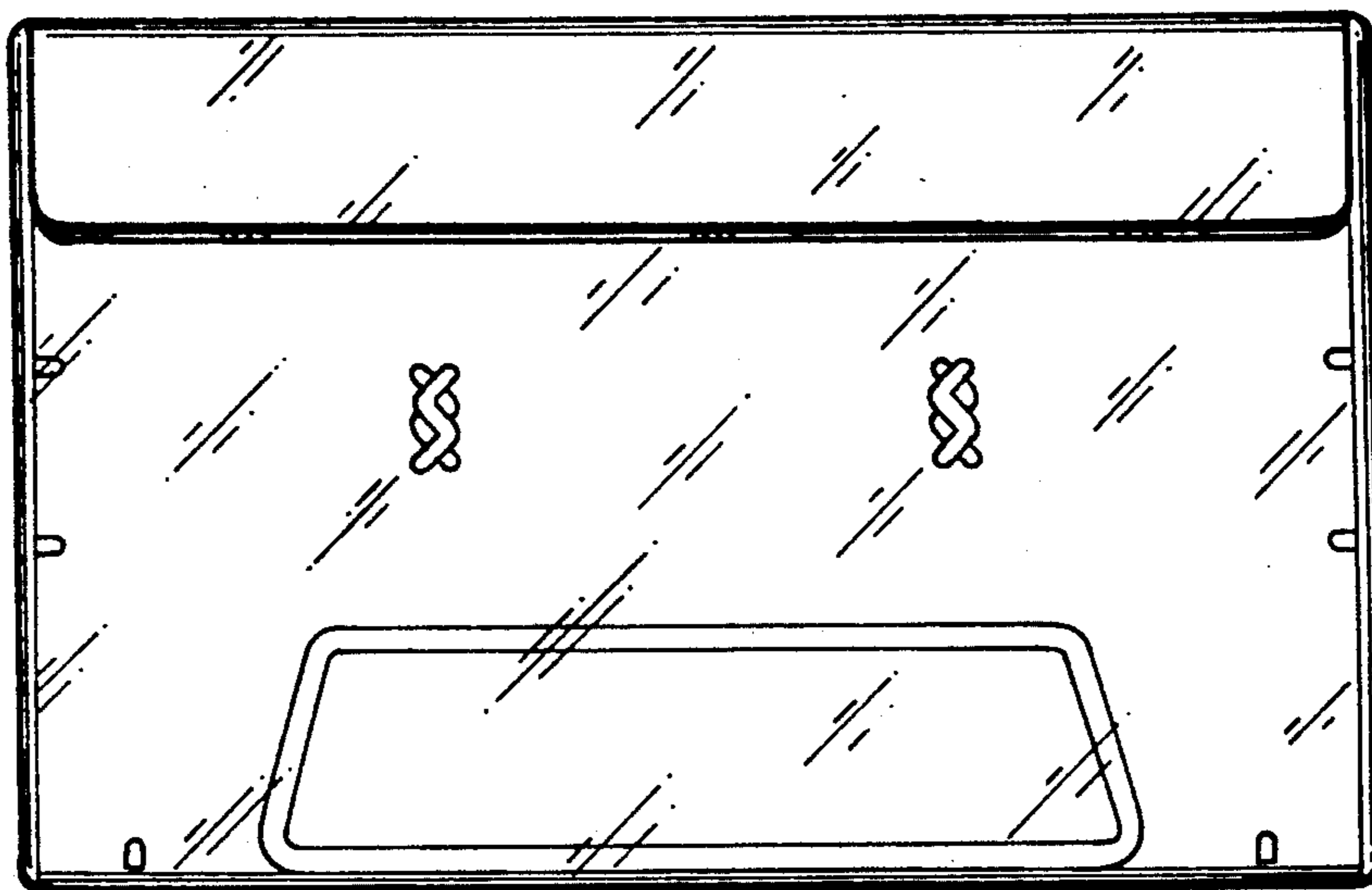

FIG. 3

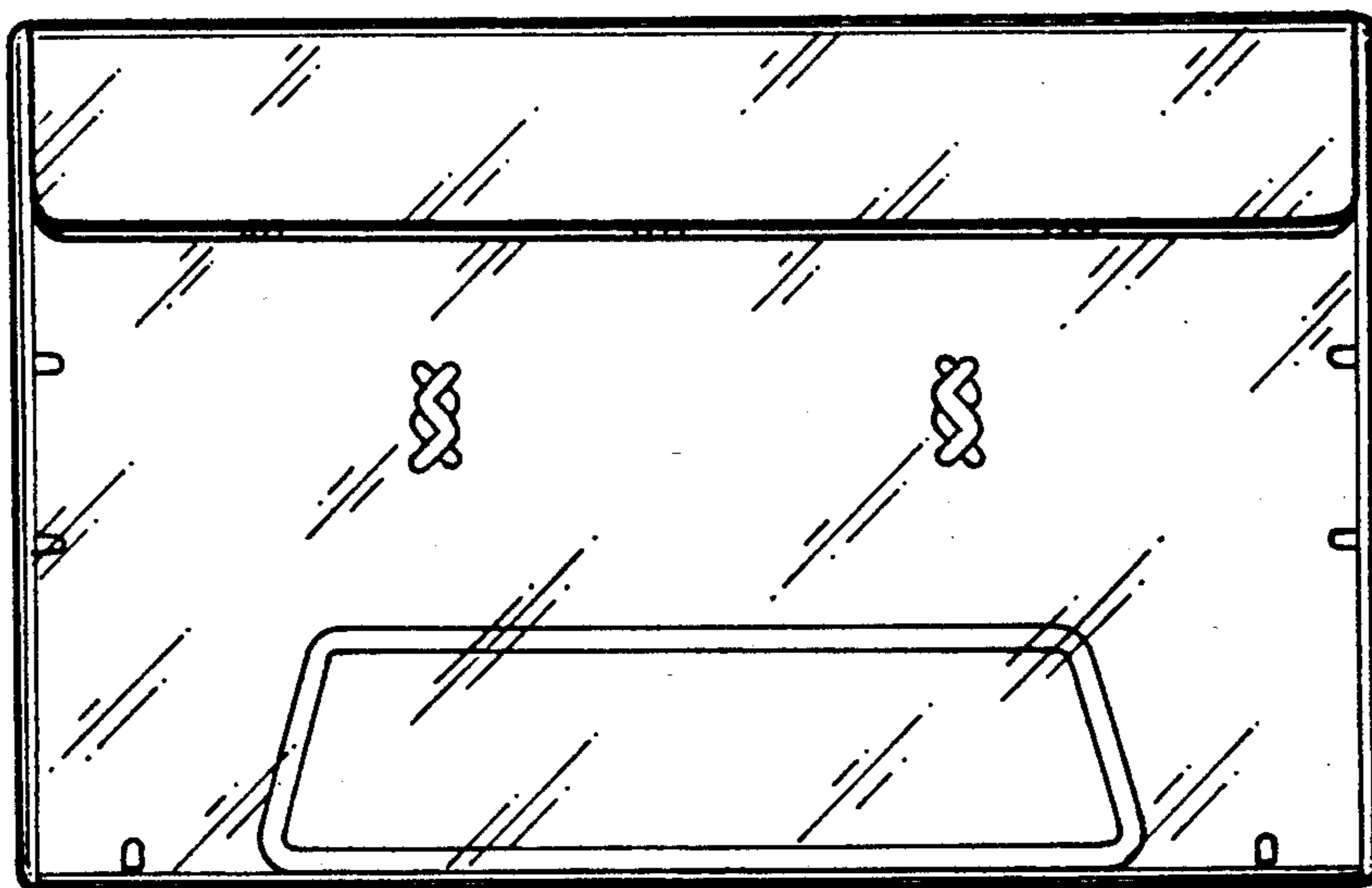

FIG. 4

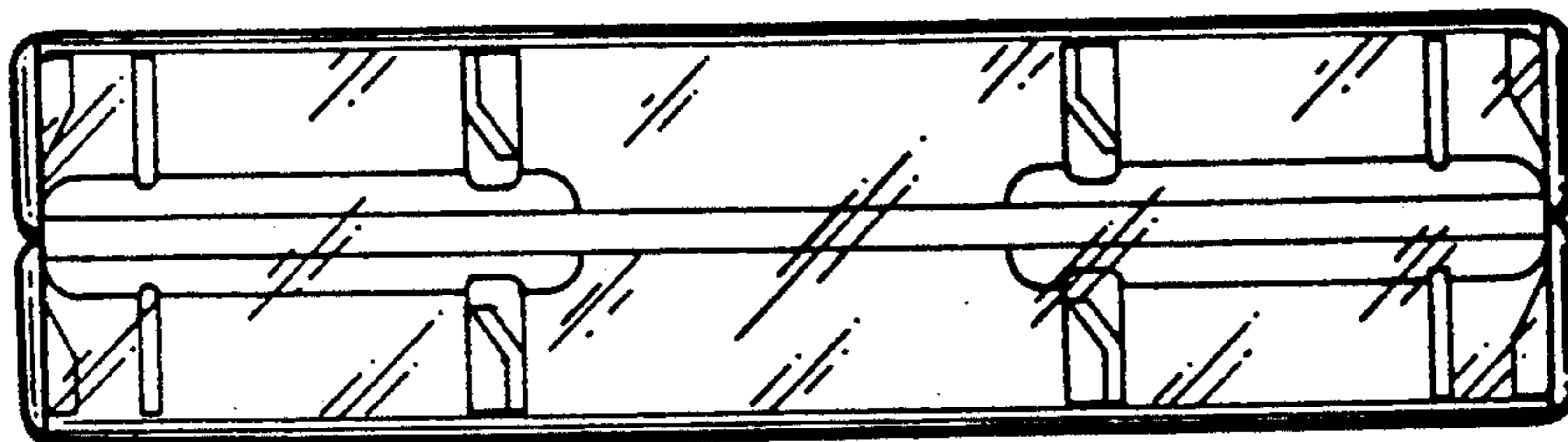

FIG. 5

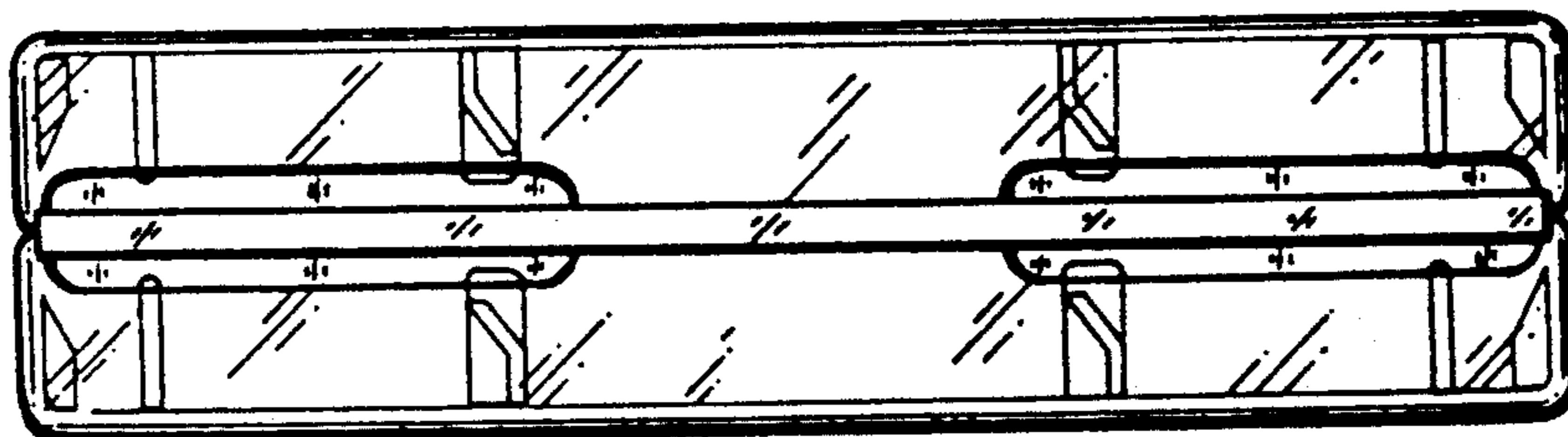

FIG. 6

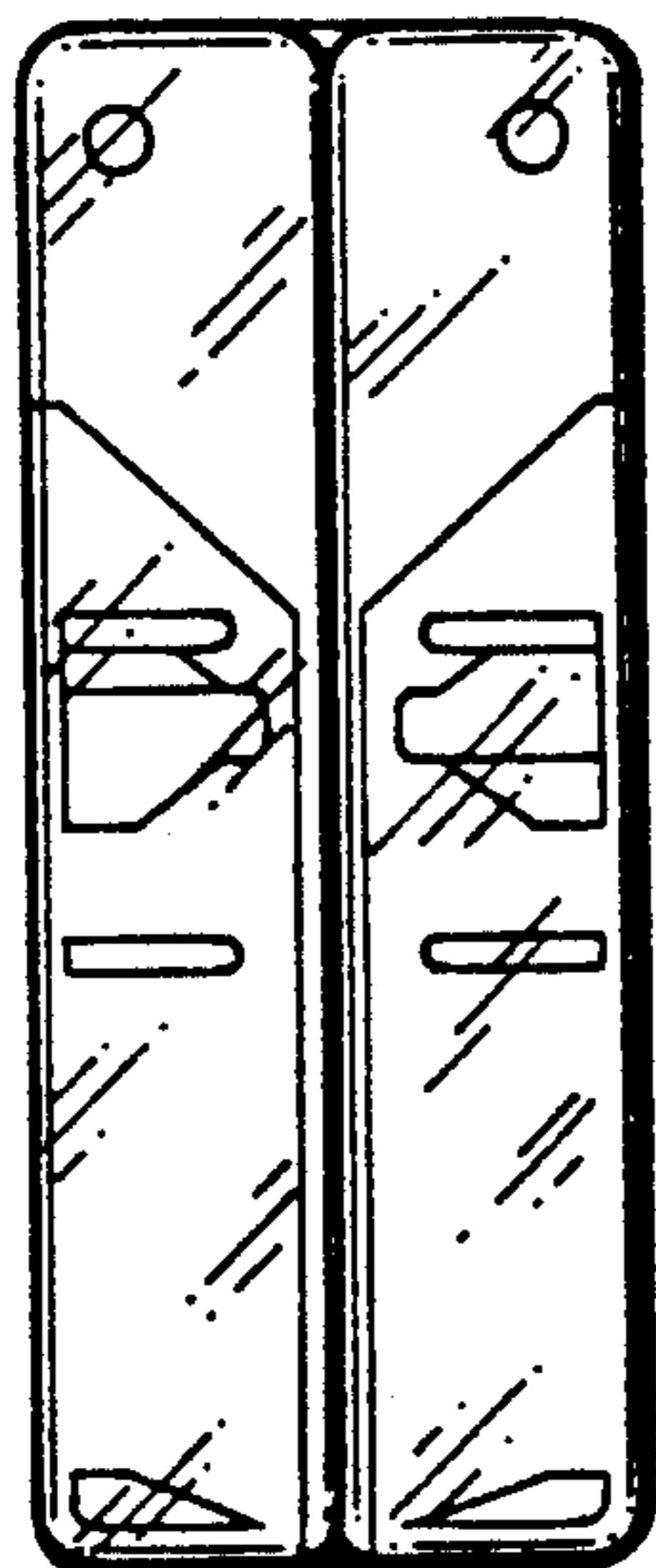

FIG. 7

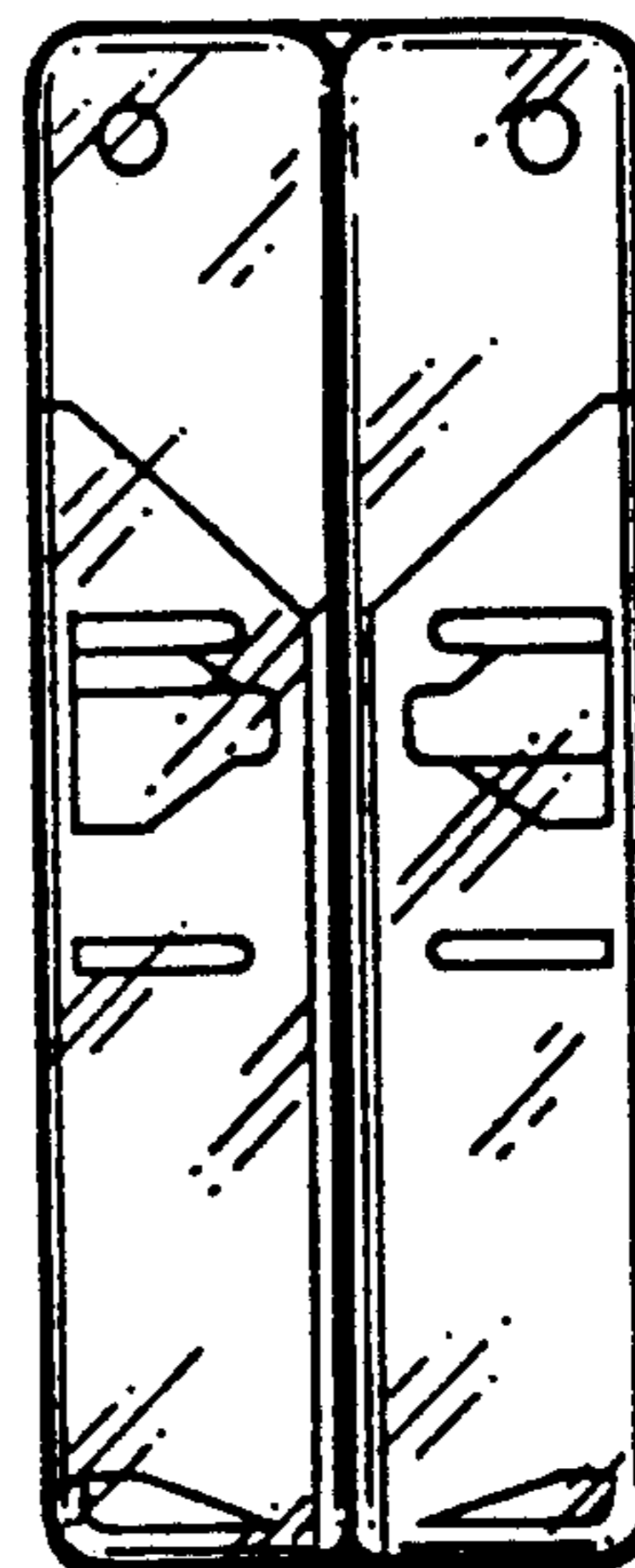

FIG. 8

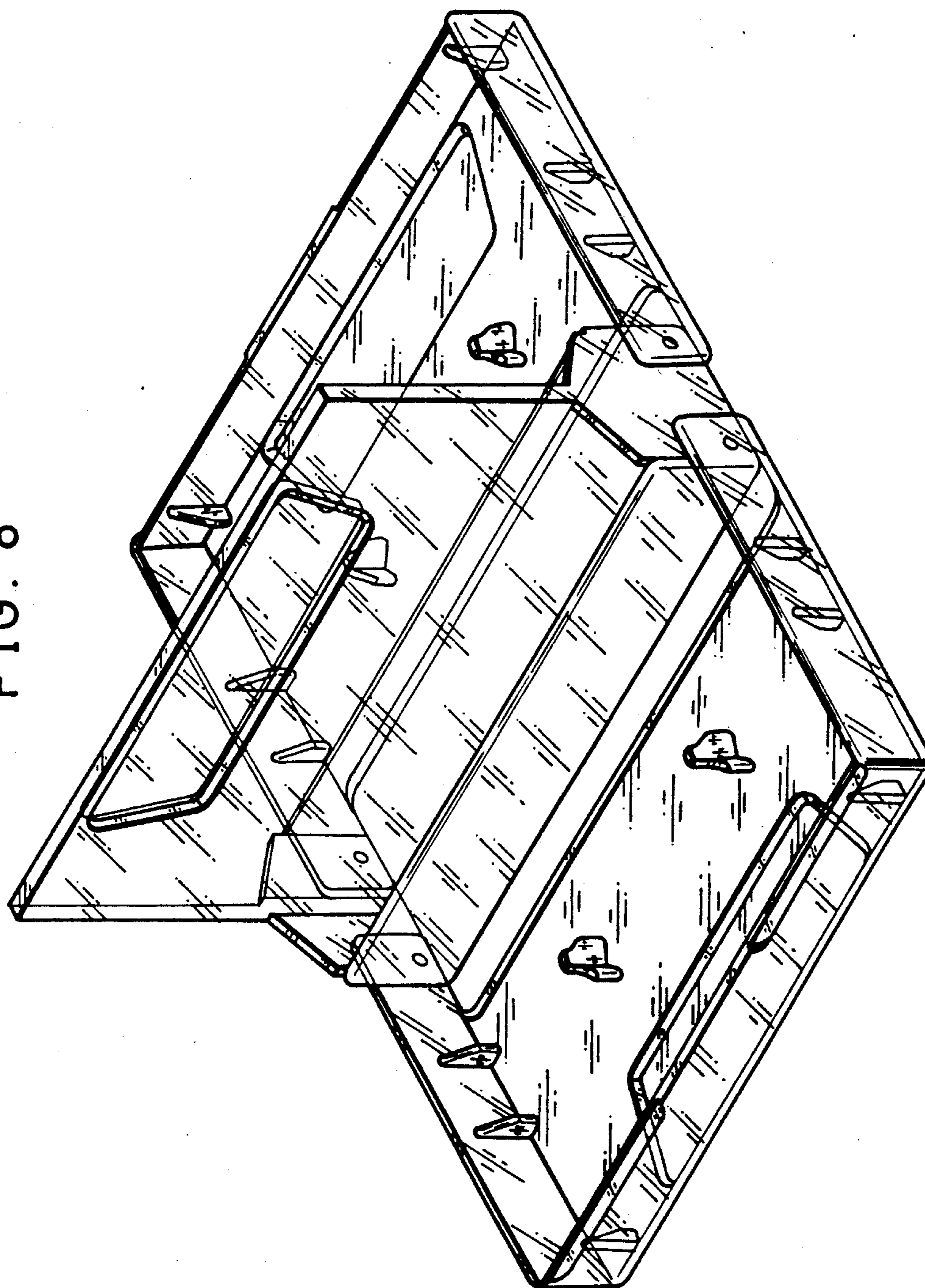

FIG. 9

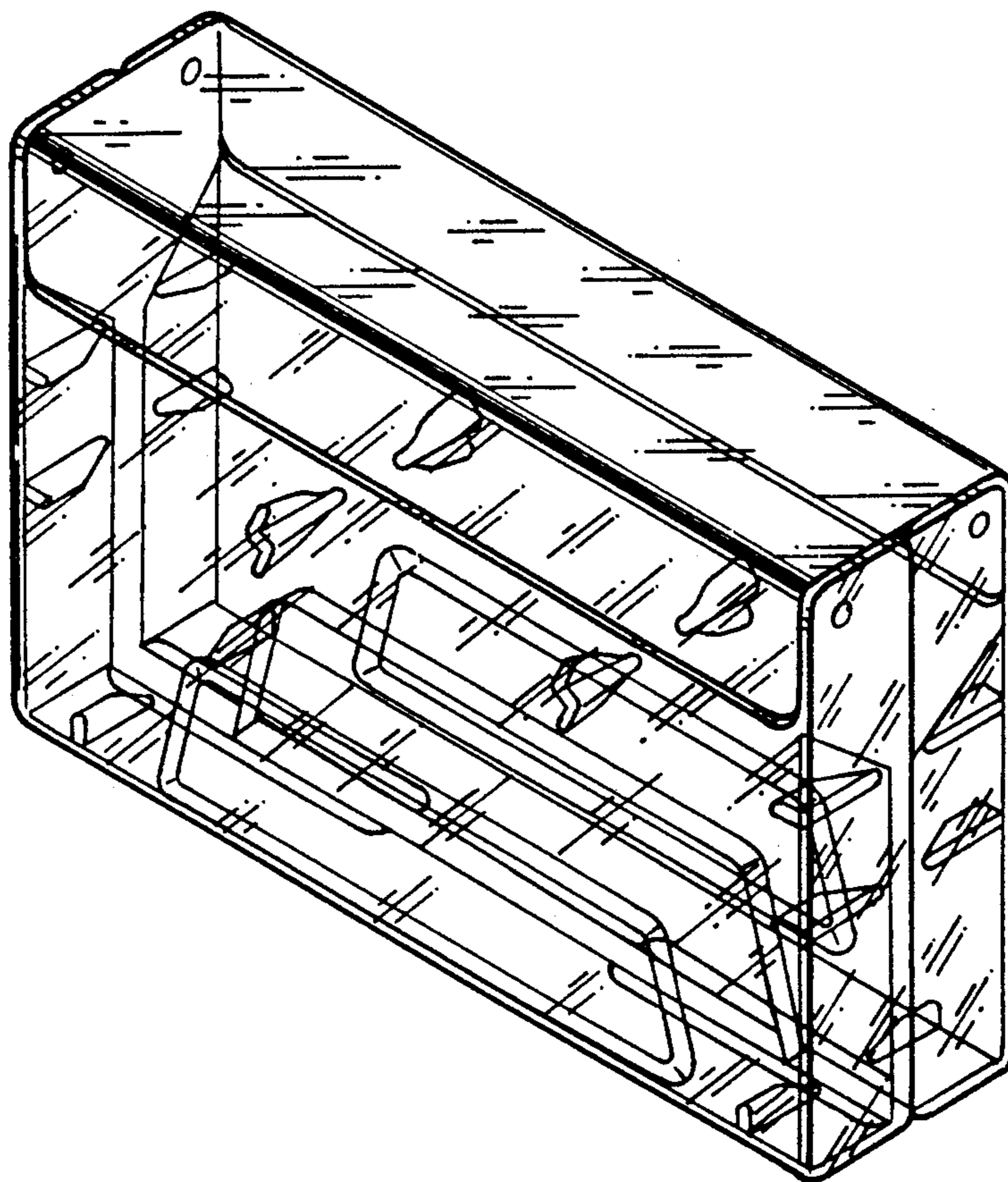

FIG. 10

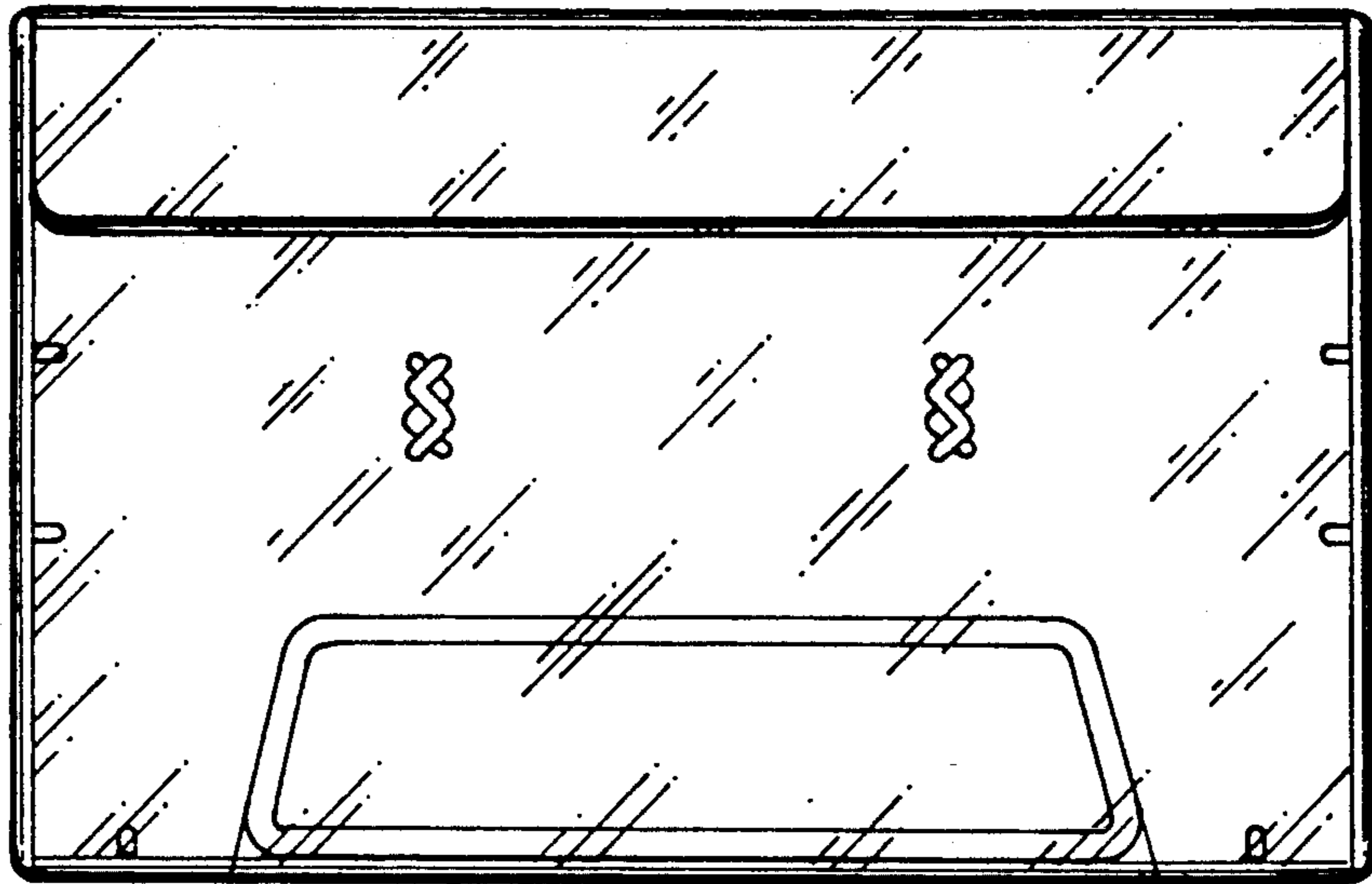

FIG. 11

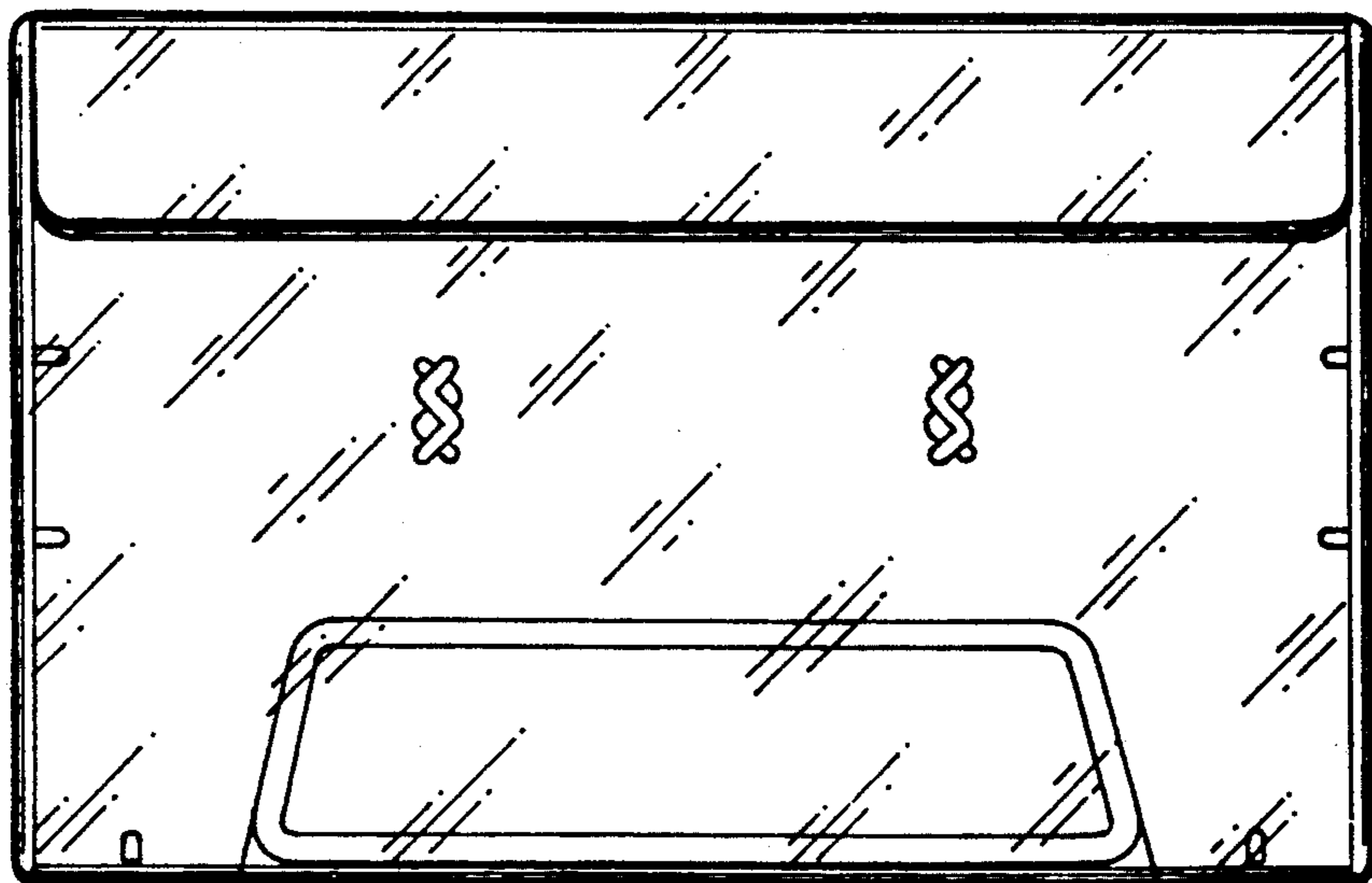

FIG. 12

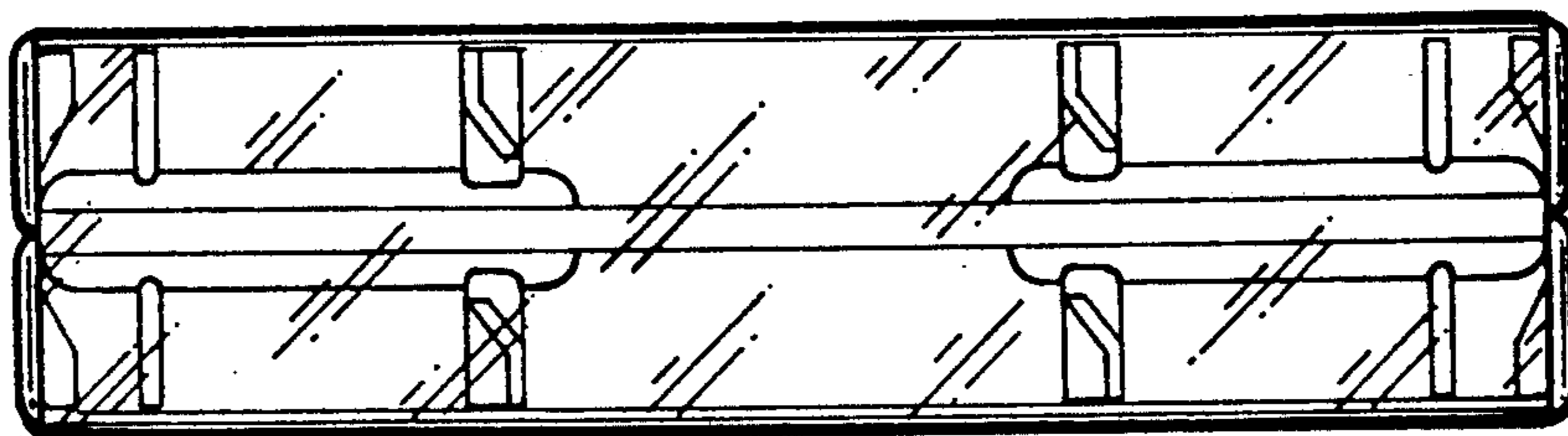

FIG. 13

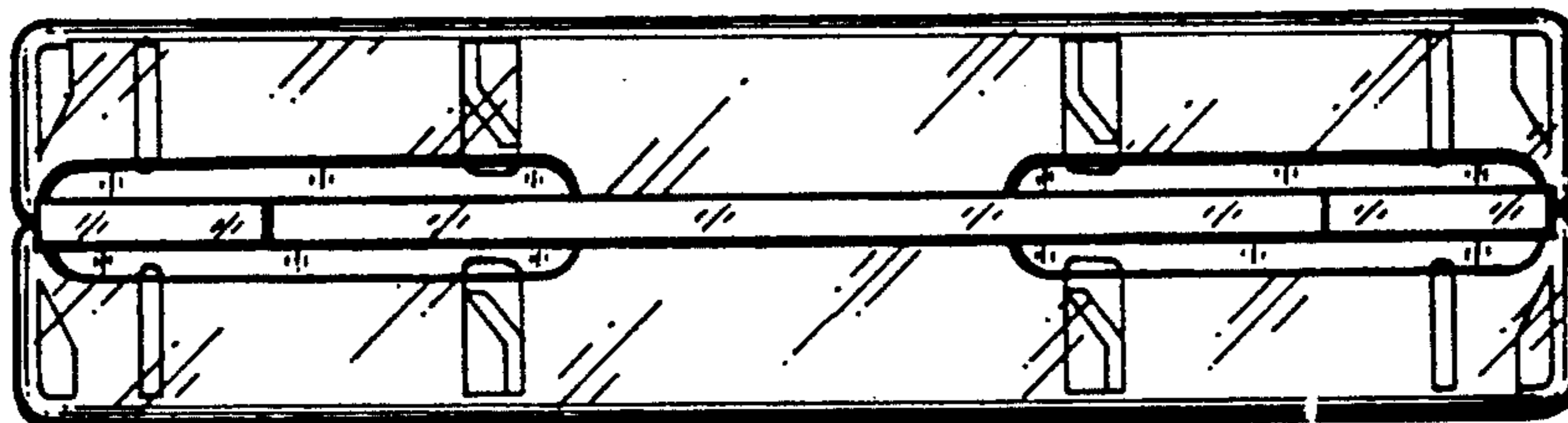

FIG. 14

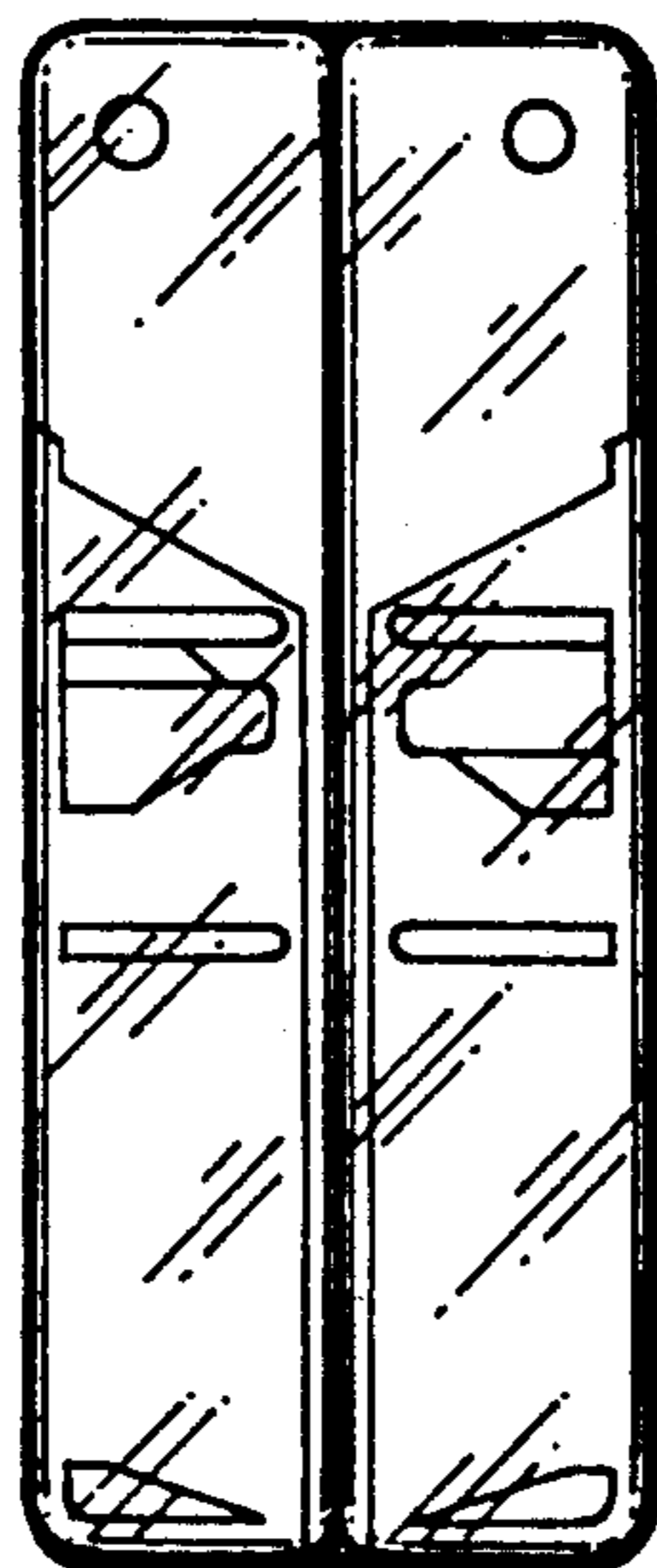

FIG. 15

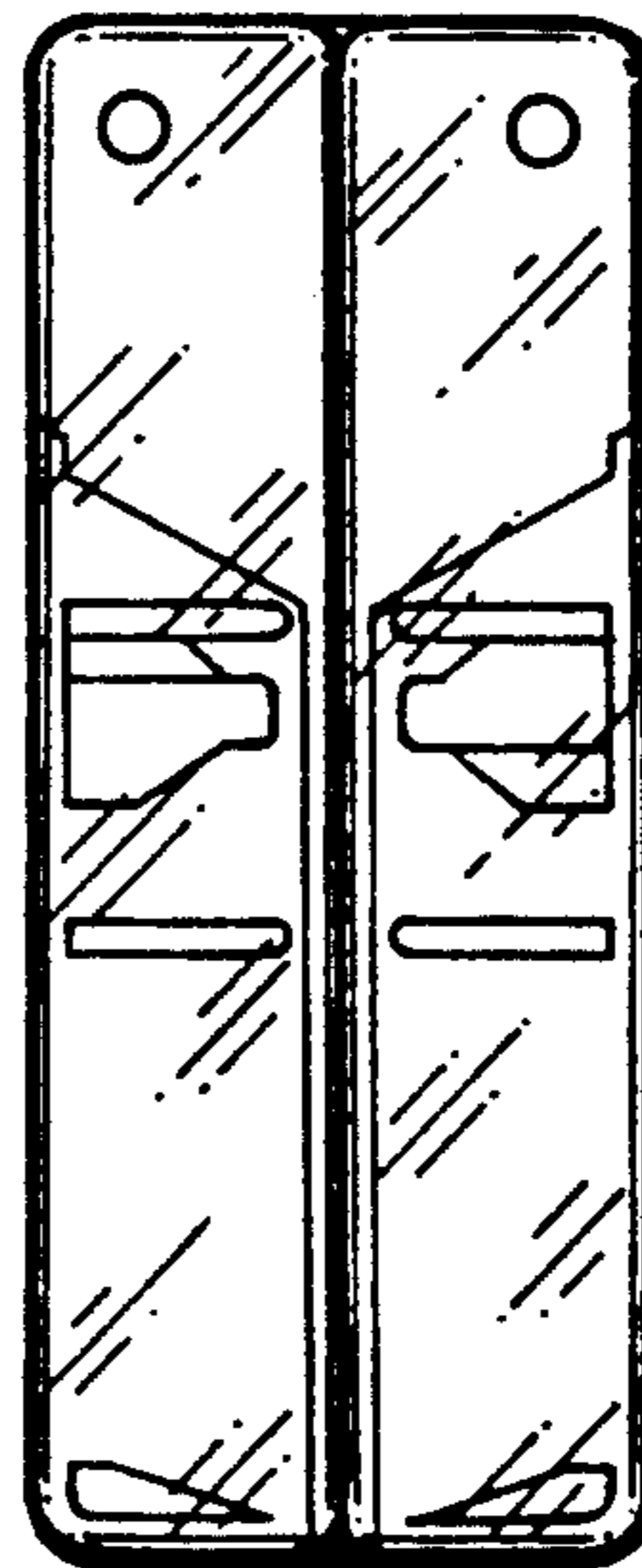

FIG. 16

