



US00D334237S

# United States Patent [19]

[11] Patent Number: **Des. 334,237**

Collister et al.

[45] Date of Patent: **\*\* Mar. 23, 1993**

[54] **DRAGNOSTIC IMMUNOASSAY ANALYZER**

[75] Inventors: **Kenneth D. Collister, Elkhart, Ind.;**  
**Michael Paloian, Babylon Village,**  
**N.Y.**

[73] Assignee: **Miles Inc., Elkhart, Ind.**

[\*\*] Term: **14 Years**

[21] Appl. No.: **661,101**

[22] Filed: **Feb. 26, 1991**

[52] U.S. Cl. .... **D24/232; D24/186;**  
**D10/81**

[58] Field of Search ..... **D24/186, 216, 231, 232;**  
**D10/81; 422/63, 64, 65, 66, 67, 68.1, 99, 100;**  
**436/43; 356/244, 246**

[56] **References Cited**

**U.S. PATENT DOCUMENTS**

D. 251,774 5/1979 Olson et al. .... D10/81  
D. 272,087 1/1984 Smith ..... D24/216

D. 305,684 1/1990 Kawewske, III et al. .... D24/186  
D. 307,321 4/1990 Bransky et al. .... D24/186  
5,051,238 9/1991 Umetsu et al. .... 422/67 X  
5,089,229 2/1992 Heidt et al. .... 422/63 X

*Primary Examiner*—Stella Reid  
*Assistant Examiner*—I. Simmons  
*Attorney, Agent, or Firm*—Roger N. Coe

[57] **CLAIM**

The ornamental design for a diagnostic immunoassay analyzer, as shown and described.

**DESCRIPTION**

FIG. 1 is a front perspective view of a diagnostic immunoassay analyzer showing my new design; FIG. 2 is a top plan view thereof; FIG. 3 is a front elevational view thereof; FIG. 4 is a rear elevational view thereof; FIG. 5 is a bottom plan view thereof; FIG. 6 is a right side elevational view thereof; and, FIG. 7 is a left side elevational view thereof.

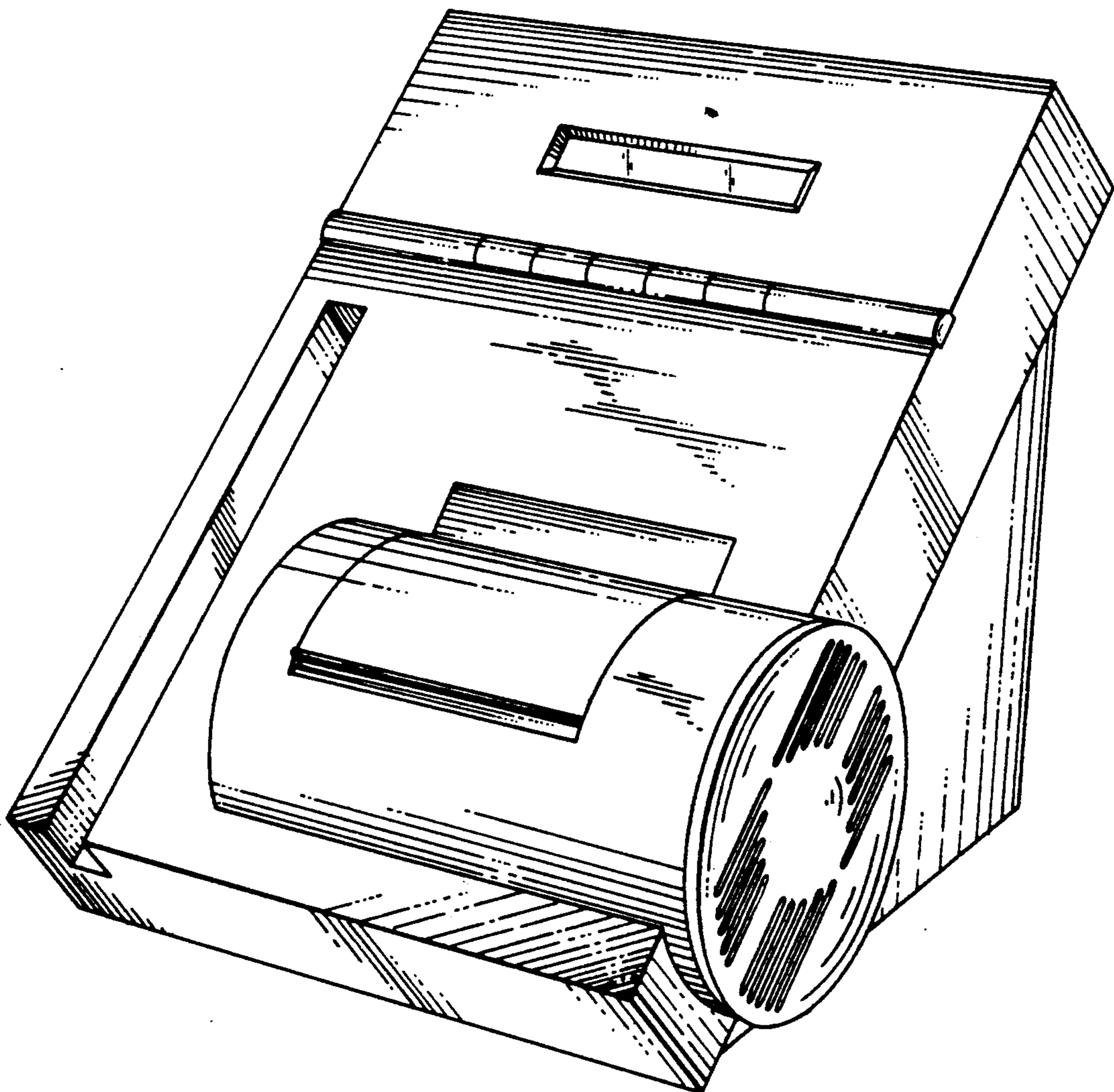

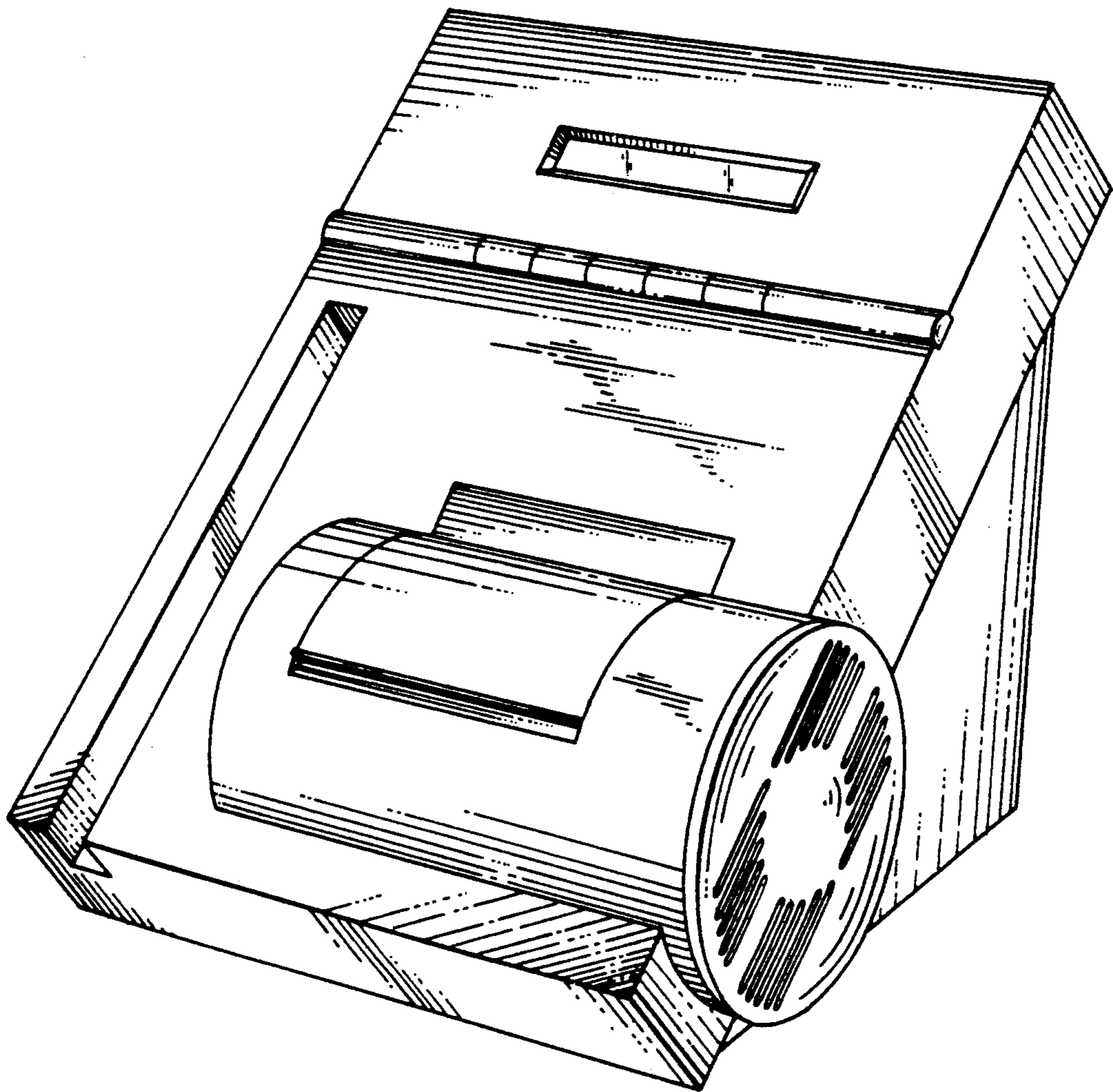

FIG. 1

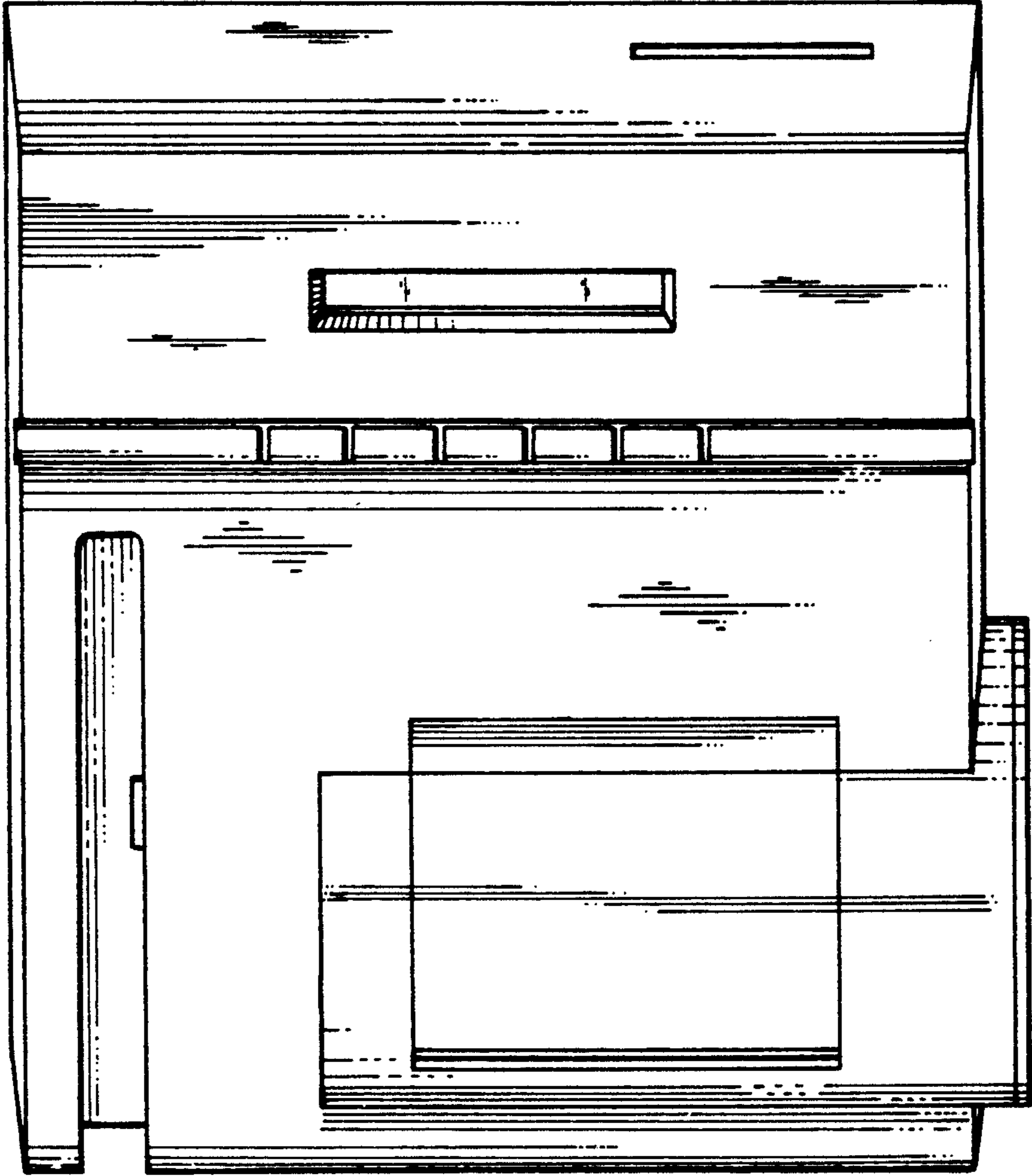

FIG. 2

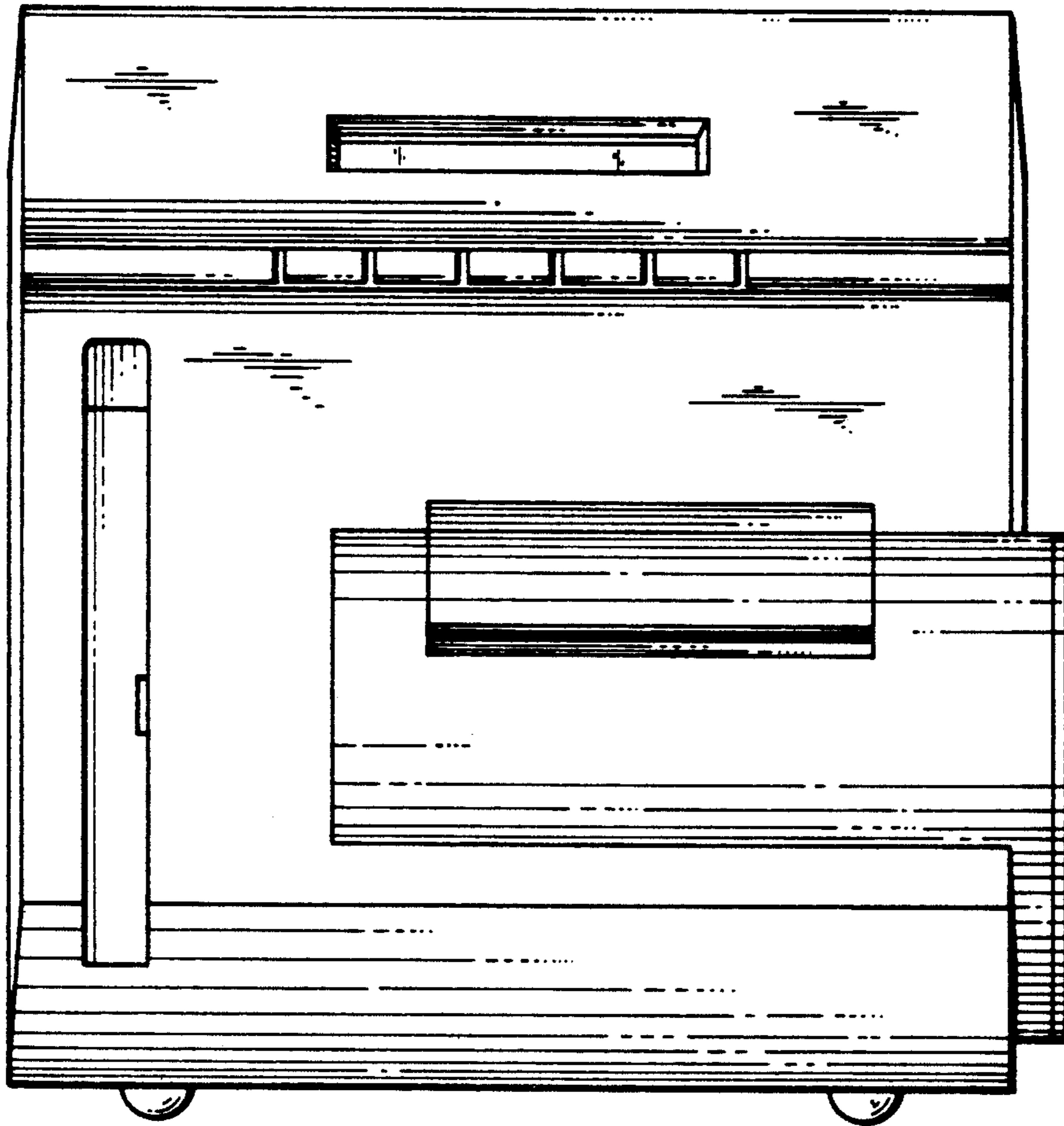

FIG. 3

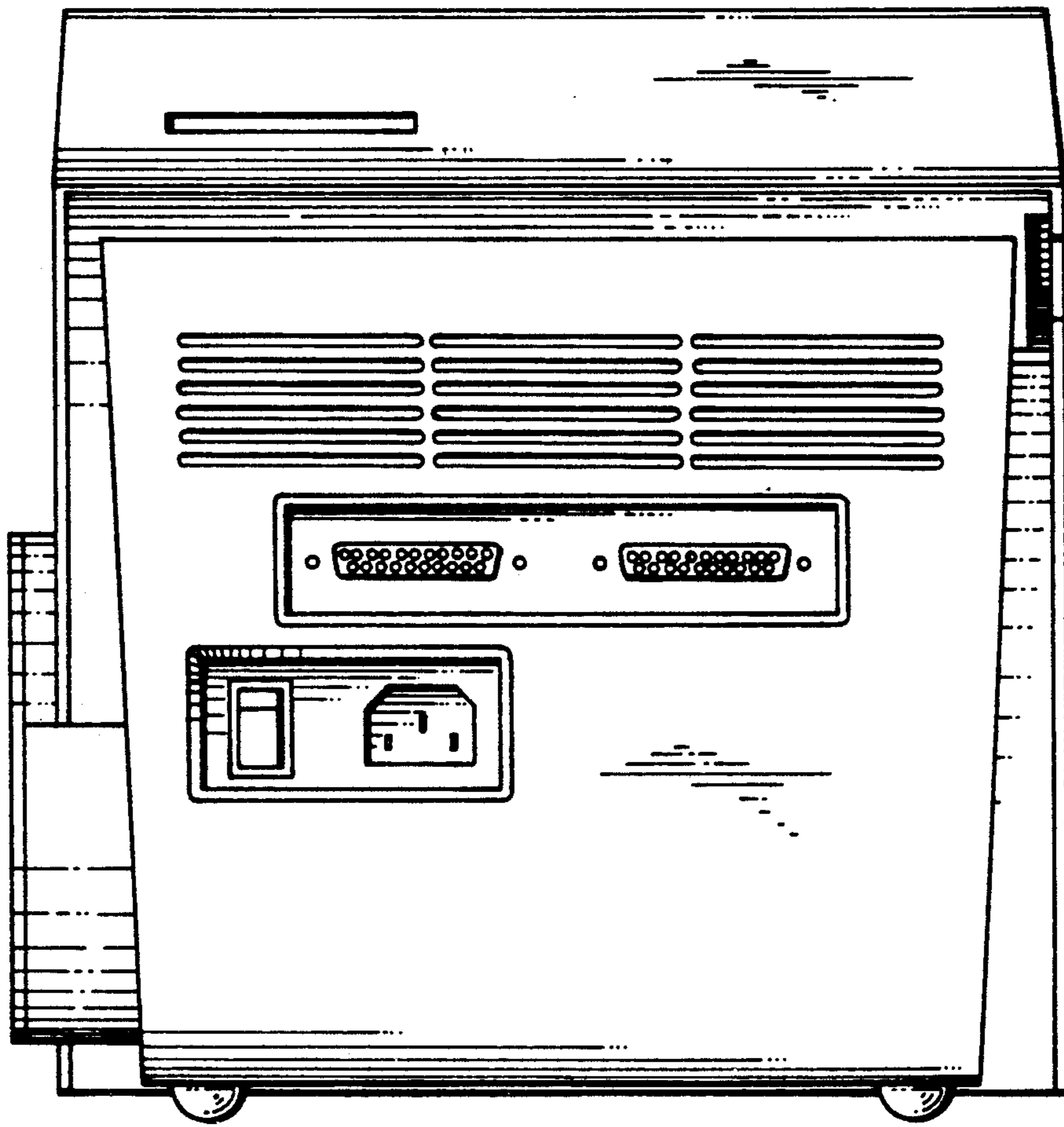

FIG. 4

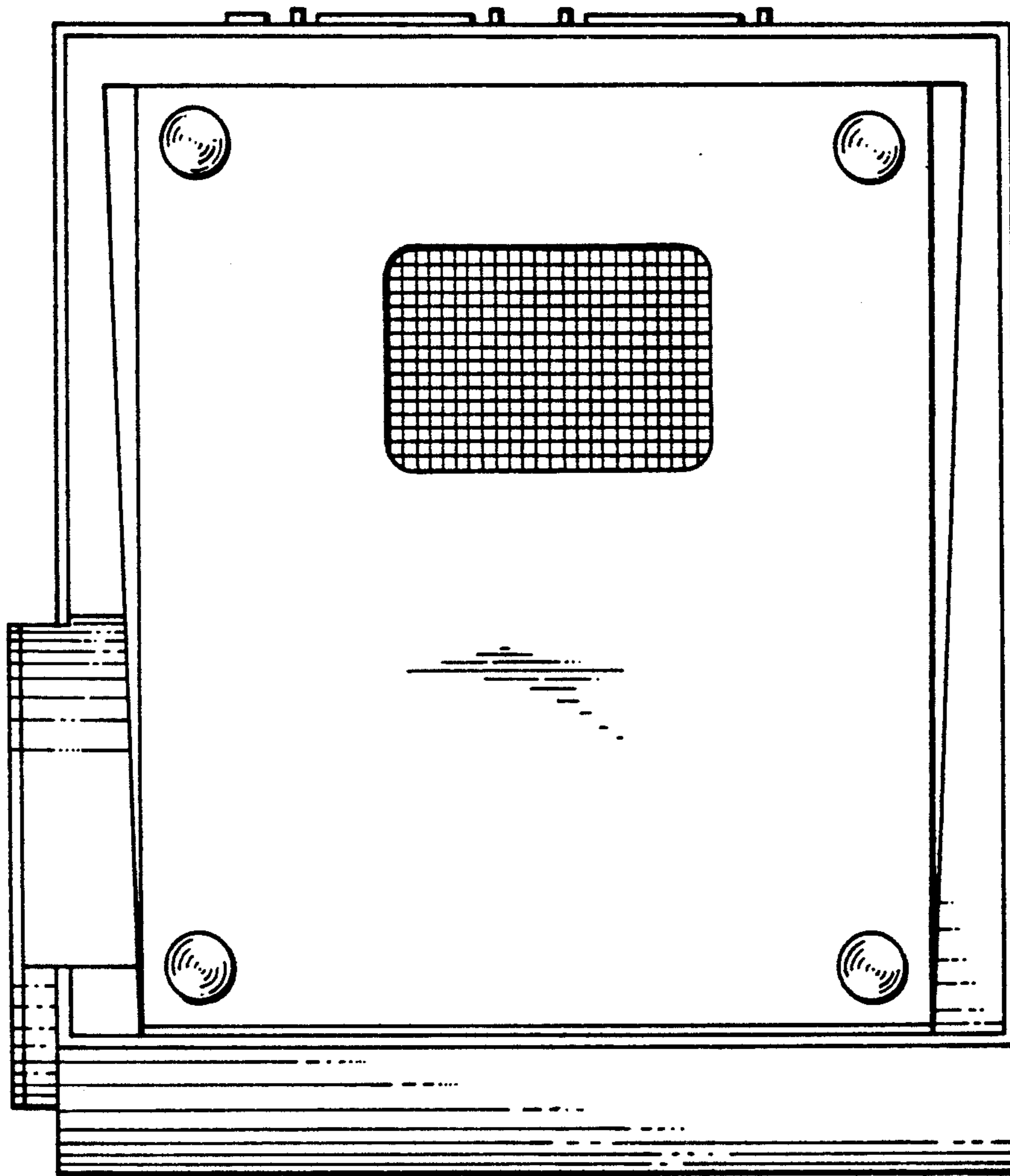

FIG. 5

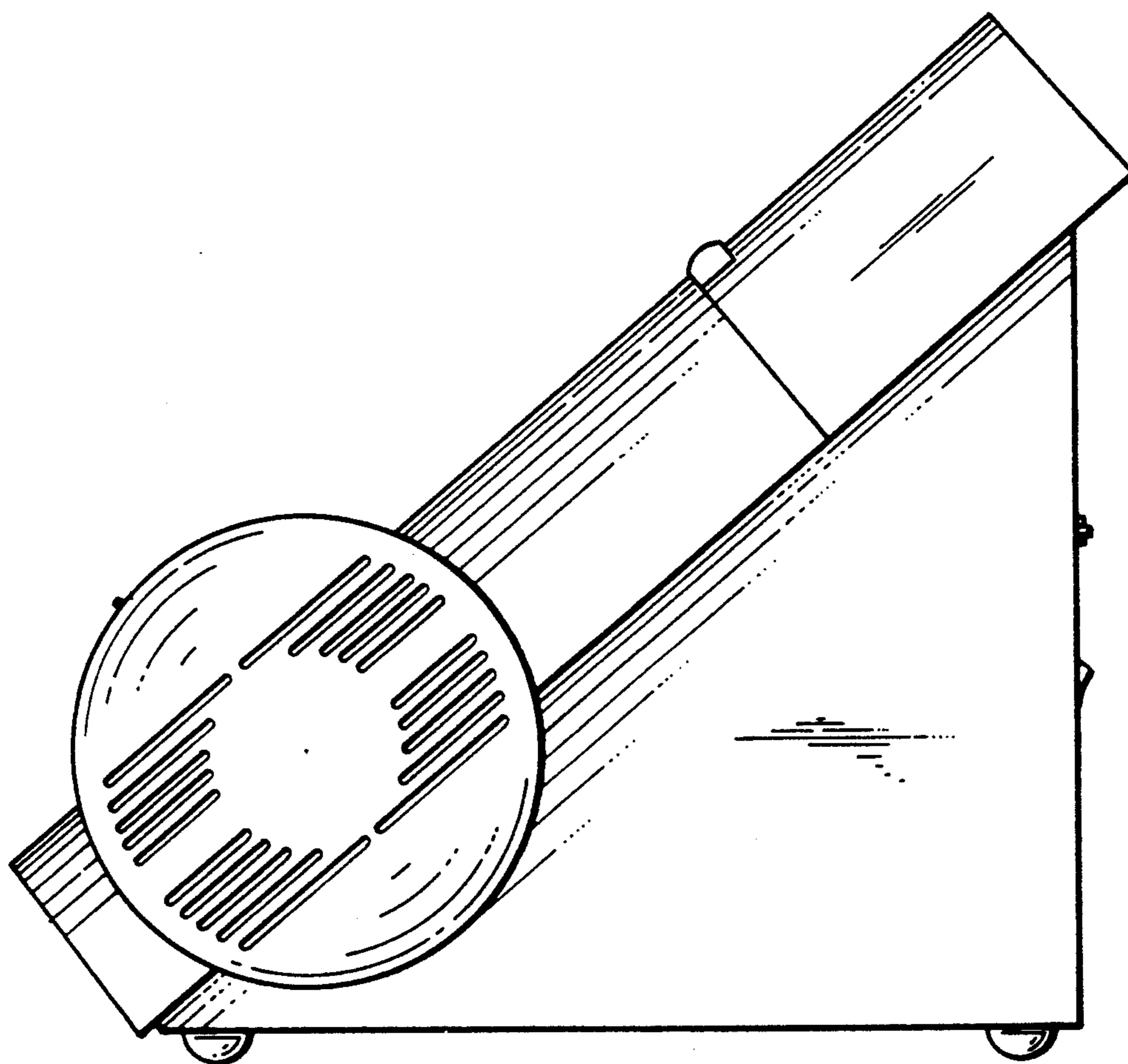

FIG. 6

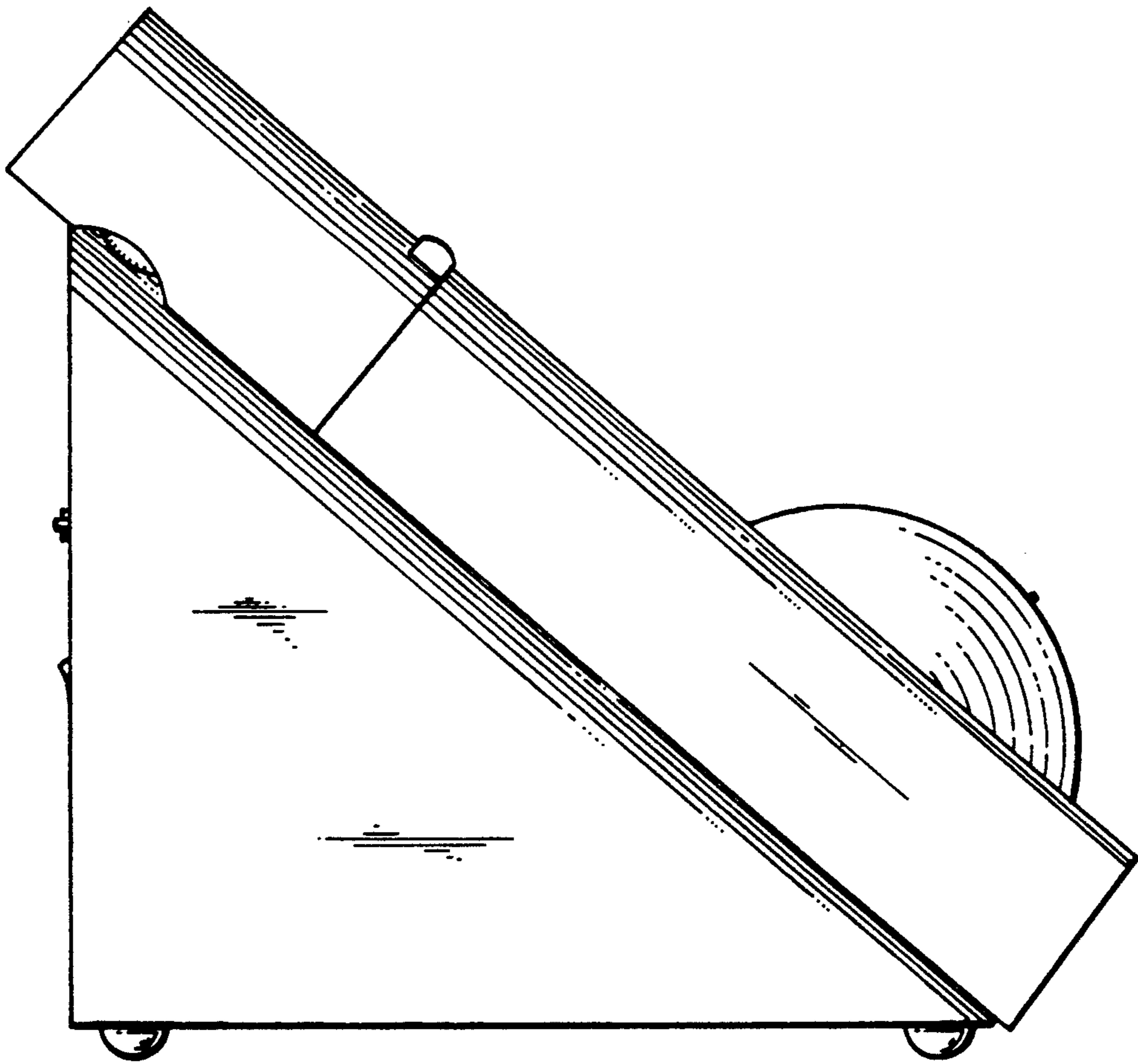

FIG. 7



UNITED STATES PATENT AND TRADEMARK OFFICE  
**CERTIFICATE OF CORRECTION**

PATENT NO. : Des. 334,237

DATED : Mar. 23, 1993

INVENTOR(S) : Kenneth D. Collister and Michael Paloian

It is certified that error appears in the above-identified patent and that said Letters Patent is hereby corrected as shown below:

On the title page, item (54):

Title should be changed to read:

DIAGNOSTIC IMMUNOASSAY ANALYZER

Signed and Sealed this

Twenty-eighth Day of June, 1994

Attest:



BRUCE LEHMAN

Attesting Officer

Commissioner of Patents and Trademarks