



US00D334182S

United States Patent [19]

[11] Patent Number: **Des. 334,182**

Mizusugi et al.

[45] Date of Patent: **** Mar. 23, 1993**

[54] **COMPUTER**

D. 327,474 6/1992 Lee D14/106

[75] Inventors: **Kanji Mizusugi; Kensho Tsuji; Hiroshi Yamamizu**, all of Nara, Japan

Primary Examiner—Wallace R. Burke
Assistant Examiner—Freda S. Nunn
Attorney, Agent, or Firm—Nixon & Vanderhye

[73] Assignee: **Sharp Kabushiki Kaisha**, Osaka, Japan

[57] CLAIM

[**] Term: **14 Years**

The ornamental design for a computer, as shown and described.

[21] Appl. No.: **691,320**

DESCRIPTION

[22] Filed: **Apr. 26, 1991**

[30] Foreign Application Priority Data

Oct. 26, 1990 [JP] Japan 2-35875
[52] U.S. Cl. **D14/106**
[58] Field of Search D14/100, 101, 106, 113, D14/115; D18/1, 7, 11, 12; 235/145 A, 145 R; 340/700, 706; 341/22, 23; 361/390, 394; 364/708, 709.04

FIG. 1 is an enlarged top front and right side perspective view of a computer showing our new design in the opened position;
FIG. 2 is a top plan view thereof;
FIG. 3 is a front elevational view thereof;
FIG. 4 is a right side elevational view thereof;
FIG. 5 is a rear elevational view thereof;
FIG. 6 is a left side elevational view thereof;
FIG. 7 is a bottom plan view thereof;
FIG. 8 is a top plan view thereof shown in the closed position;
FIG. 9 is a front elevational view thereof;
FIG. 10 is a right side elevational view thereof;
FIG. 11 is a rear elevational view thereof;
FIG. 12 is a left side elevational view thereof; and,
FIG. 13 is a bottom plan view thereof.

[56] References Cited

U.S. PATENT DOCUMENTS

D. 313,978 1/1991 Miyakuni D14/106
D. 316,706 5/1991 Imamura et al. D14/106
D. 324,674 3/1992 Iino D14/106

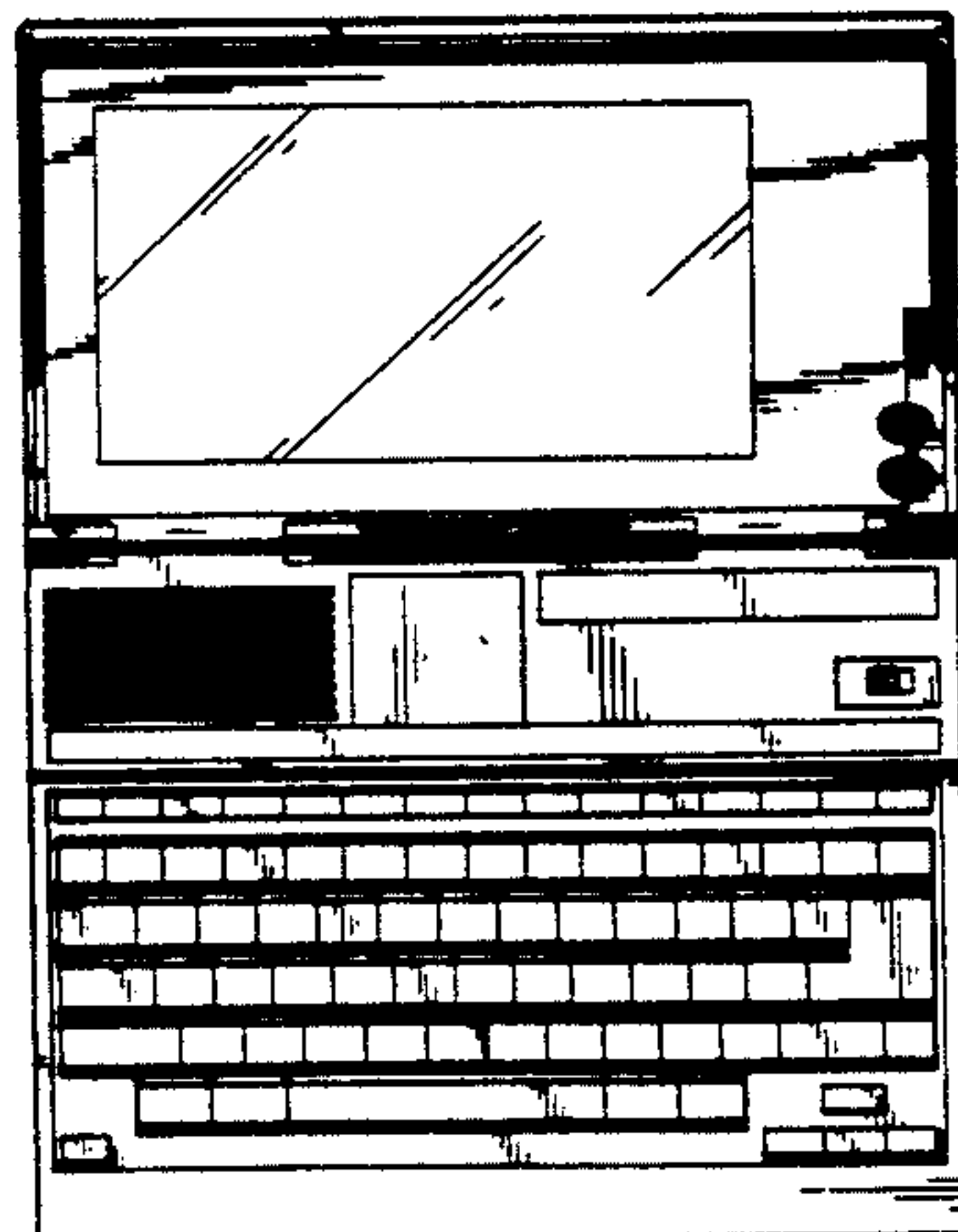
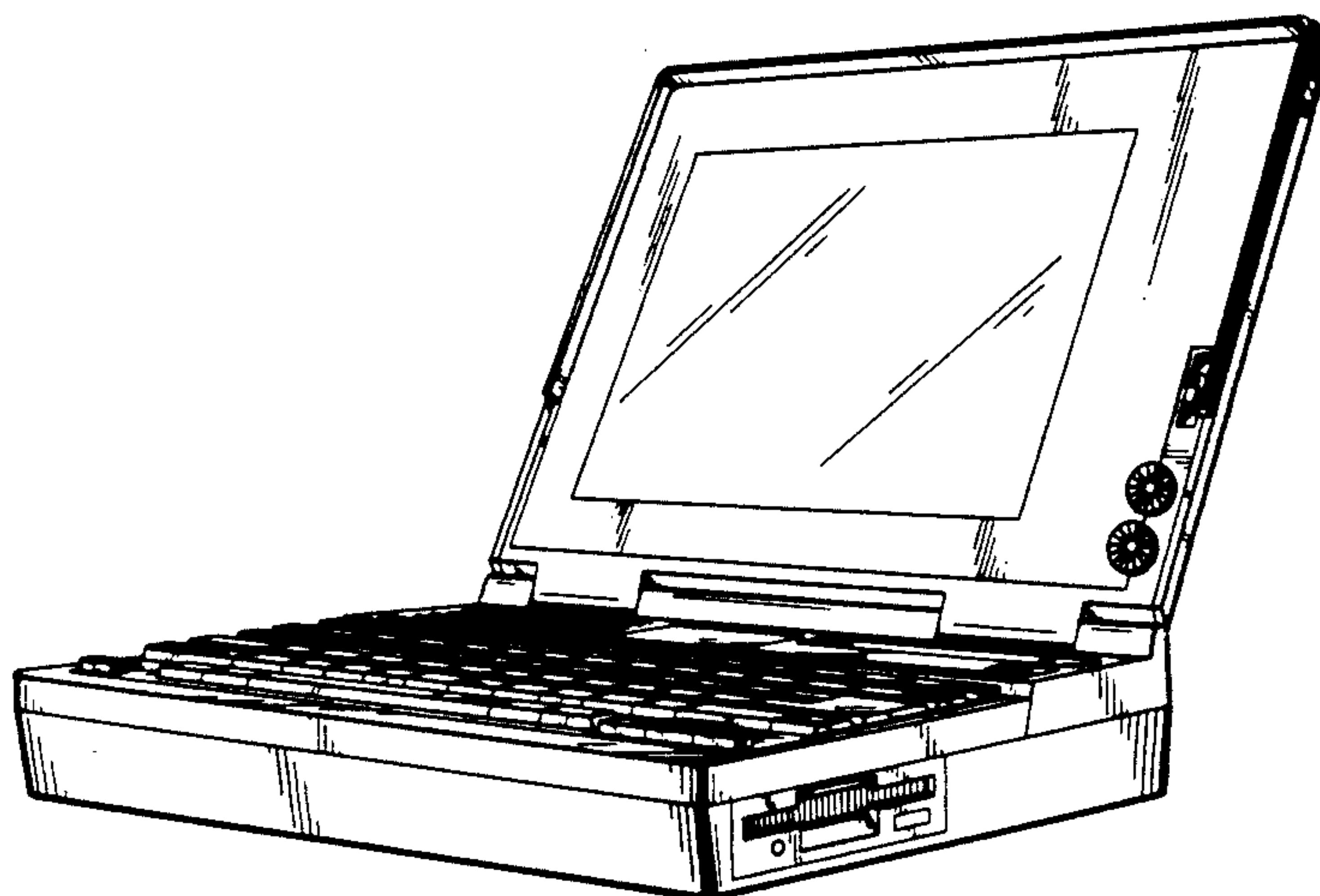

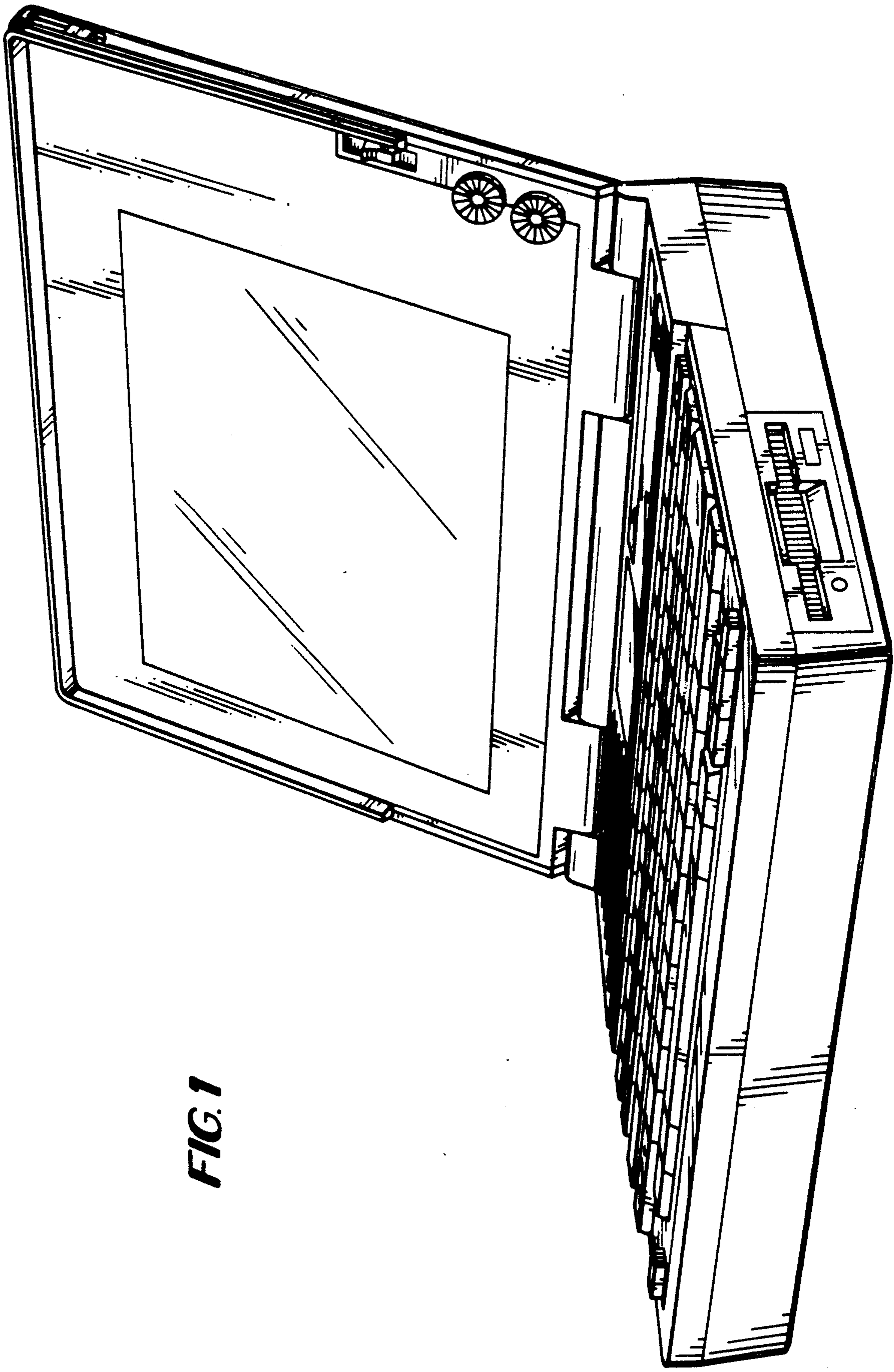

FIG. 1

FIG. 2

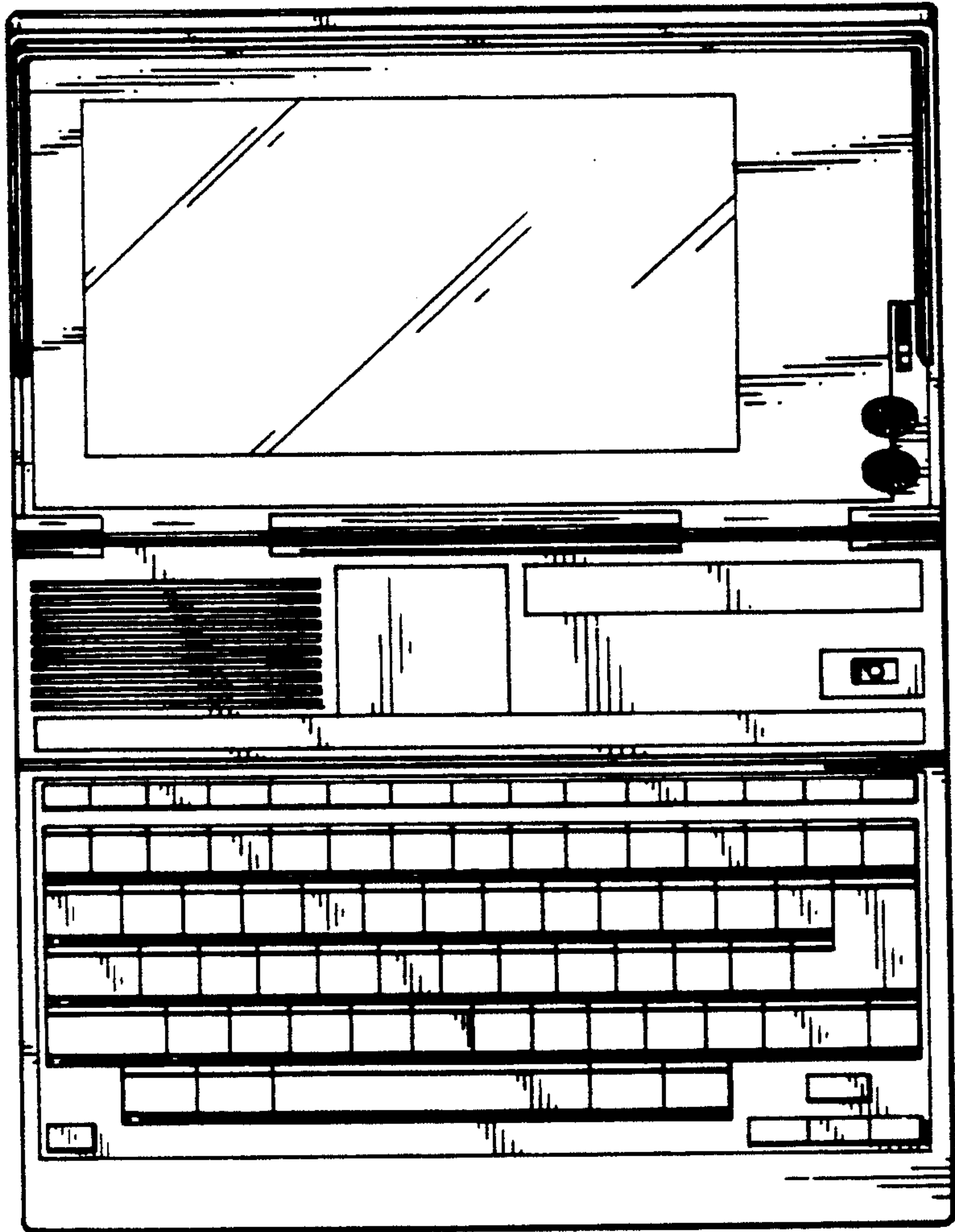
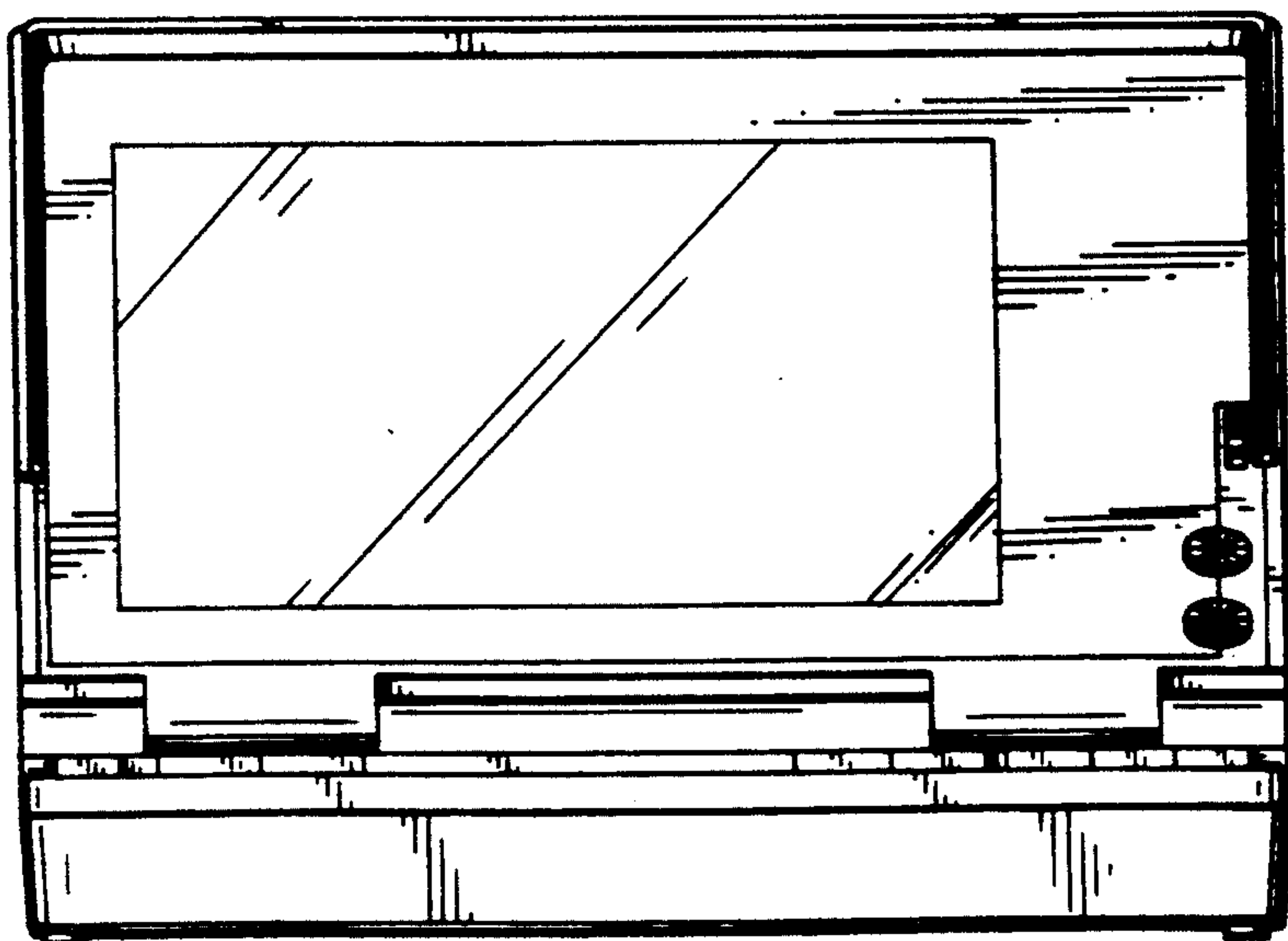

FIG. 3



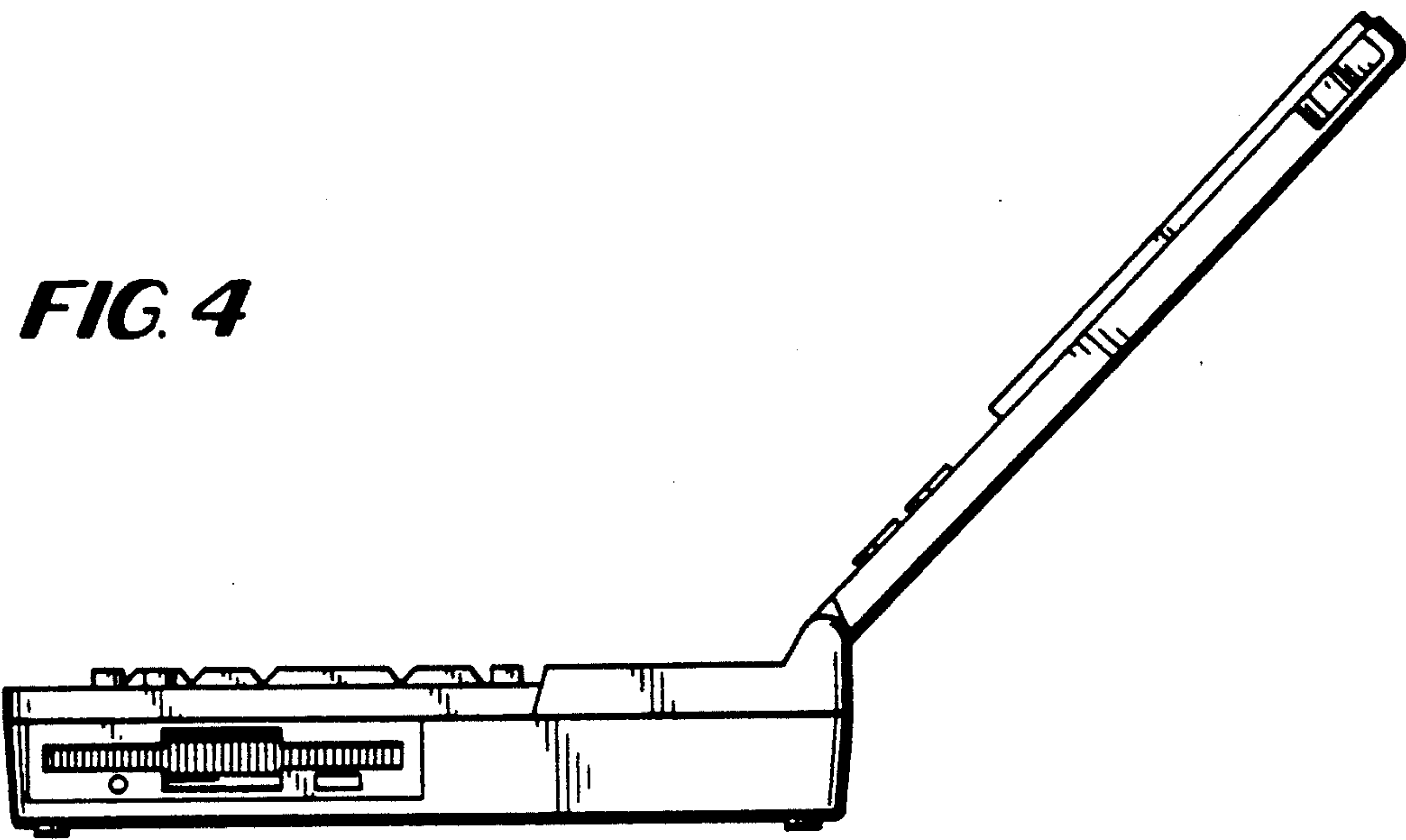
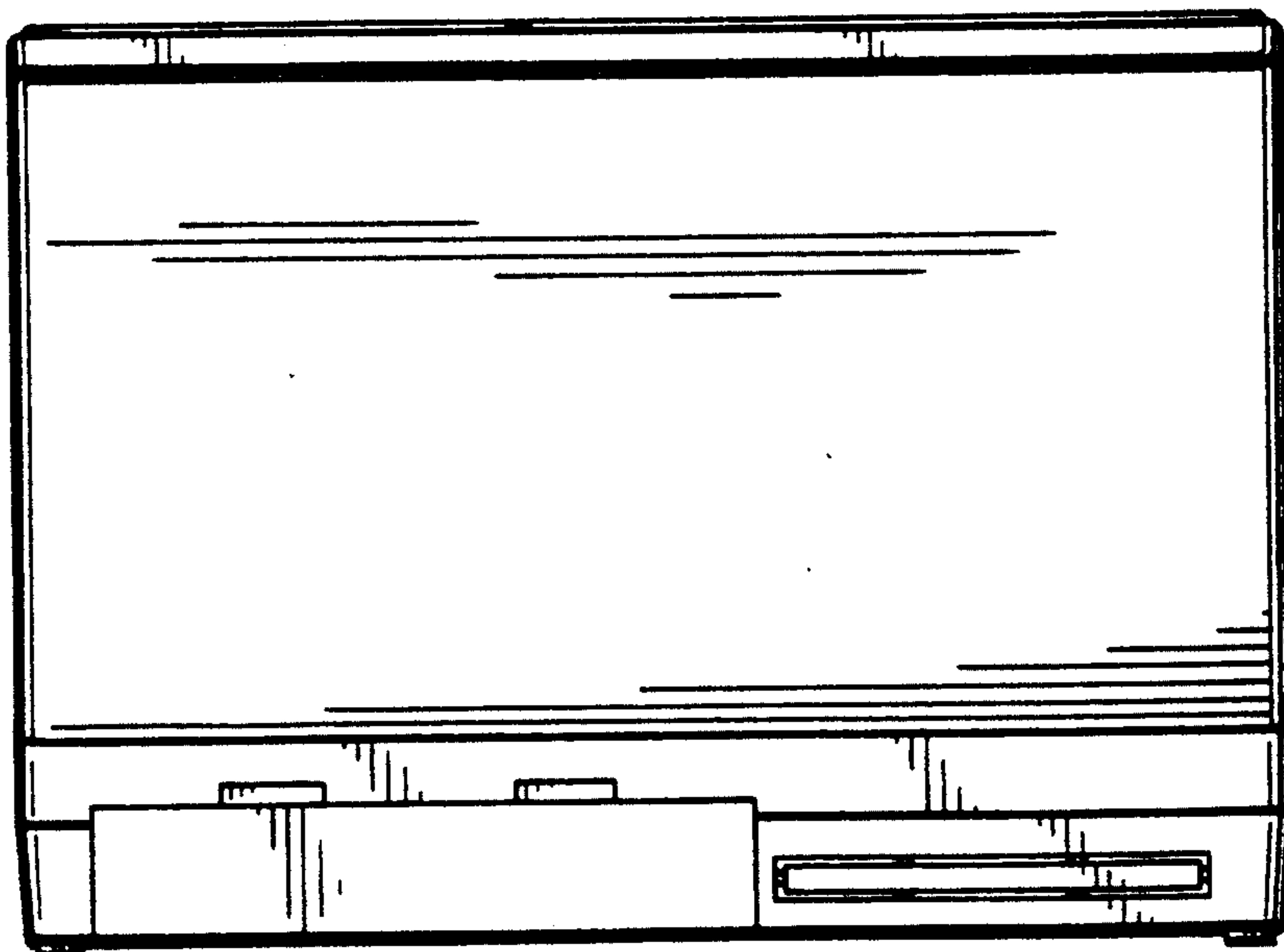

FIG. 5



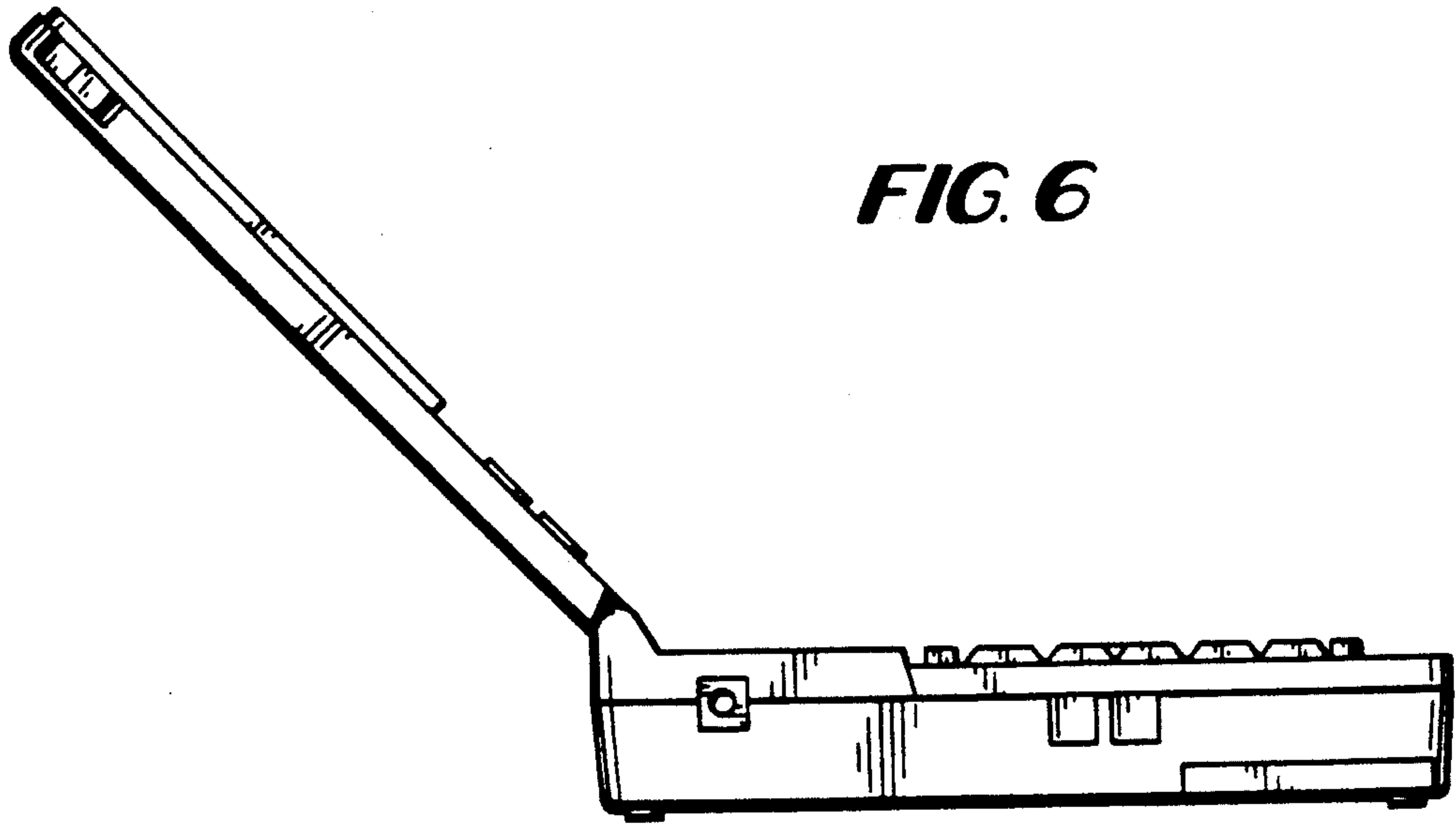

FIG. 6

FIG. 7

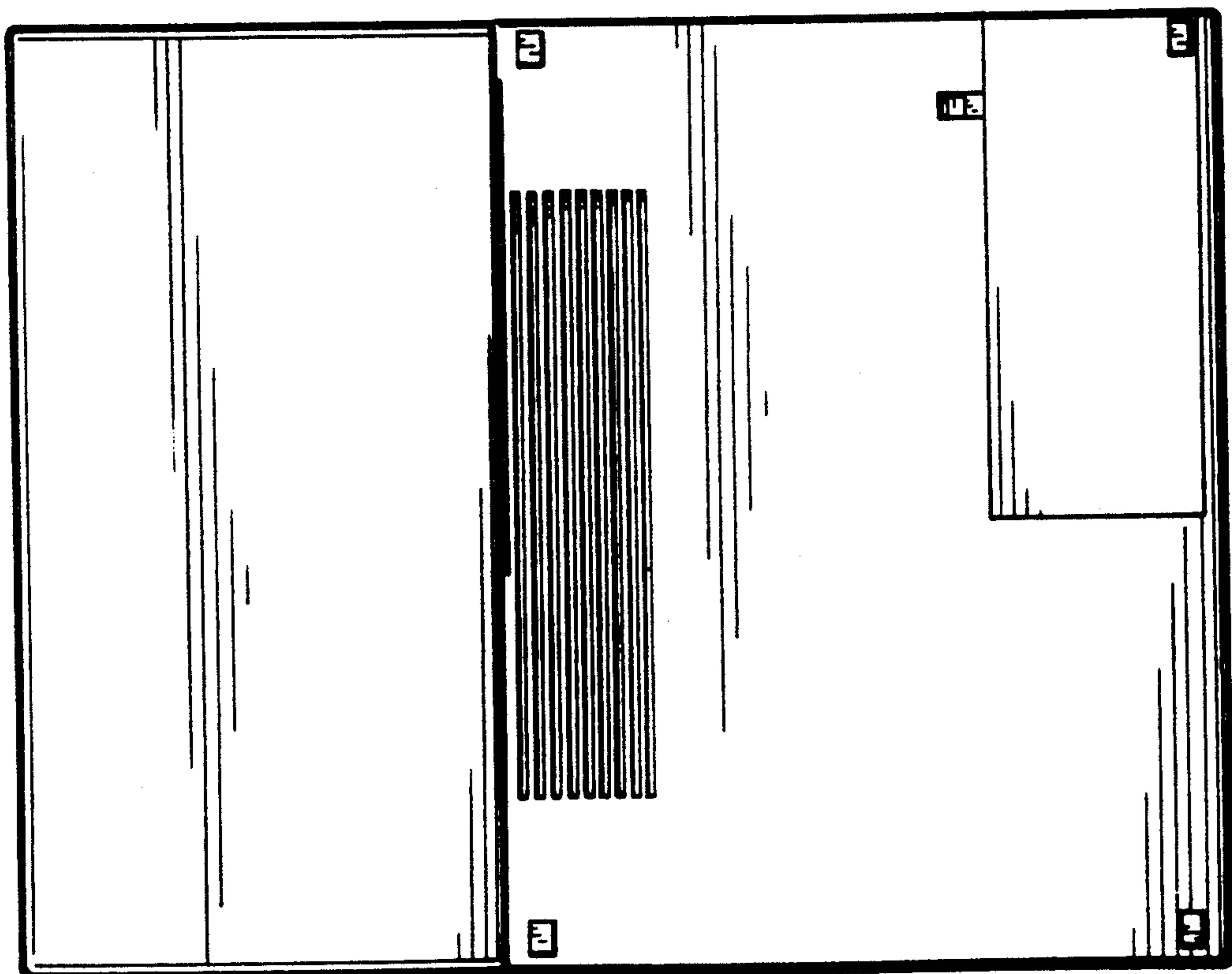

FIG. 8

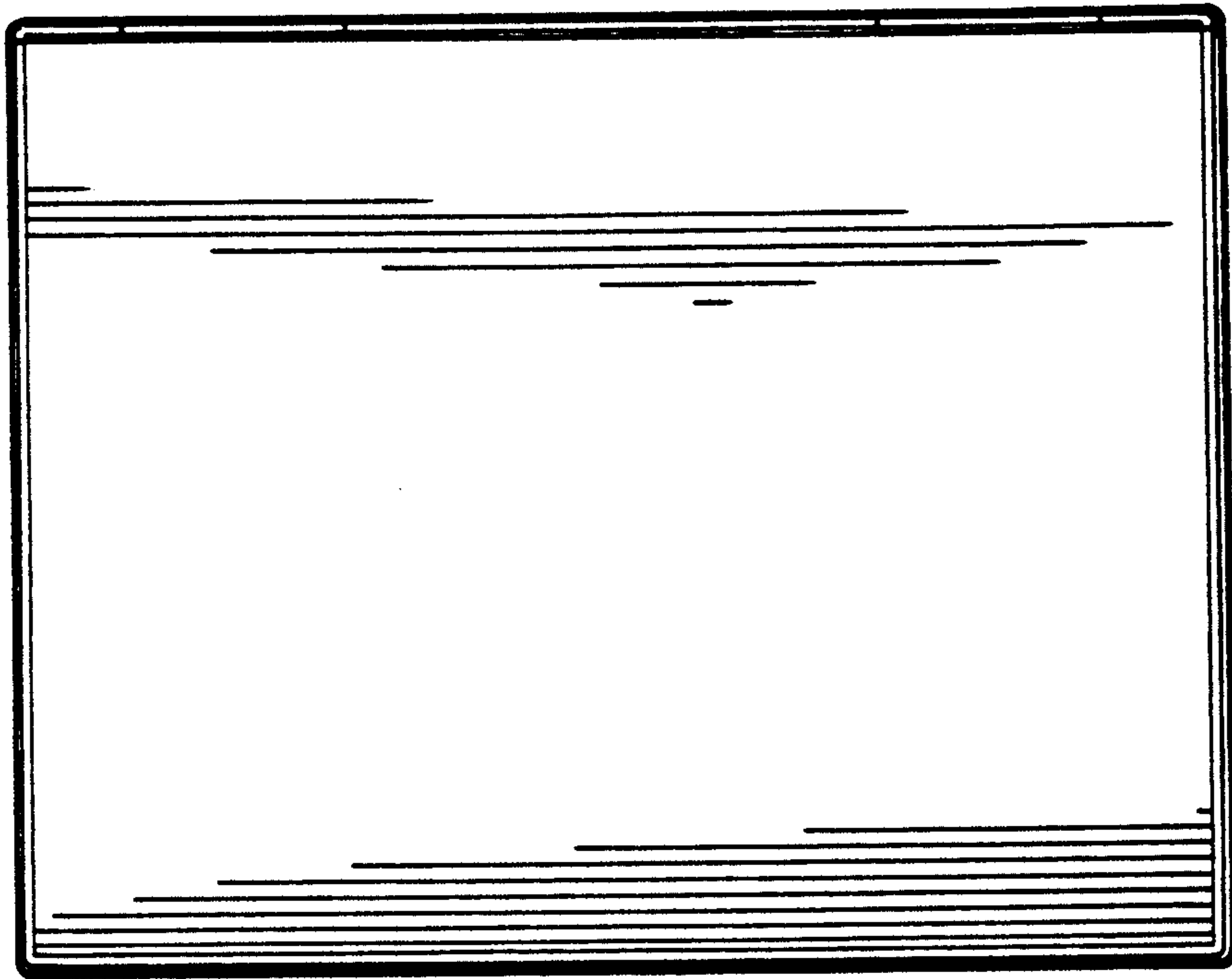
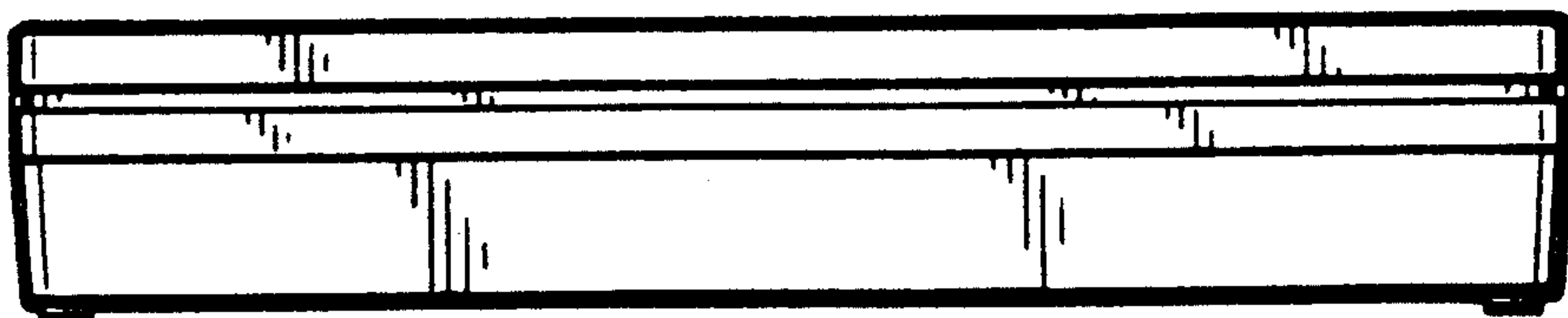

FIG. 9



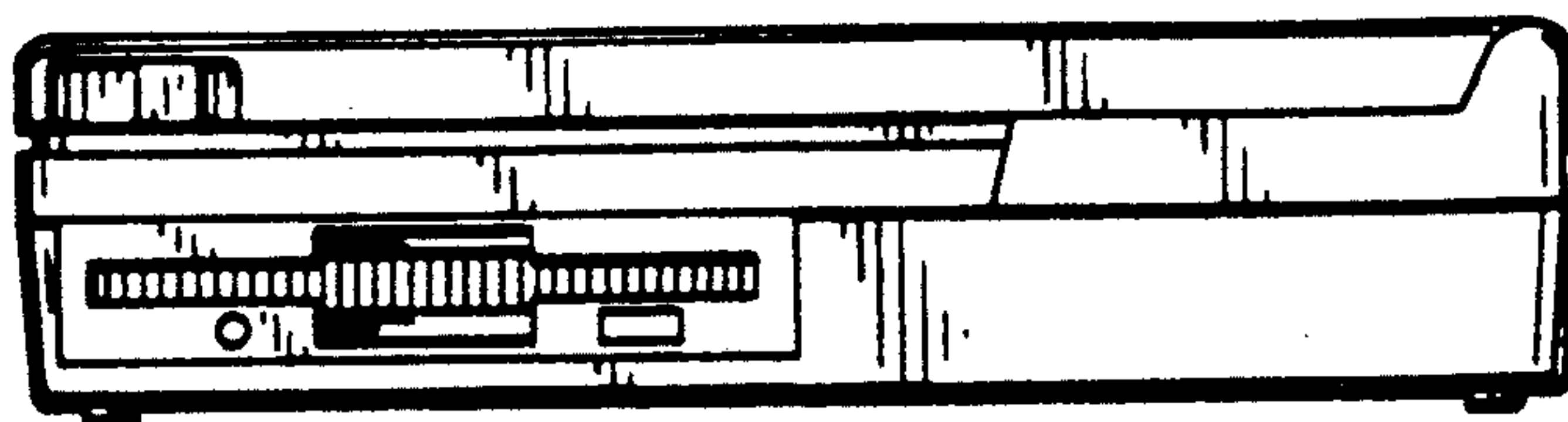

FIG. 10

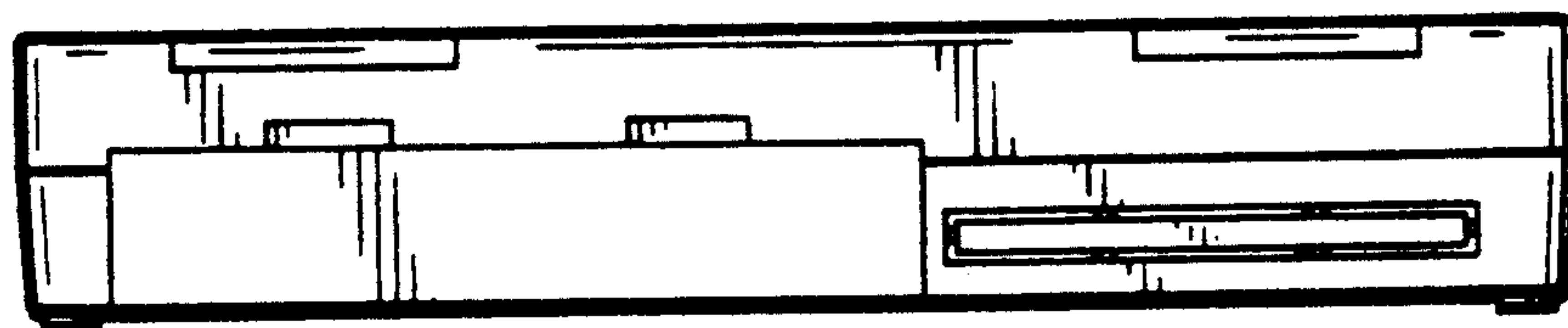

FIG. 11

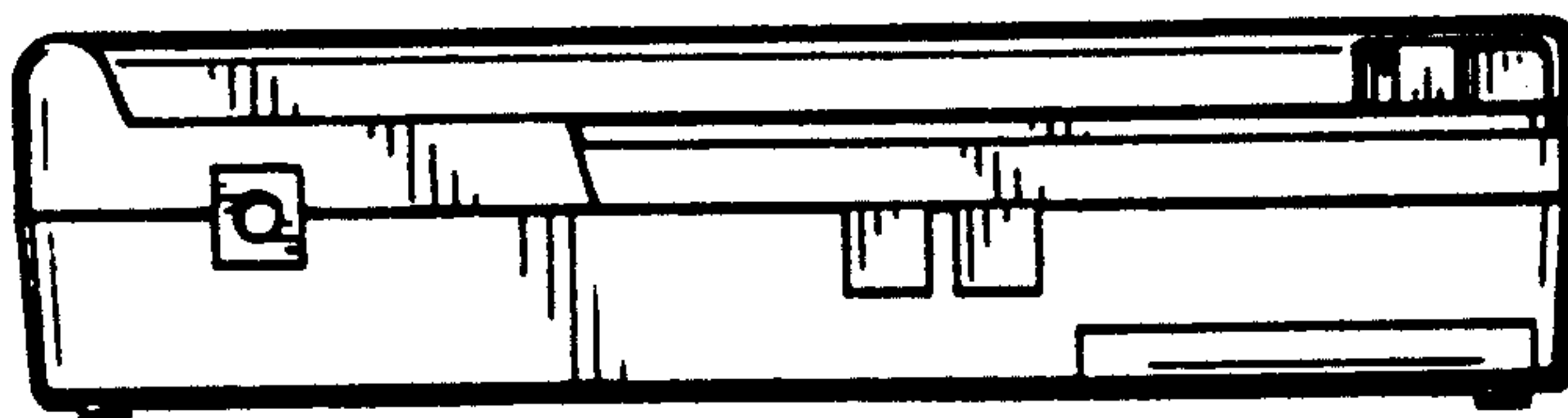

FIG. 12

FIG. 13

