



US00D334131S

# United States Patent [19]

[11] Patent Number: **Des. 334,131**

**Spaulding**

[45] Date of Patent: **\*\* Mar. 23, 1993**

[54] **LOCK ATTACHABLE TO DOOR AND WALL**

### FOREIGN PATENT DOCUMENTS

[76] Inventor: **Ben S. Spaulding**, 1274 Grant Rd.,  
Beaver, Wash. 98305

287647 12/1965 Australia .  
1341283 1/1964 France .

[\*\*] Term: **14 Years**

*Primary Examiner*—Brian N. Vinson  
*Attorney, Agent, or Firm*—Terry M. Gernstein

[21] Appl. No.: **624,265**

### [57] CLAIM

[22] Filed: **Dec. 7, 1990**

The ornamental design for a lock attachable to door and wall, as shown and described.

[52] U.S. Cl. .... **D8/331**

[58] Field of Search ..... **D8/330-331,**  
**D8/333; 292/288, 262, 264, 289**

### DESCRIPTION

### [56] References Cited

#### U.S. PATENT DOCUMENTS

3,788,197 1/1974 Lippman .  
3,836,187 9/1974 Buettner .  
3,999,790 12/1976 Rogen ..... 292/288  
4,155,577 5/1979 Raymond .  
4,648,642 3/1987 Berich .

FIG. 1 is a top, front, and left side perspective view of a lock attachable to door and wall showing my new design;

FIG. 2 is a front elevational view thereof;

FIG. 3 is a rear elevational view thereof;

FIG. 4 is a left side elevational view thereof;

FIG. 5 is a right side elevational view thereof;

FIG. 6 is a top plan view thereof; and,

FIG. 7 is a bottom plan view thereof.

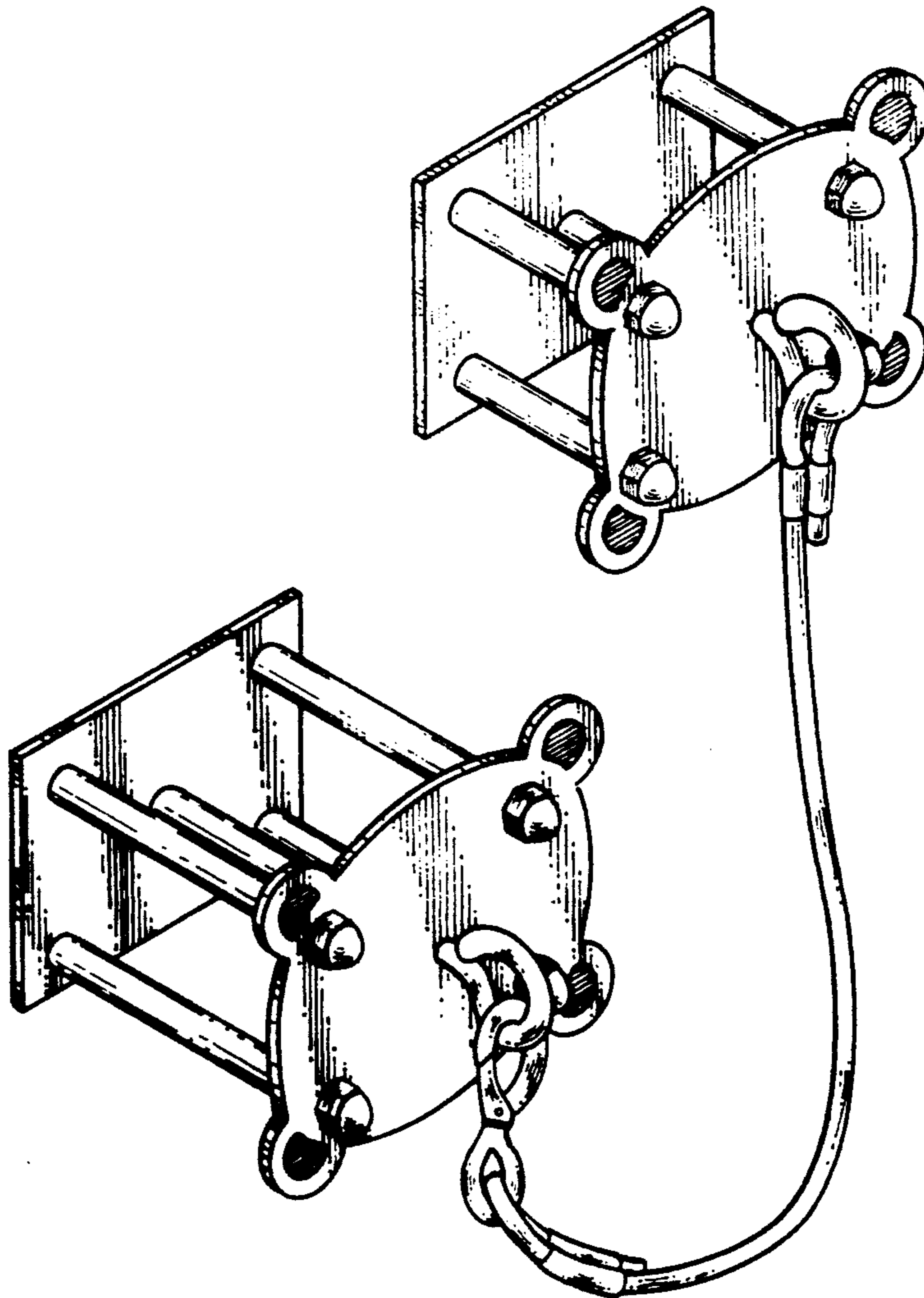

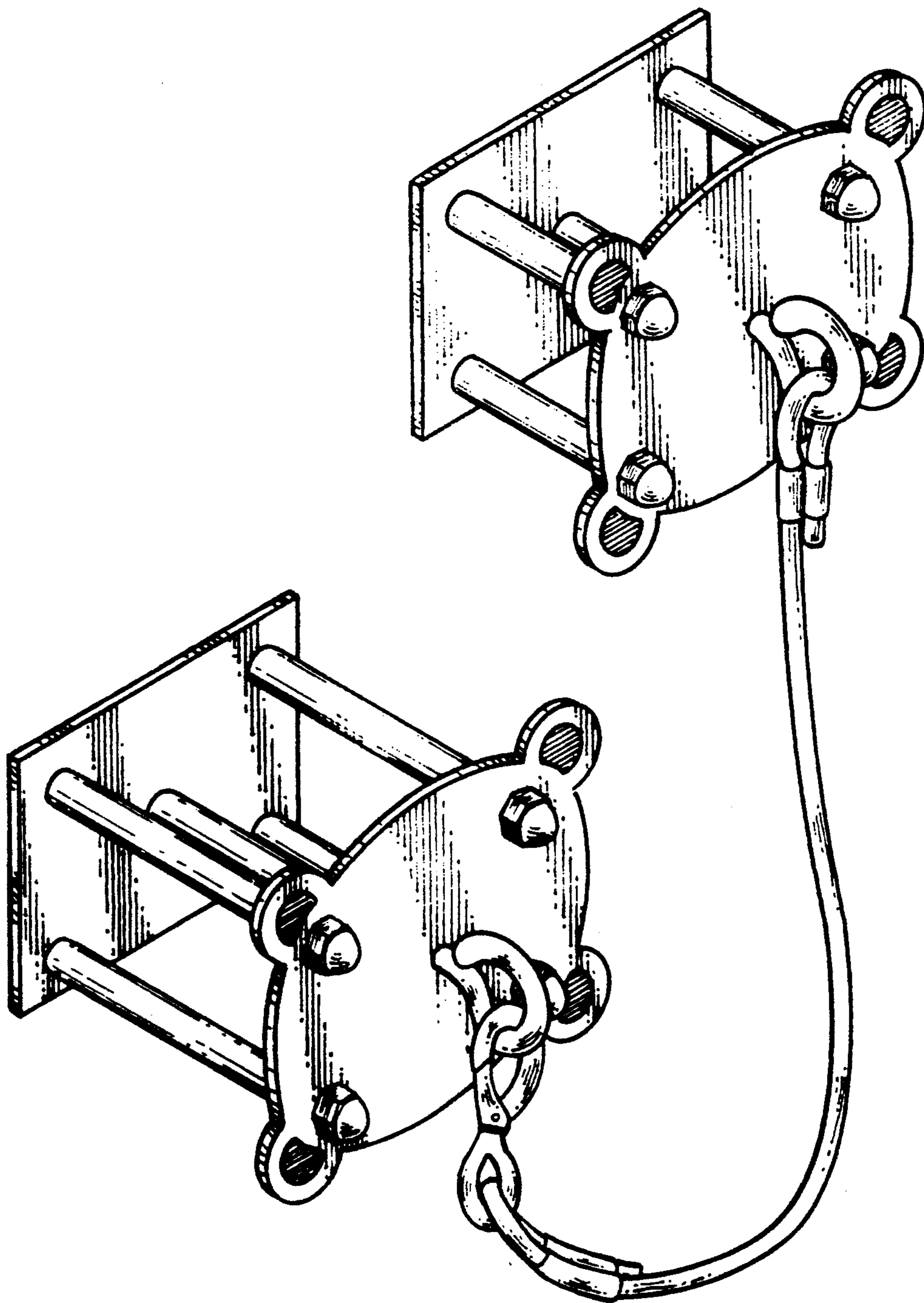

FIG. 1

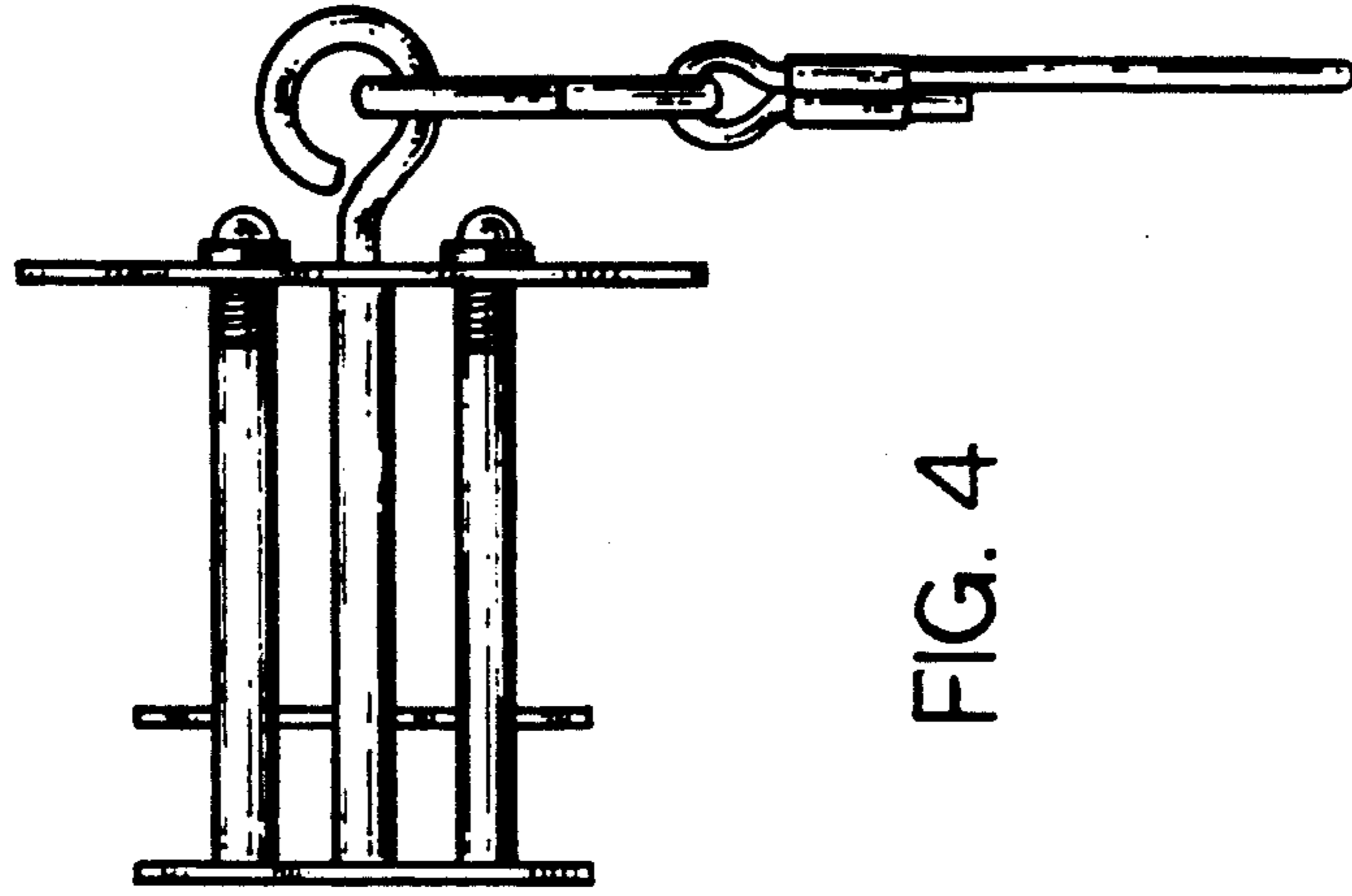

FIG. 4

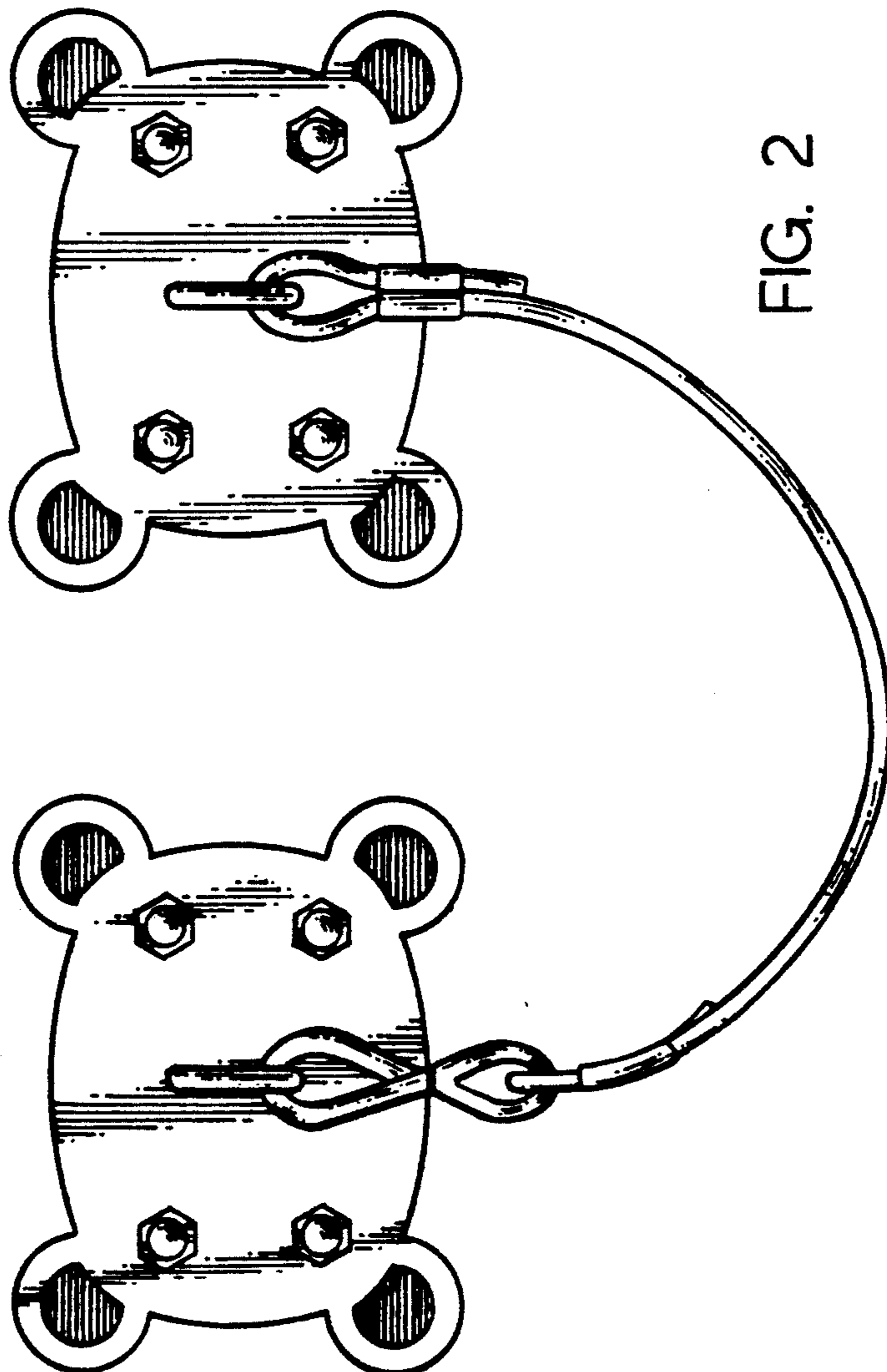

FIG. 2

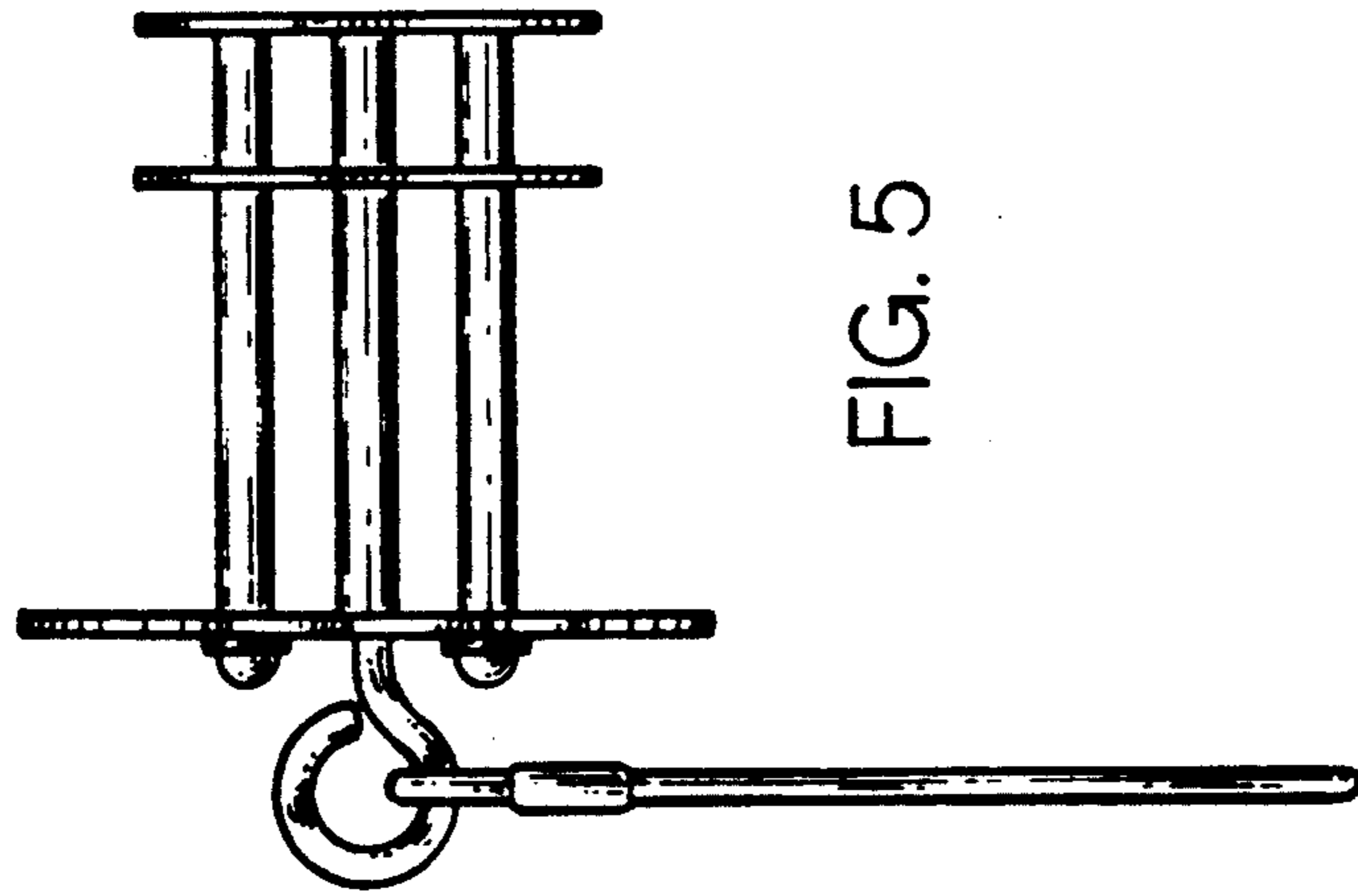

FIG. 5

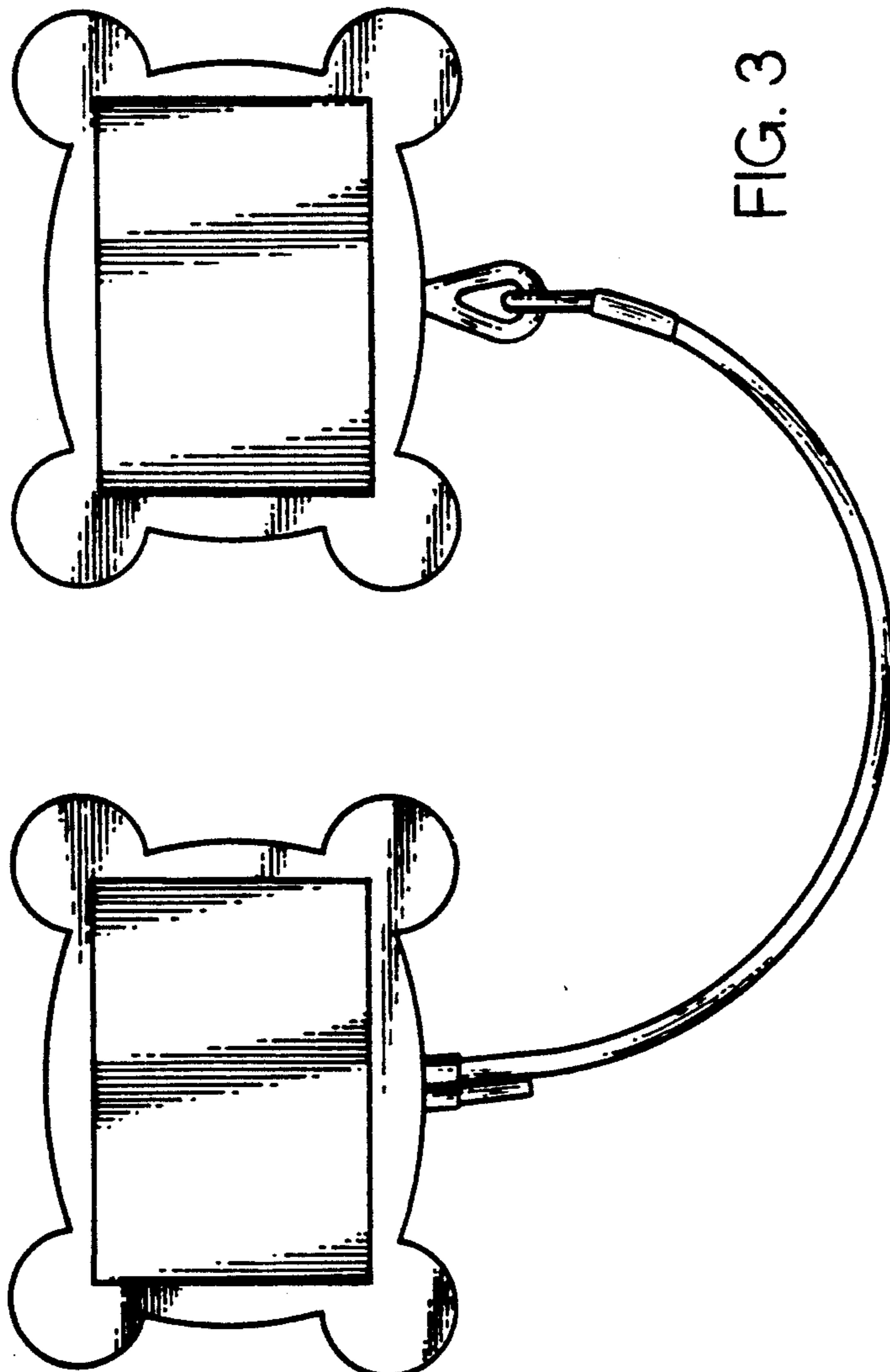

FIG. 3

FIG. 6

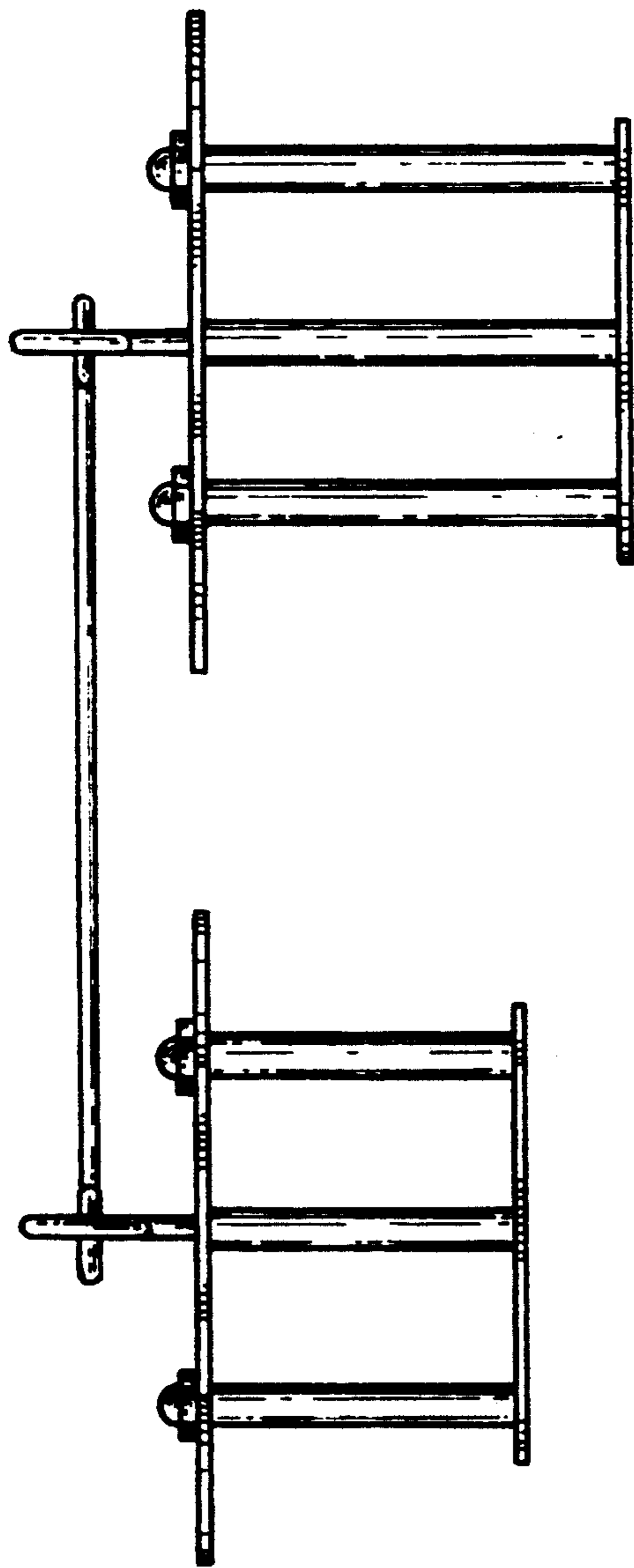

FIG. 7

