



US00D334038S

United States Patent [19]

[11] Patent Number: Des. 334,038

Case

[45] Date of Patent: ** Mar. 16, 1993

[54] BICYCLE EXERCISE STAND

4,262,899 4/1981 Alvarez 482/61

[76] Inventor: Robert A. Case, 654 N. Main St.,
Palmer, Mass. 01069

4,596,386 6/1986 Sackl 482/61

4,941,651 7/1990 Phillips 482/61

[**] Term: 14 Years

Primary Examiner—Bernard Ansher

Assistant Examiner—Philip Hyder

Attorney, Agent, or Firm—Leon Gilden

[21] Appl. No.: 619,687

[57] CLAIM

[22] Filed: Nov. 29, 1990

The ornamental design for a bicycle exercise stand, as shown and described.

[52] U.S. Cl. D21/194; D21/191

[58] Field of Search D21/191, 194; 482/61

DESCRIPTION

[56] References Cited

FIG. 1 is a front elevational view of the bicycle exercise stand showing my new design;

FIG. 2 is a rear elevational view thereof;

FIG. 3 is a left side elevational view thereof;

FIG. 4 is a right side elevational view thereof;

FIG. 5 is a top plan view thereof;

FIG. 6 is a bottom plan view thereof; and,

FIG. 7 is a perspective view thereof.

U.S. PATENT DOCUMENTS

D. 280,225	8/1985	Eagle	D21/191
D. 288,995	3/1987	Cooper	D21/191
D. 304,357	10/1989	Maes	D21/194
D. 306,193	2/1990	Blackburn	D21/191
3,107,915	10/1963	Looney	482/61
3,572,758	3/1971	Lee	482/61

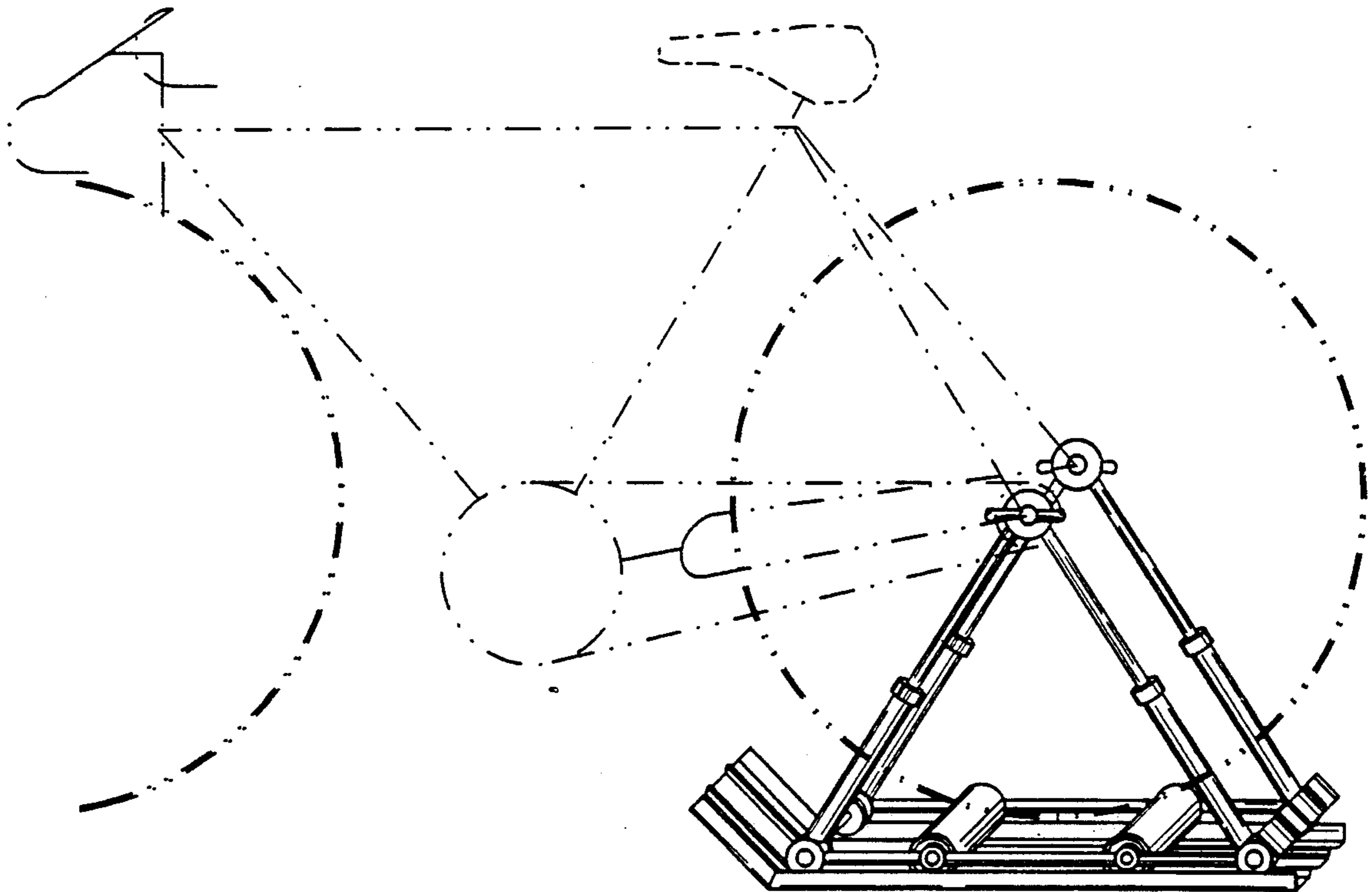

FIG. 1

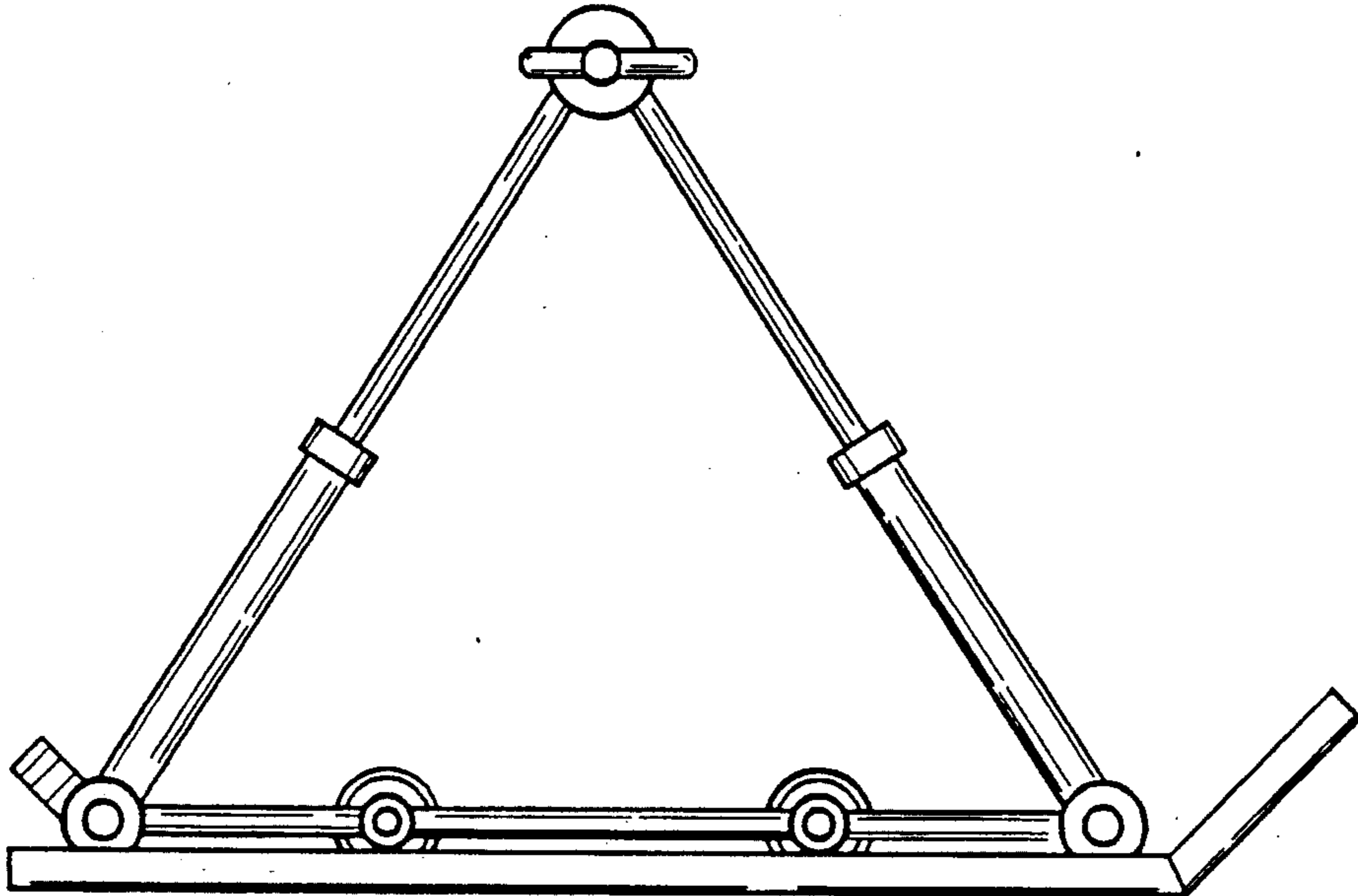

FIG. 2

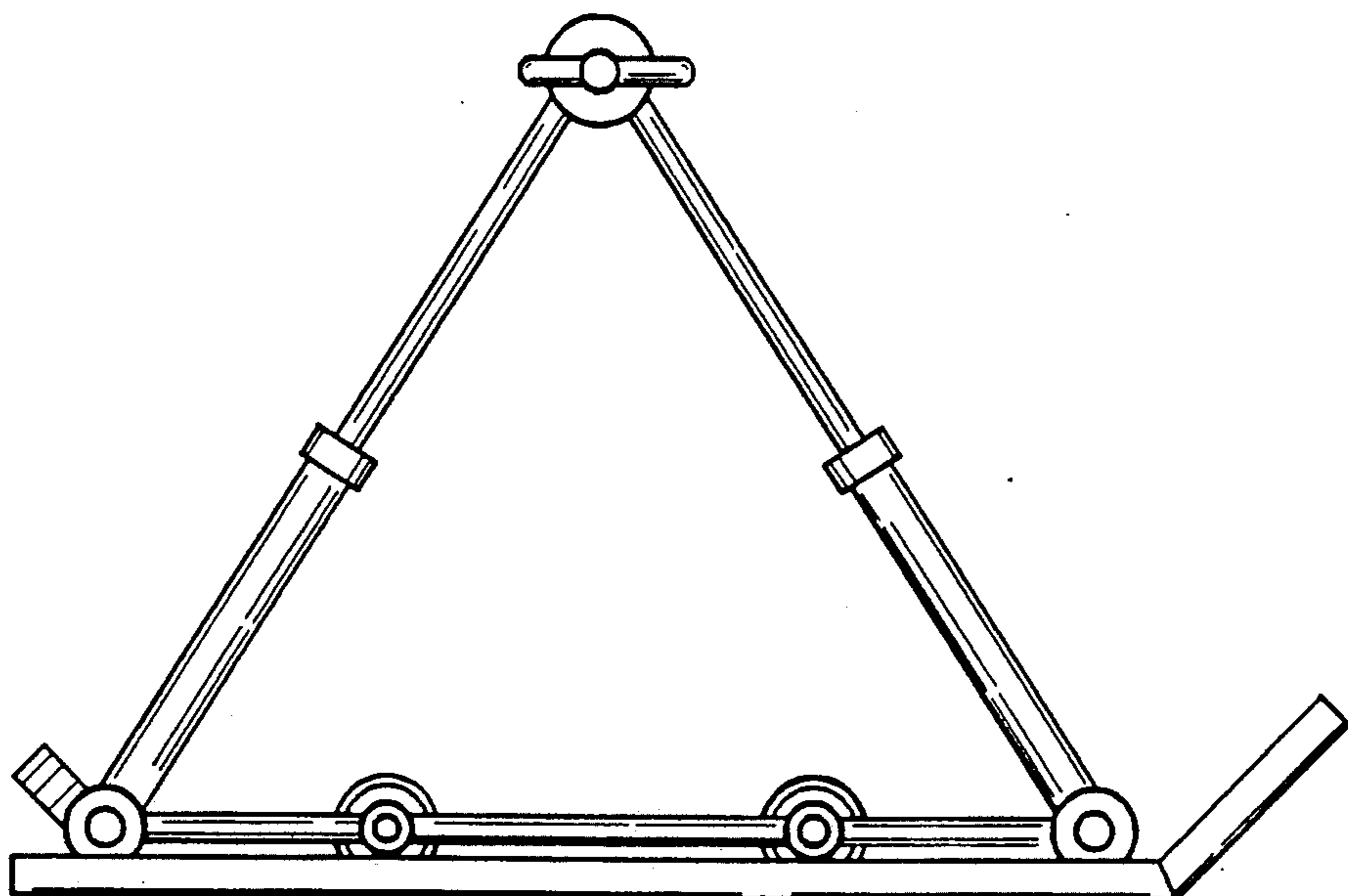

FIG. 3

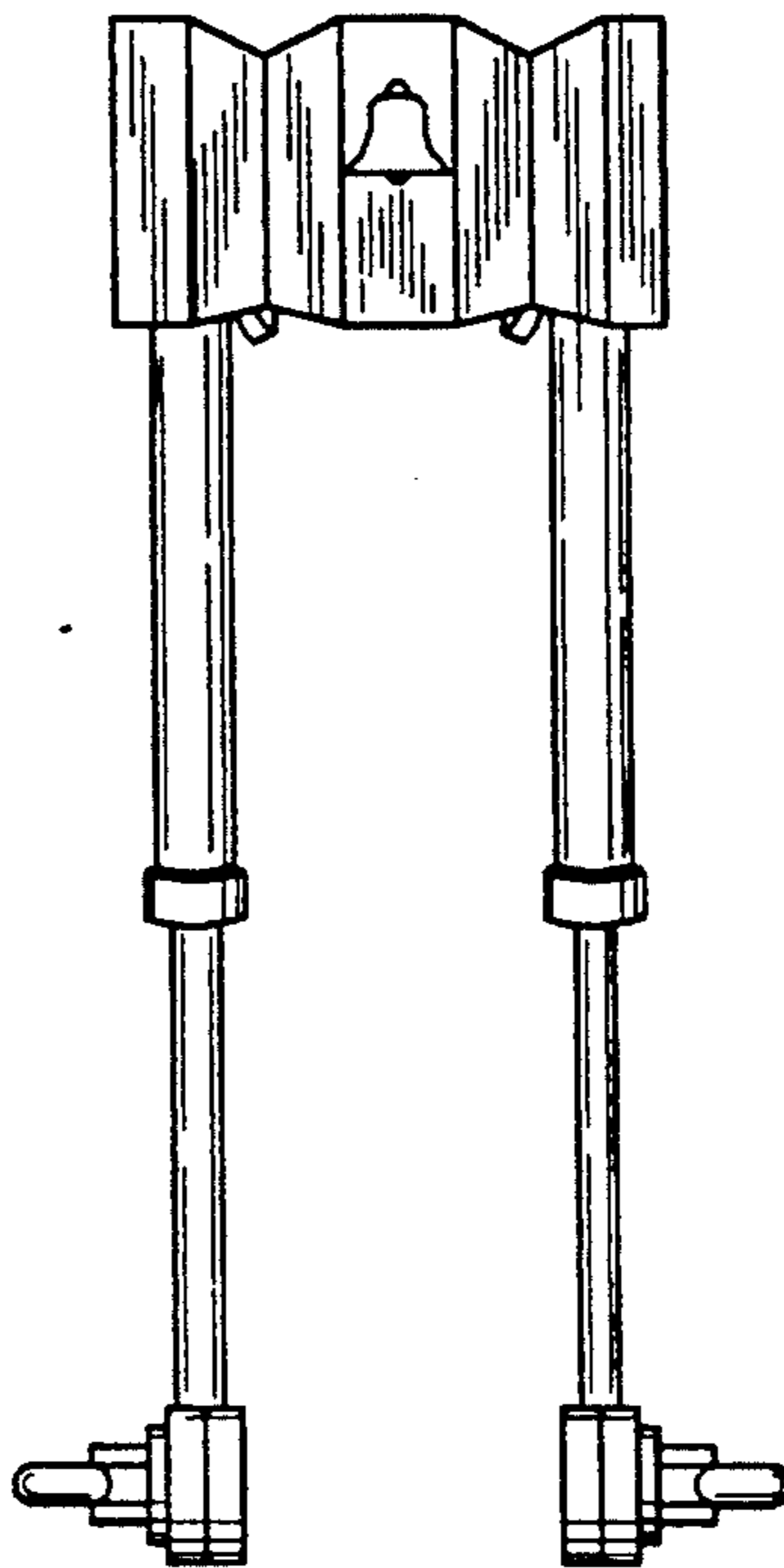

FIG. 4

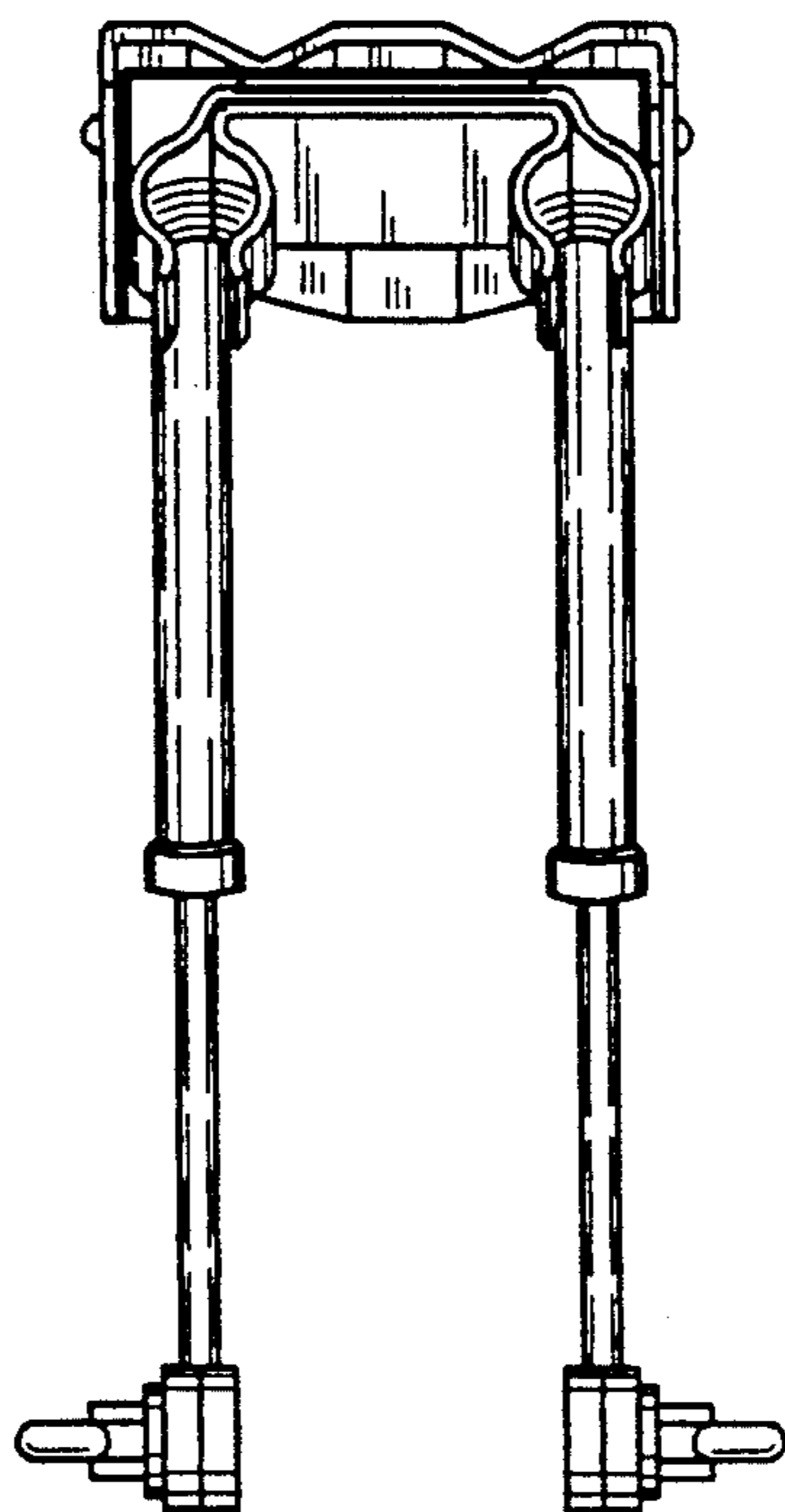

FIG. 5

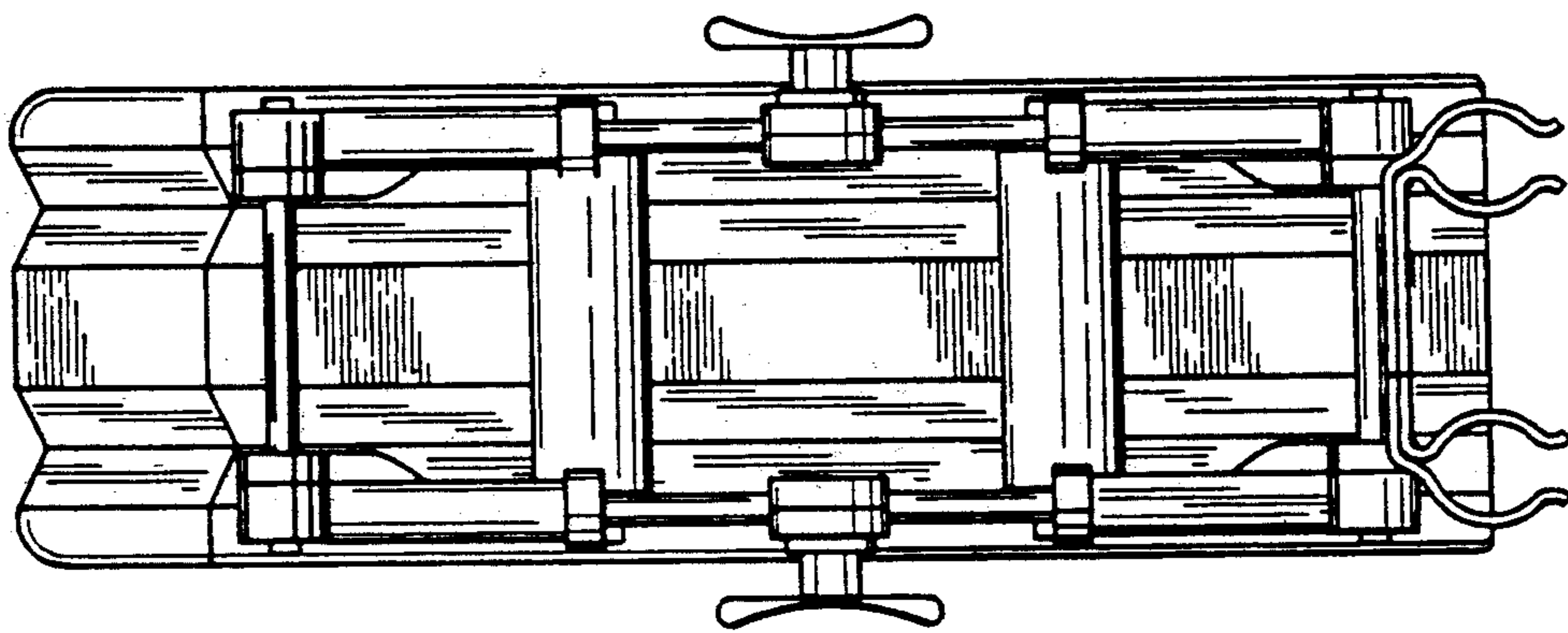

FIG. 6

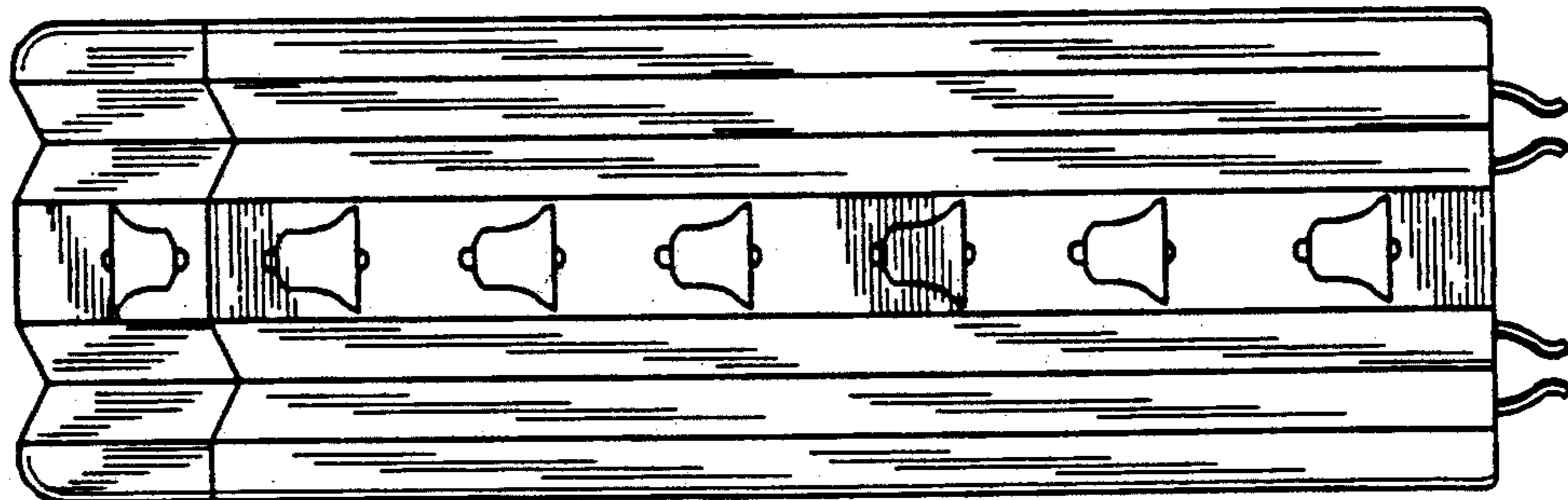

FIG. 7

