



US00D334014S

United States Patent [19]

[11] Patent Number: **Des. 334,014**

Jambhekar et al.

[45] Date of Patent: **** Mar. 16, 1993**

[54] **HOUSING FOR A PORTABLE HANDSET TELEPHONE**

[75] Inventors: **Shrirang Jambhekar, Villa Park; Rudolph Krolopp, Elk Grove, both of Ill.**

[73] Assignee: **Motorola, Inc., Schaumburg, Ill.**

[**] Term: **14 Years**

[21] Appl. No.: **710,295**

[22] Filed: **Jun. 4, 1991**

[52] U.S. Cl. **D14/138**

[58] Field of Search **D14/138, 147, 248, 148; 379/437, 61, 58, 433, 434**

[56] **References Cited**

U.S. PATENT DOCUMENTS

- D. 154,487 7/1949 Hose D14/153
- D. 276,520 11/1984 Breslow et al. 179/103
- D. 276,722 12/1984 Festa D14/143
- D. 277,574 2/1985 Lee D14/64
- D. 278,815 5/1985 Williams D14/63
- D. 279,004 5/1985 Ryan D14/63
- D. 279,005 5/1985 Genaro et al. D14/63
- D. 280,986 10/1985 Kao D14/53
- D. 281,242 11/1985 Hova D14/53
- D. 281,496 11/1985 Chen D14/53
- D. 281,686 12/1985 Rivette et al. D14/53
- D. 281,687 12/1985 Sakow D14/53
- D. 282,465 2/1986 Hurley et al. D14/53
- D. 282,544 2/1986 Wu D14/53
- D. 282,738 2/1986 Nichols D14/53
- D. 282,743 2/1986 Huang D14/53
- D. 283,126 3/1986 Marshall D14/53
- D. 284,468 7/1986 Matras D14/53
- D. 284,759 7/1986 Nagele et al. D14/53
- D. 284,761 7/1986 Ryan D14/53
- D. 286,778 11/1986 Beaumont D14/64
- D. 287,488 12/1986 Brignole D14/143

- D. 290,004 5/1987 Kao D14/143
- D. 301,464 6/1989 Yoshiharu D14/143 X
- D. 305,427 1/1990 Soren et al. D14/138
- D. 318,052 7/1991 Garza D14/143
- D. 318,275 7/1991 Benjelloun D14/143 X
- D. 321,186 10/1991 Blinn D14/143
- 4,018,998 4/1977 Wegner 179/103
- 4,936,037 6/1990 Holcomb et al. 379/440
- 4,969,180 11/1990 Watterson 379/434

FOREIGN PATENT DOCUMENTS

- 1143203 8/1957 France D14/143
- 135959 8/1984 Japan .
- 2070392 9/1981 United Kingdom .

OTHER PUBLICATIONS

Realistic Duofone Owners Manual ET-415, Cat. No. 43-555 Cordless Electric Telephone. Matsushita Cordless Telephone FCC Grant of Equipment Authorization: Jul. 31, 1987; Exhibit E (FCC Identifier ACJ96NKX T3000).

Primary Examiner—Susan J. Lucas
Attorney, Agent, or Firm—Darleen J. Stockley

[57] **CLAIM**

The ornamental design for a housing for a portable handset telephone, as shown and described.

DESCRIPTION

FIG. 1 is a front elevational view of a housing for a portable handset telephone showing our new design; FIG. 2 is a rear elevational view thereof; FIG. 3 is a left elevational view thereof; FIG. 4 is a right elevational view thereof; FIG. 5 is a top plan view thereof; FIG. 6 is a bottom plan view thereof; and, FIG. 7 is a vertical cross-section of FIG. 1. Broken line matter showing in FIGS. 1, 2, 4, and 6 is used for illustrative purposes only and forms no part of the claimed design.

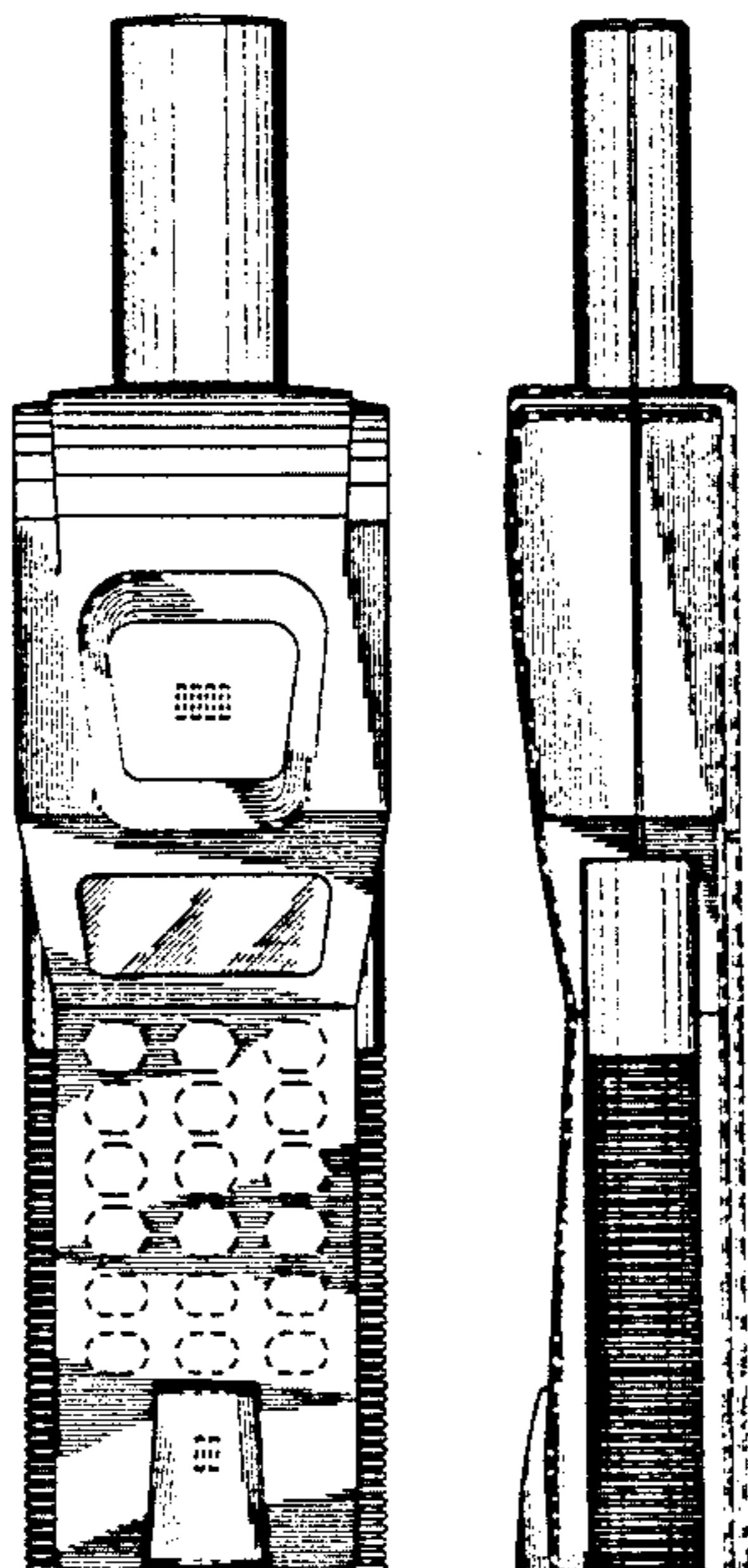

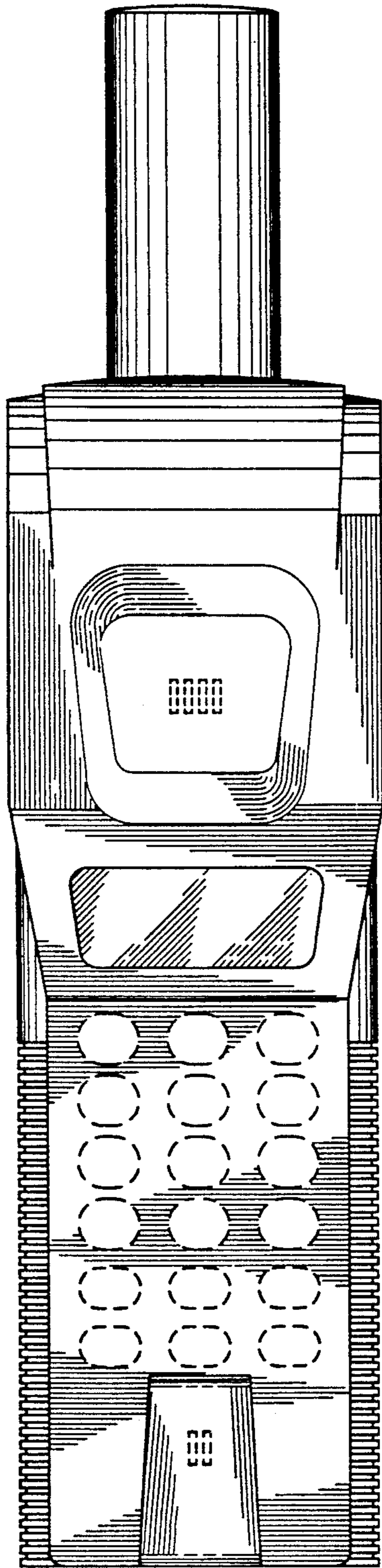

FIG. 1

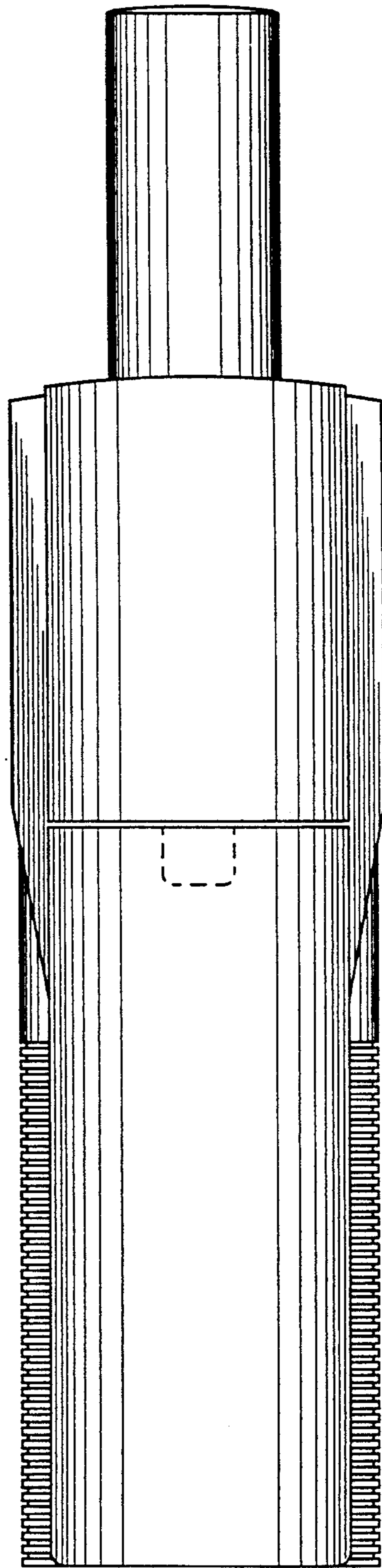

FIG. 2

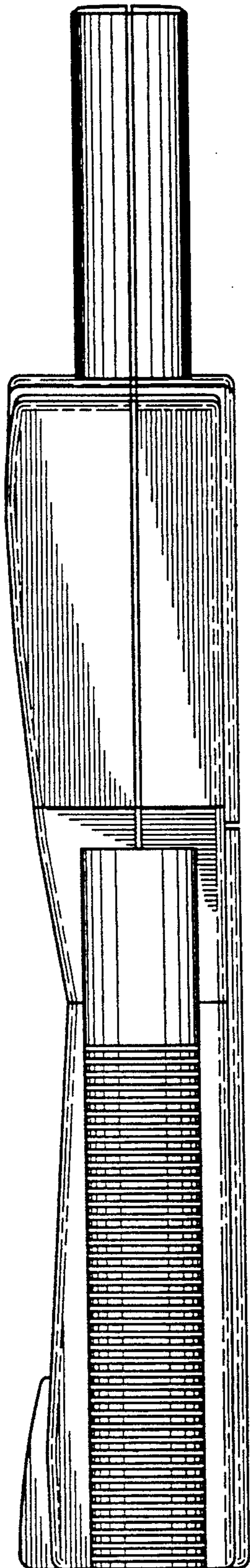
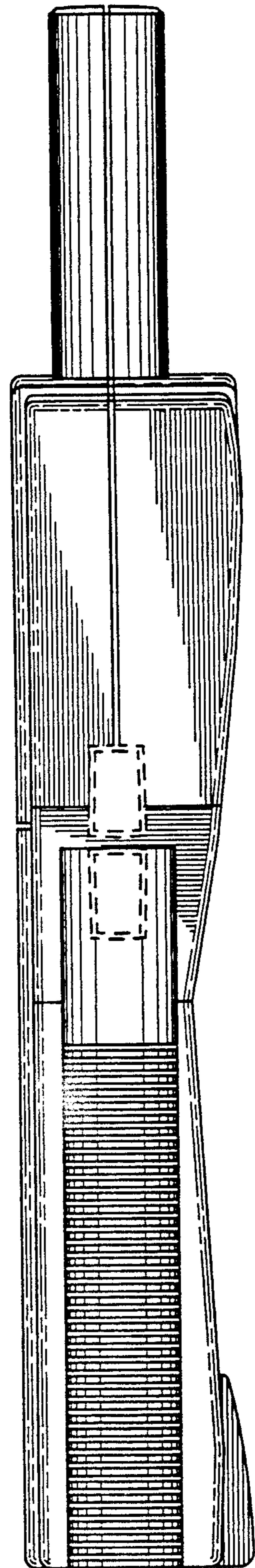

FIG. 3

FIG. 4



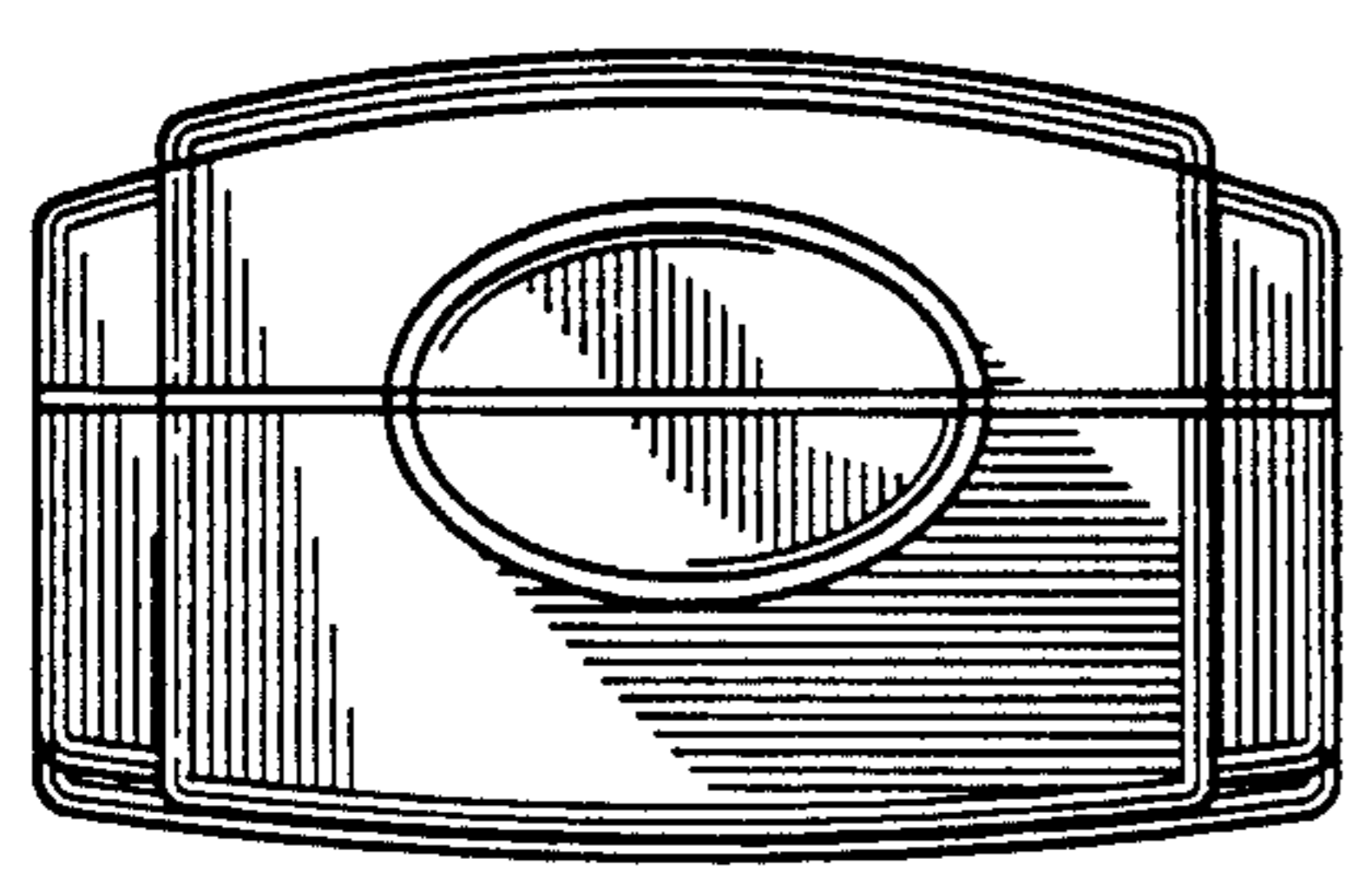

FIG. 5

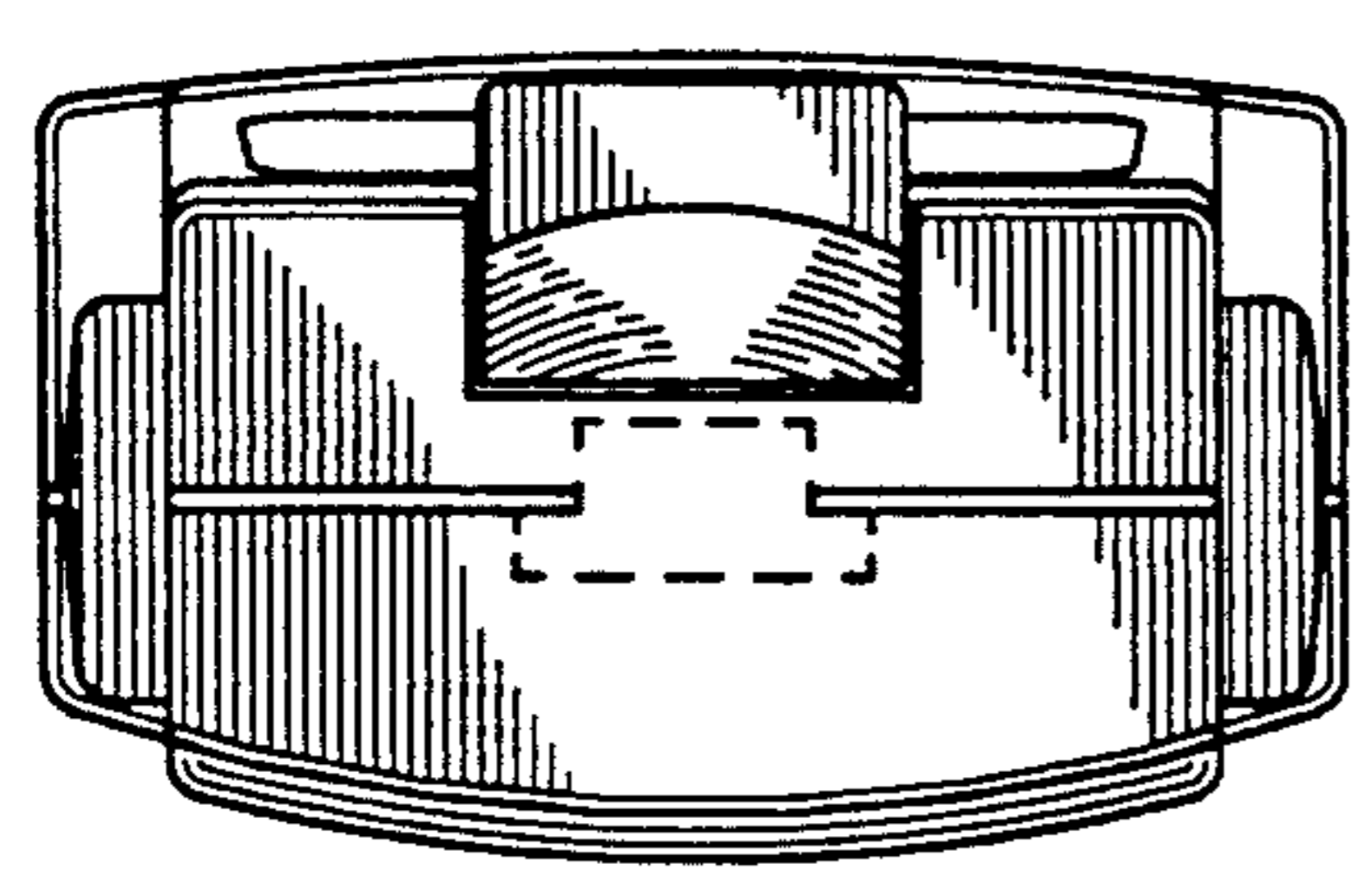

FIG. 6

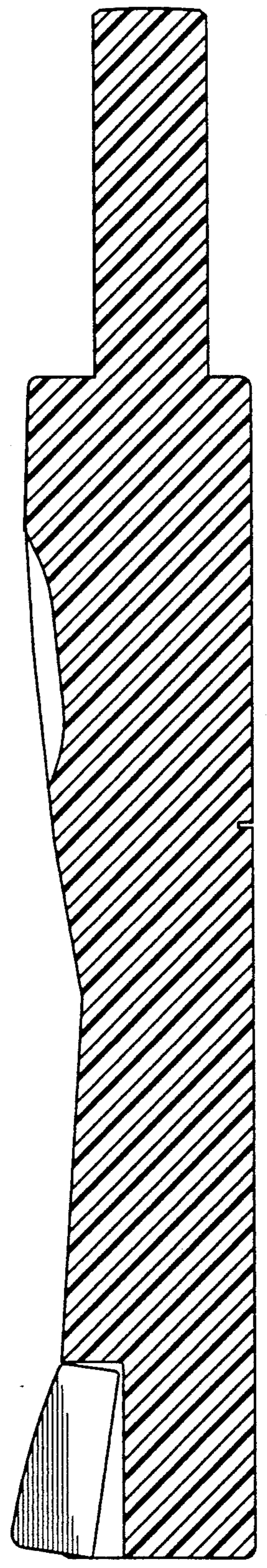

FIG. 7