



US00D333958S

United States Patent [19]

[11] Patent Number: Des. 333,958

Demers

[45] Date of Patent: ** Mar. 16, 1993

[54] JAR OPENER

[76] Inventor: Serge Demers, P.O. Box 166, St. Basile, New Brunswick, Canada, EOL7170

[**] Term: 14 Years

[21] Appl. No.: 760,249

[22] Filed: Sep. 16, 1991

[52] U.S. Cl. D8/40

[58] Field of Search D8/18, 33-37, D8/39-43; D11/79; D3/62, 64; 81/3.4, 3.44, 3.07, 3.09, 3.2, 3.25, 3.33, 3.35, 3.45, 3.47, 3.48, 3.55, 3.57; 7/152, 156

[56] **References Cited**

U.S. PATENT DOCUMENTS

- D. 164,459 9/1951 Stolpe D8/37
- D. 258,192 2/1981 Maloney D8/37

- D. 267,624 1/1983 Funka D8/37
- D. 277,925 3/1985 Blackburn D8/37
- D. 296,293 6/1988 Wheeler D8/43
- 1,707,804 2/1929 Haase D8/37
- 4,085,632 4/1979 Hogan D8/37

Primary Examiner—Bernard Ansher
Assistant Examiner—R. Barkai

[57] **CLAIM**

The ornamental design for a jar opener, as shown and described.

DESCRIPTION

FIG. 1 is a front elevational view of the jar opener showing my new design;
FIG. 2 is a rear elevational view thereof;
FIG. 3 is a left side elevational view thereof;
FIG. 4 is a right side elevational view thereof;
FIG. 5 is a top plan view thereof;
FIG. 6 is a bottom plan view thereof; and,
FIG. 7 is an isometric view thereof.

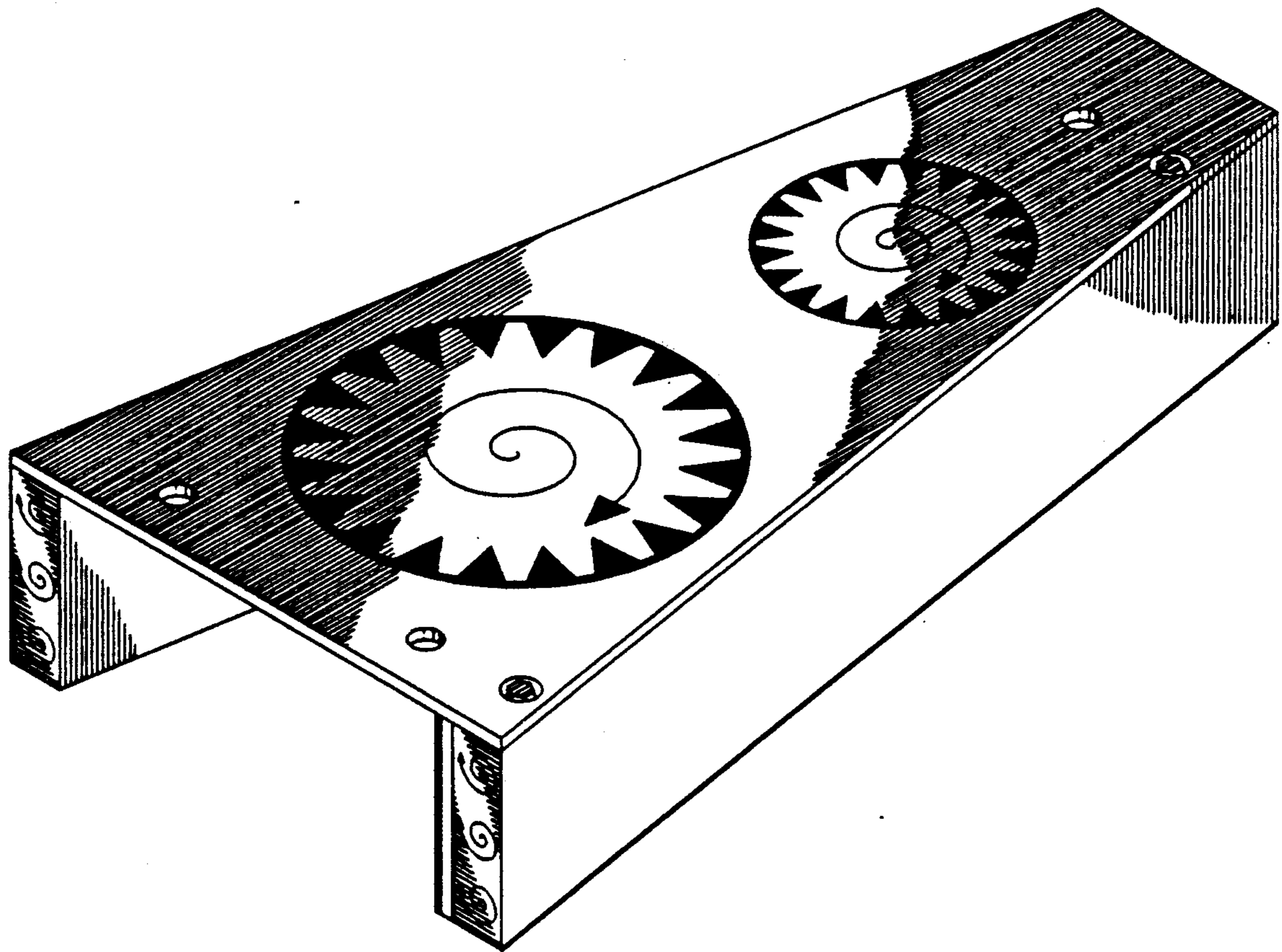

FIG. 1

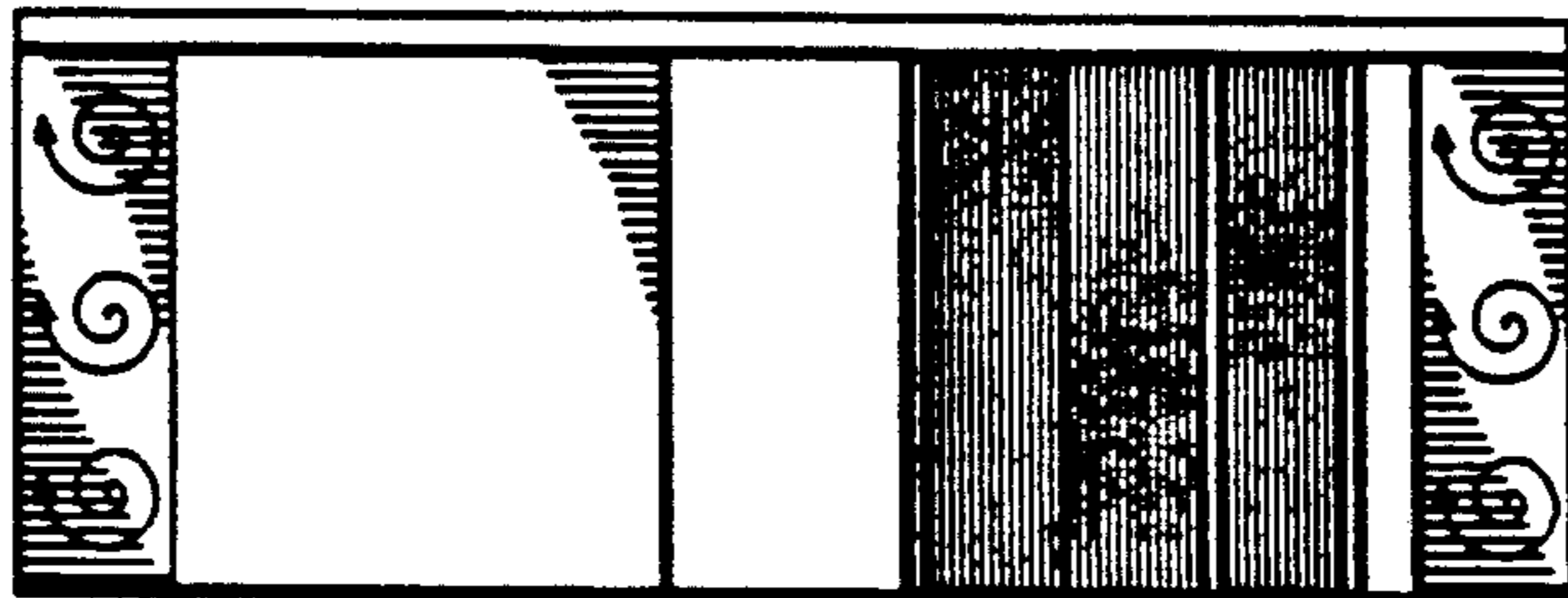

FIG. 2

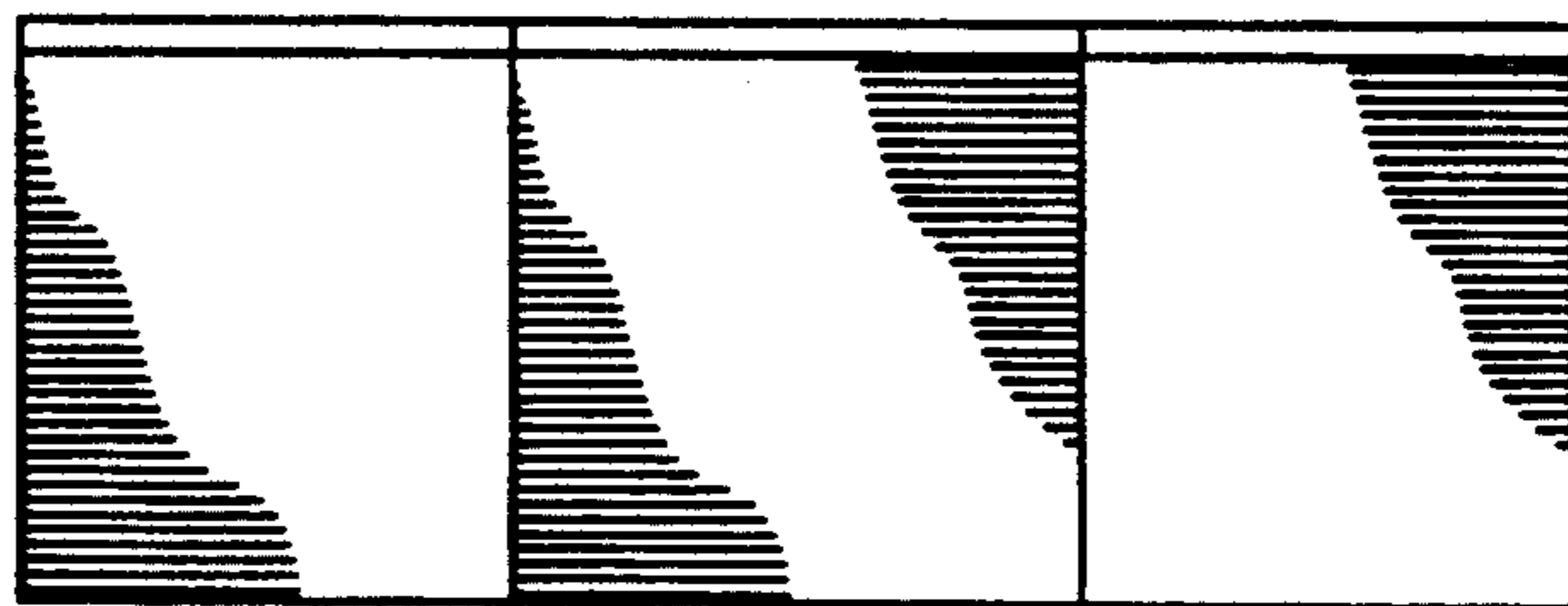

FIG. 3

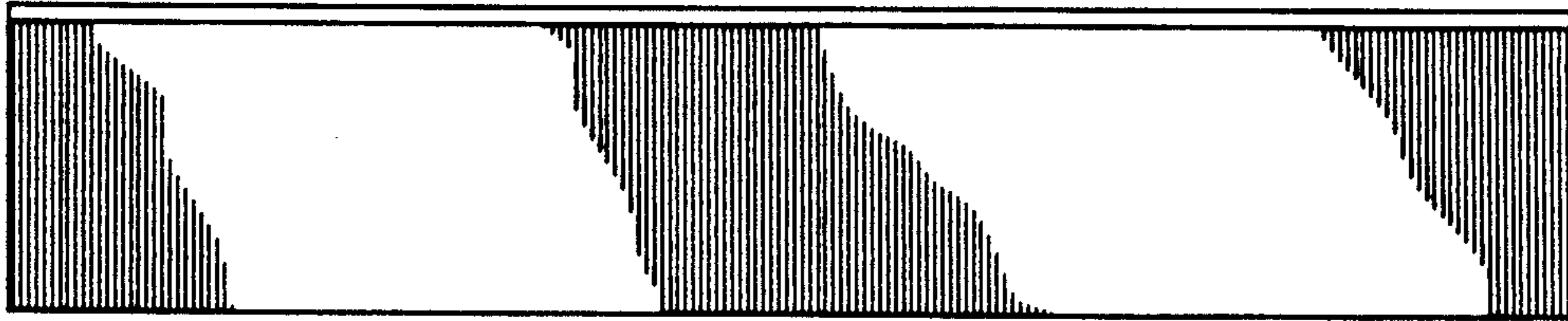

FIG. 4

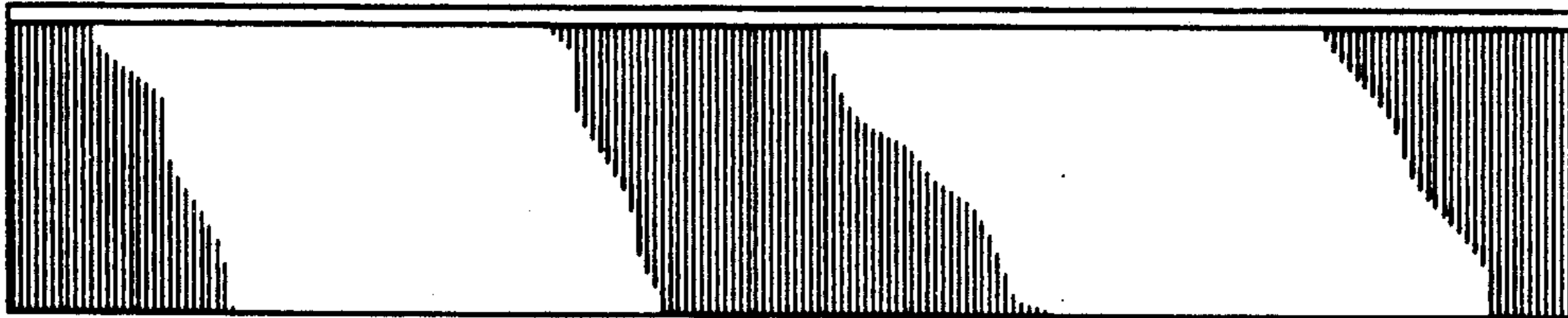

FIG. 5

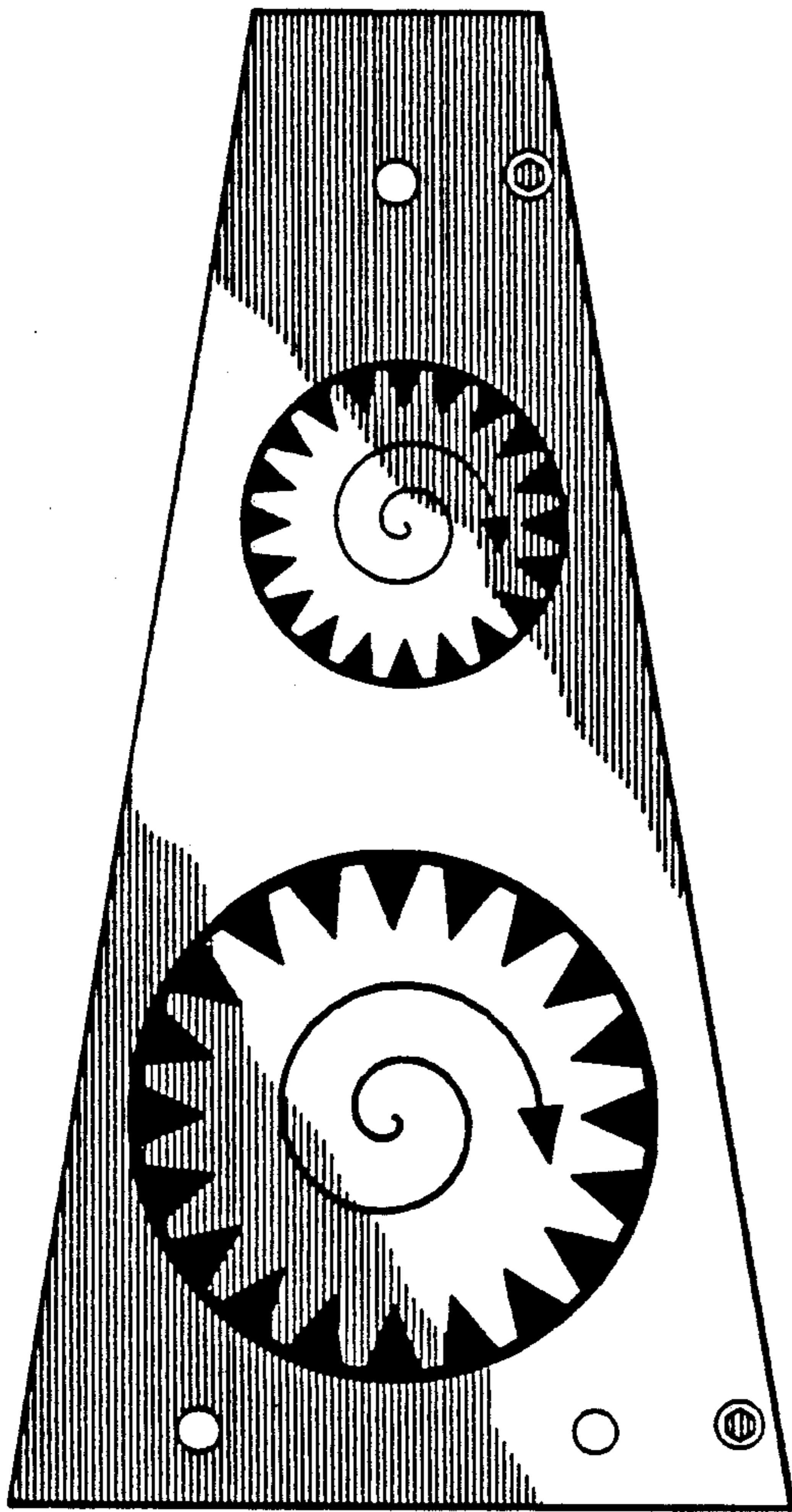

FIG. 6

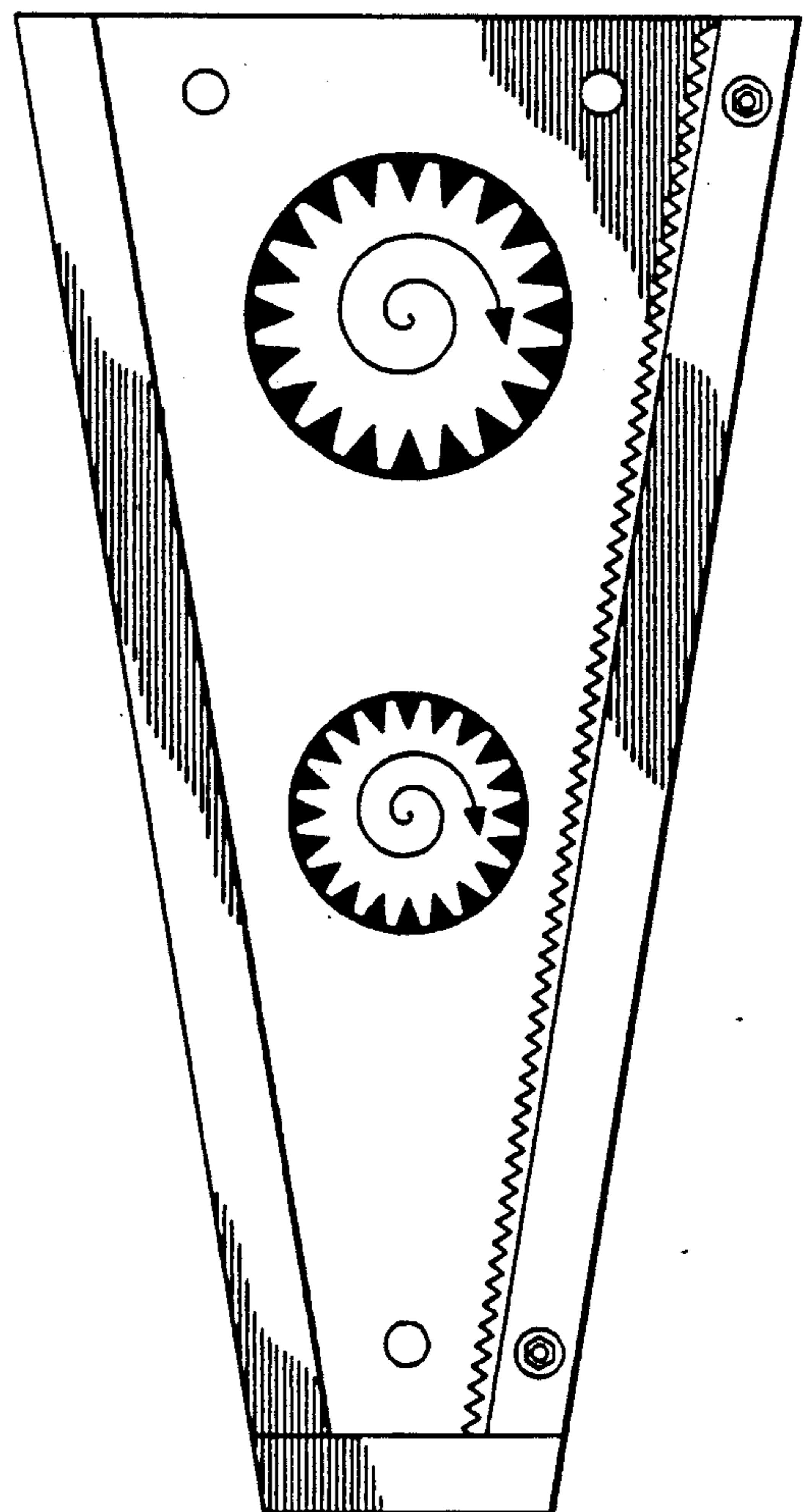

FIG. 7

