



US00D333898S

United States Patent [19]

[11] Patent Number: **Des. 333,898**

Schulze et al.

[45] Date of Patent: **** Mar. 9, 1993**

[54] WASTE CONTAINER

[57] CLAIM

[75] Inventors: **Curt J. Schulze, Lakeland, Fla.;**
James M. Nichols, Old Saybrook,
Conn.

The ornamental design for a waste container, as shown and described.

[73] Assignee: **Browning-Ferris Industries Inc.,**
Houston, Tex.

DESCRIPTION

[**] Term: **14 Years**

FIG. 1 is a top and front perspective view of a waste container showing our new design;
FIG. 2 is a top plan view thereof;
FIG. 3 is a front elevational view thereof;
FIG. 4 is a right side elevational view thereof;
FIG. 5 is a bottom plan view thereof;
FIG. 6 is a rear elevational view thereof;
FIG. 7 is a left side elevational view thereof;
FIG. 8 is a top and front perspective view of a second embodiment of the waste container;
FIG. 9 is a top plan view of FIG. 8;
FIG. 10 is a front elevational view of FIG. 8;
FIG. 11 is a right side elevational view of FIG. 8;
FIG. 12 is a bottom plan view of FIG. 8;
FIG. 13 is a rear elevational view of FIG. 8;
FIG. 14 is a left side elevational view of FIG. 8;
FIG. 15 is a top and front elevational view of a third embodiment of the waste container;
FIG. 16 is a top plan view of FIG. 15;
FIG. 17 is a front elevational view of FIG. 15;
FIG. 18 is a right side elevational view of FIG. 15;
FIG. 19 is a bottom plan view of FIG. 15;
FIG. 20 is a rear elevational view of FIG. 15; and,
FIG. 21 is a left side elevational view of FIG. 15.

[21] Appl. No.: **735,478**

[22] Filed: **Jul. 25, 1991**

[52] U.S. Cl. **D34/7; D34/5**

[58] Field of Search **D34/1-11;**
220/373, 908, 909, DIG. 16; 206/386

[56] **References Cited**

U.S. PATENT DOCUMENTS

3,434,625 3/1969 Embry, Jr. 220/908
5,111,938 5/1992 Soprano et al. 206/386

Primary Examiner—**Kay H. Chin**
Attorney, Agent, or Firm—**Robert R. Jackson**

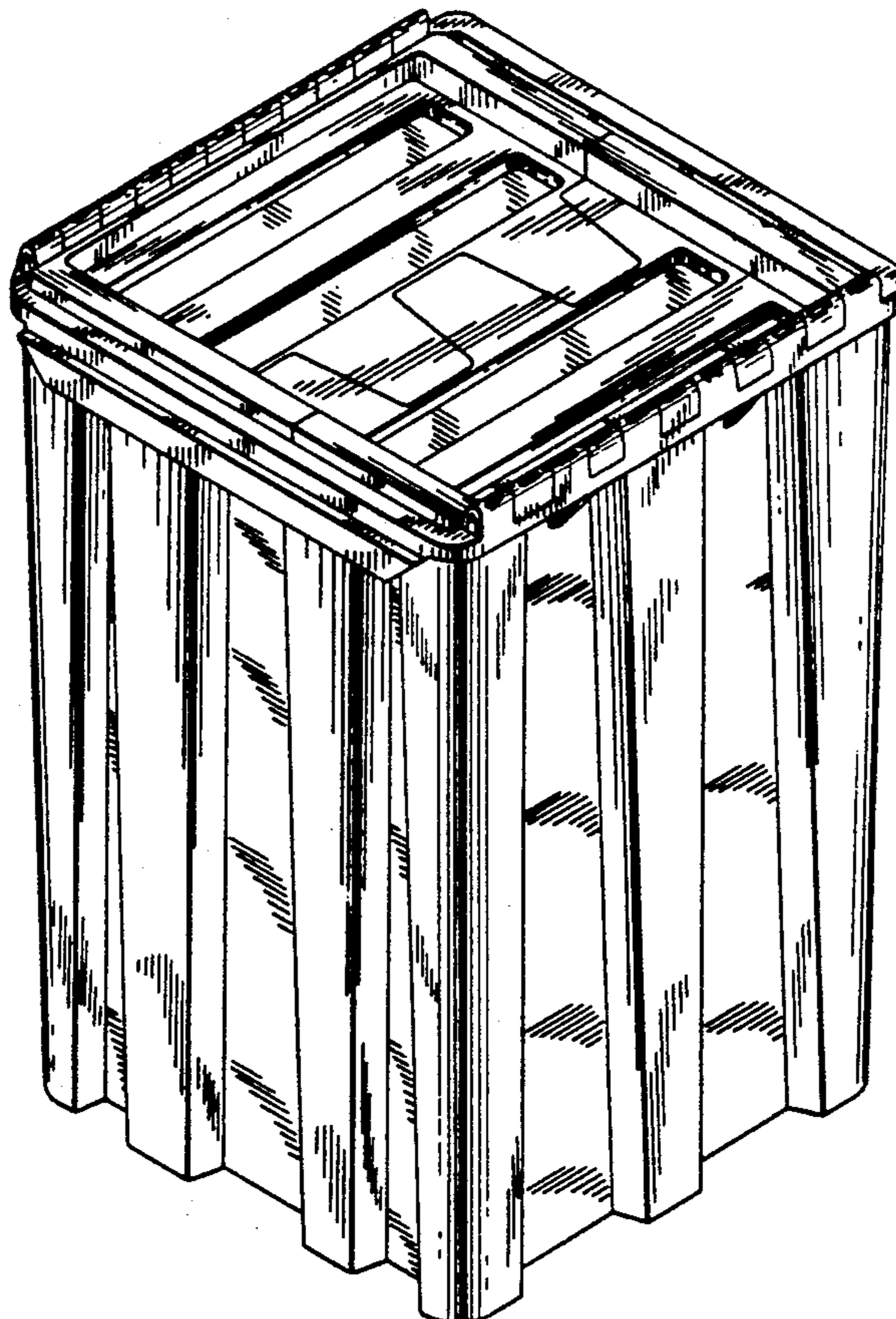

FIG. 1

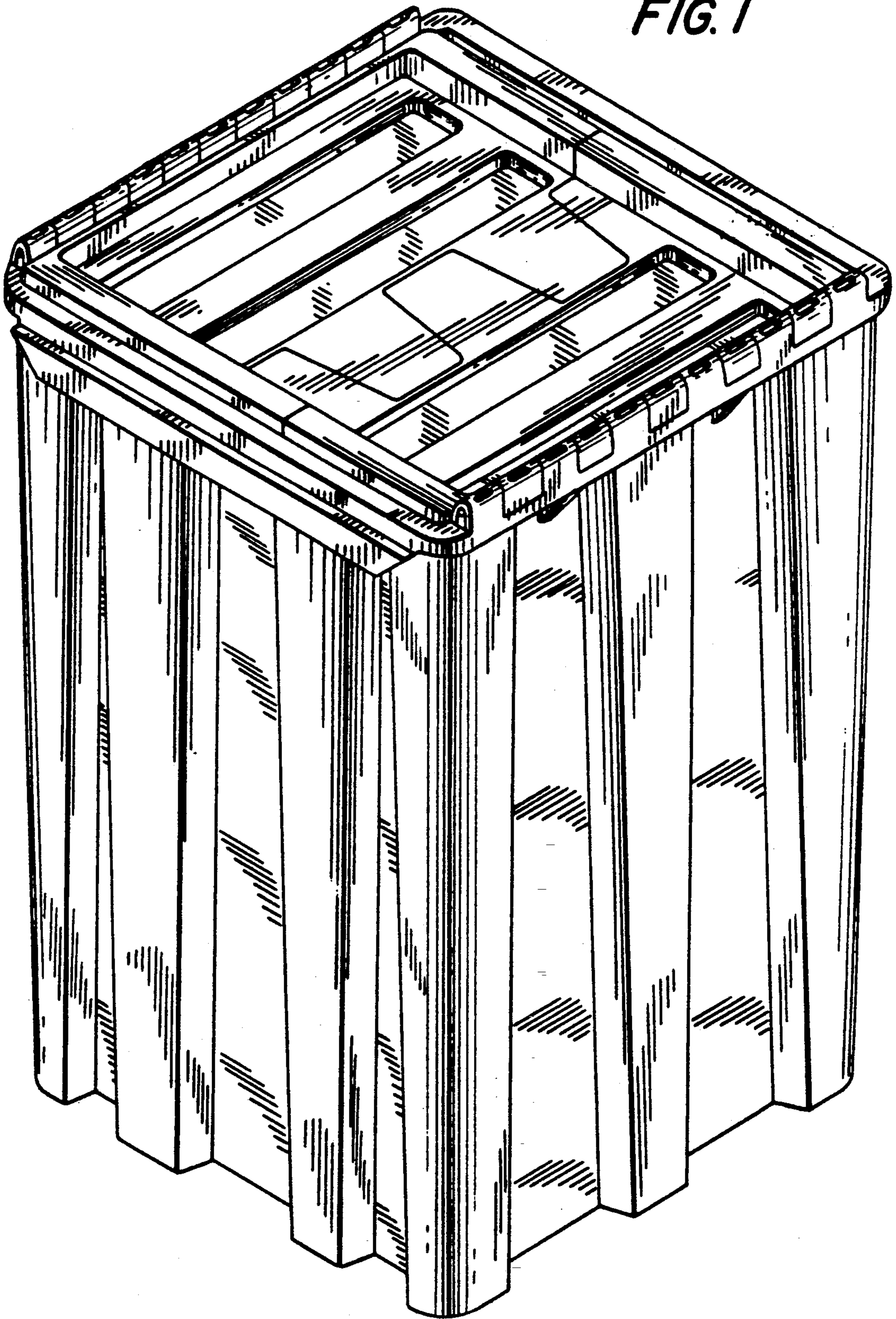

FIG. 2

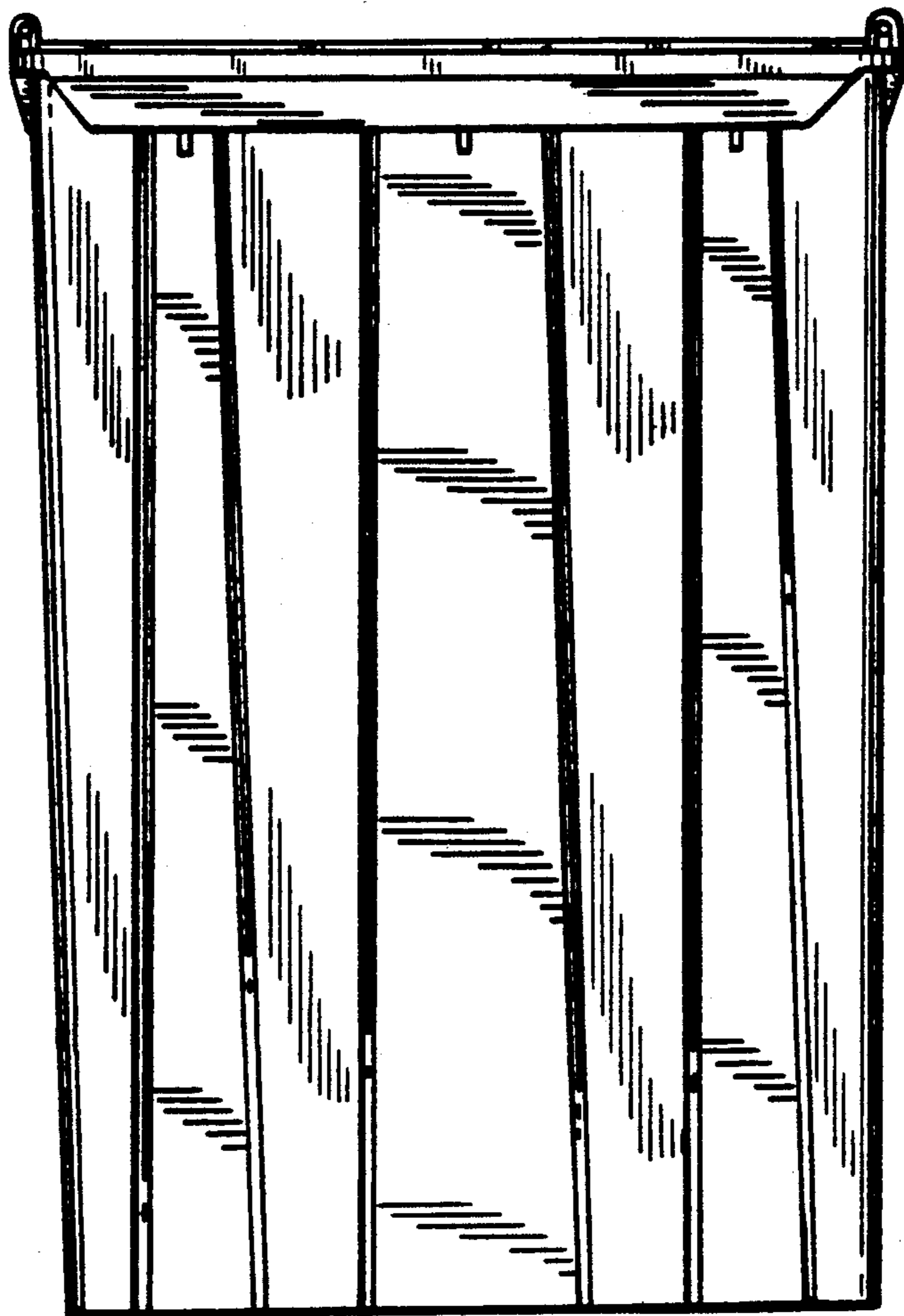
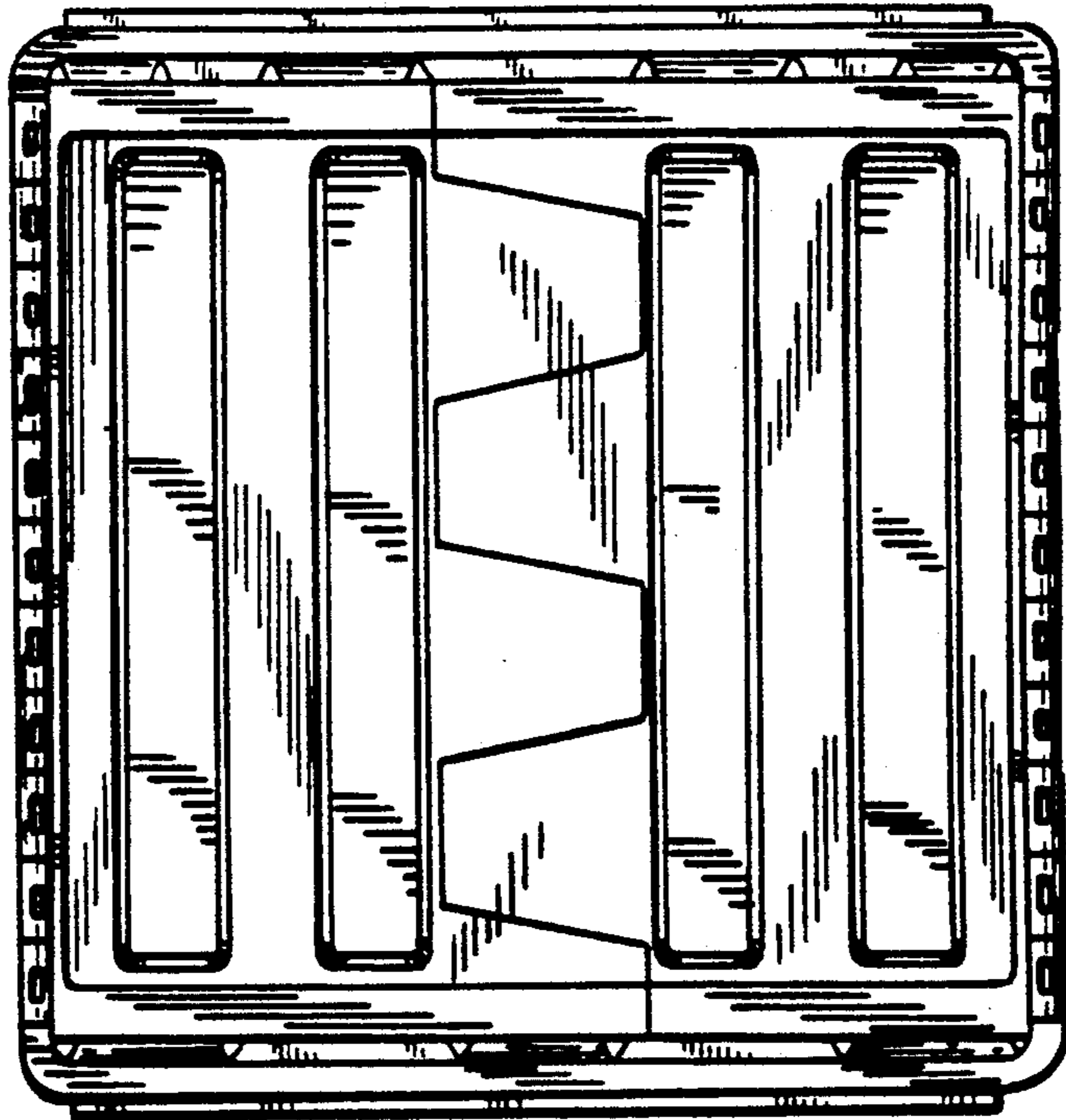

FIG. 3

FIG. 4

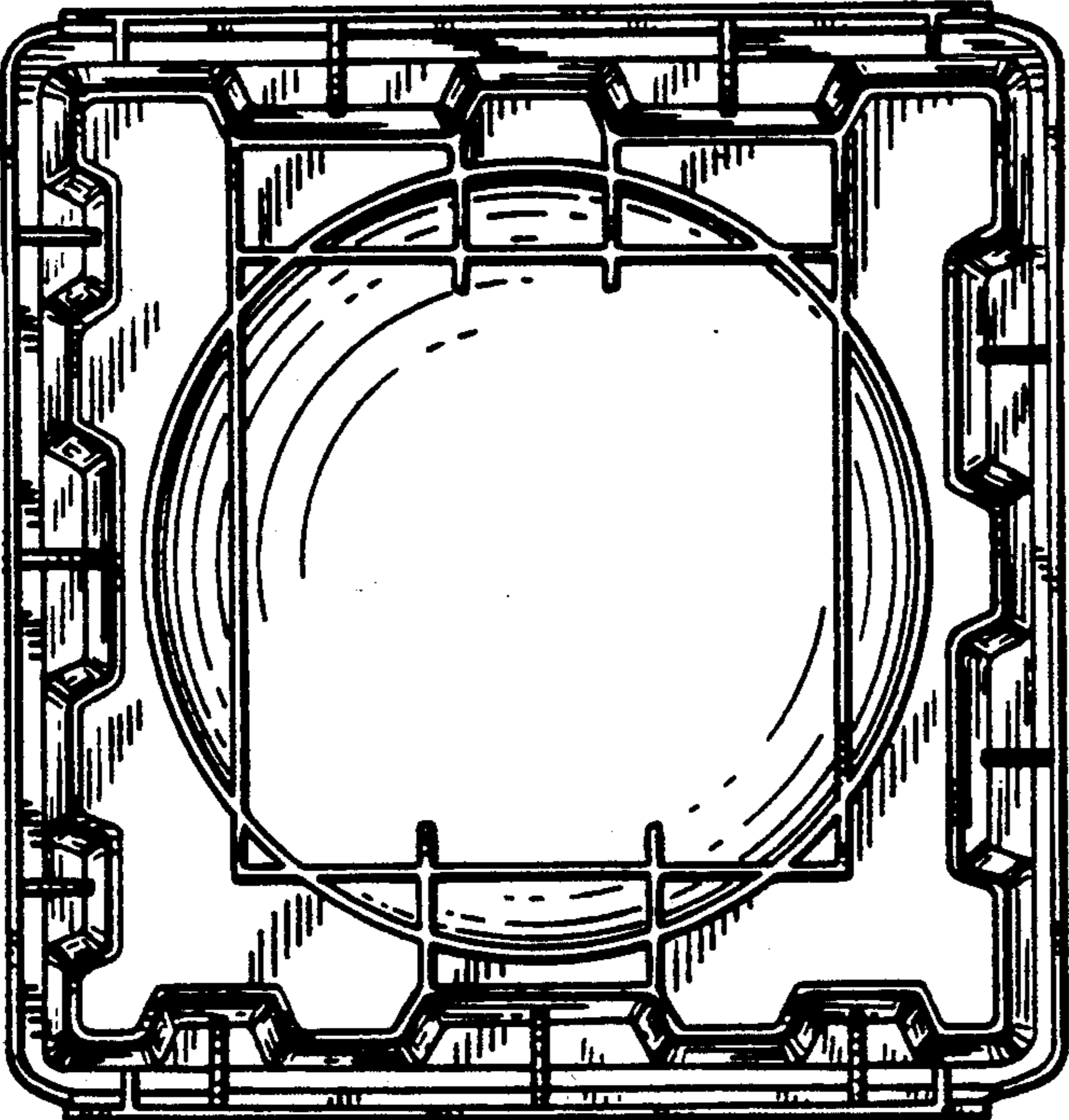
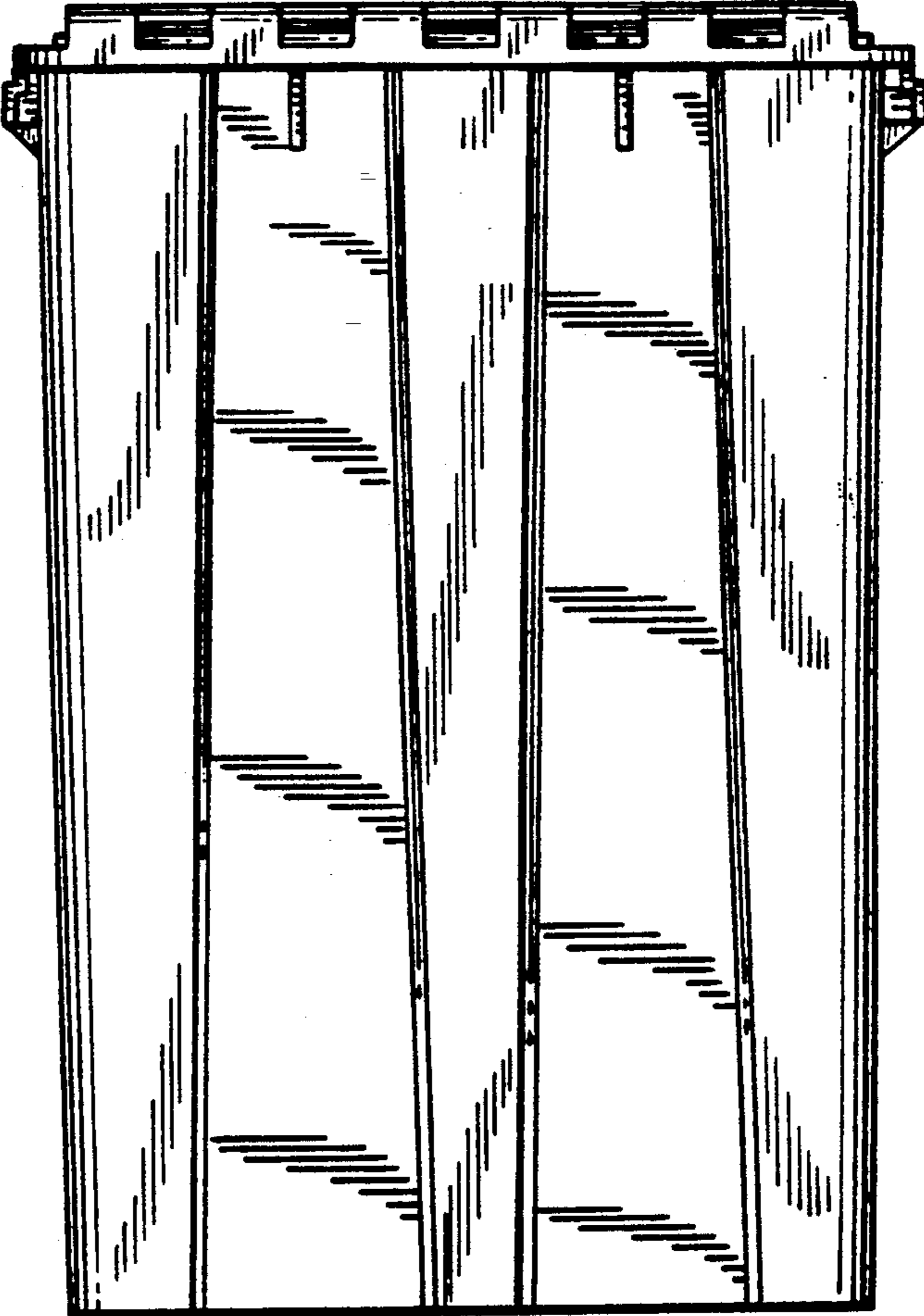

FIG. 5

FIG. 7

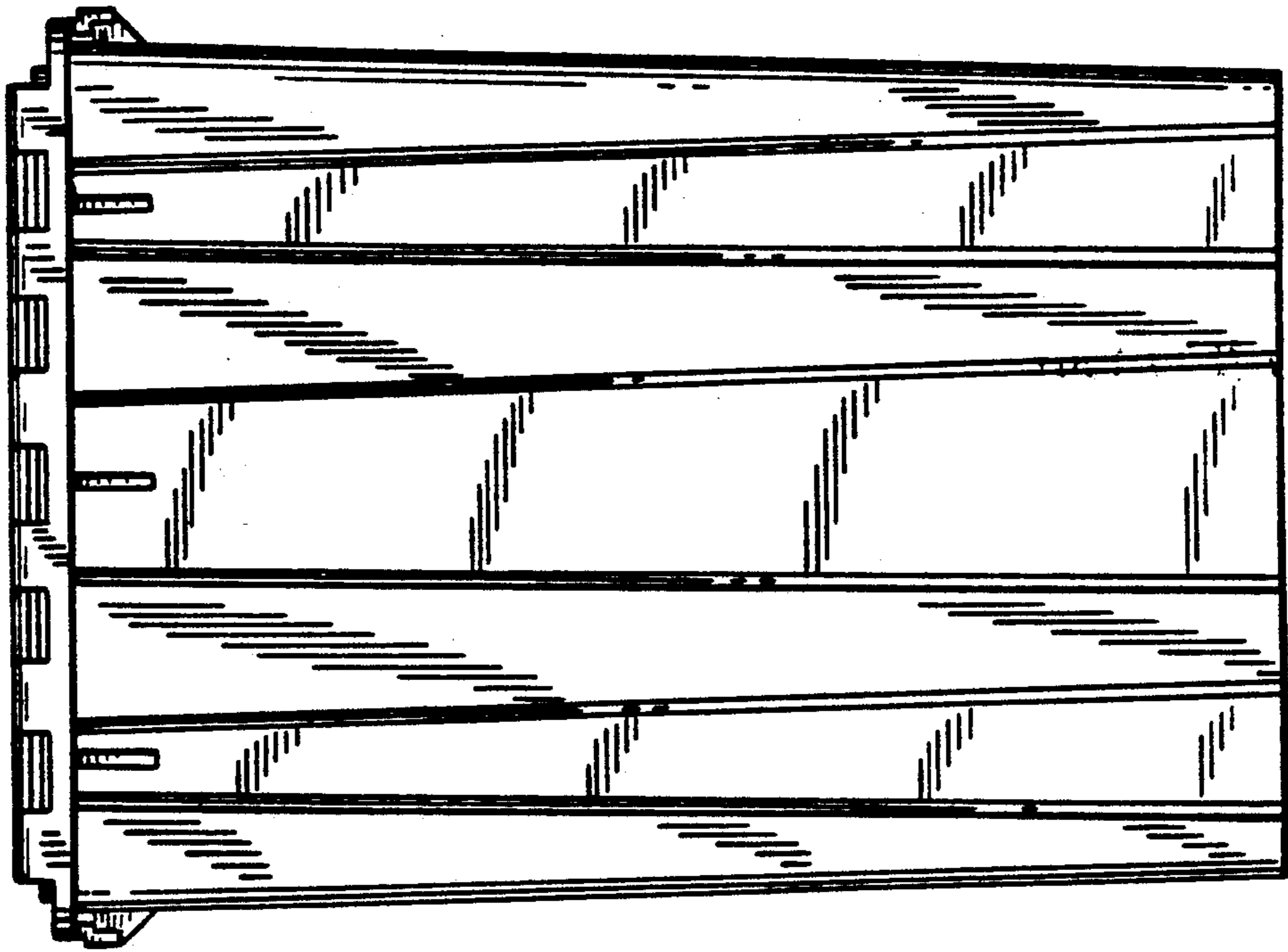

FIG. 6

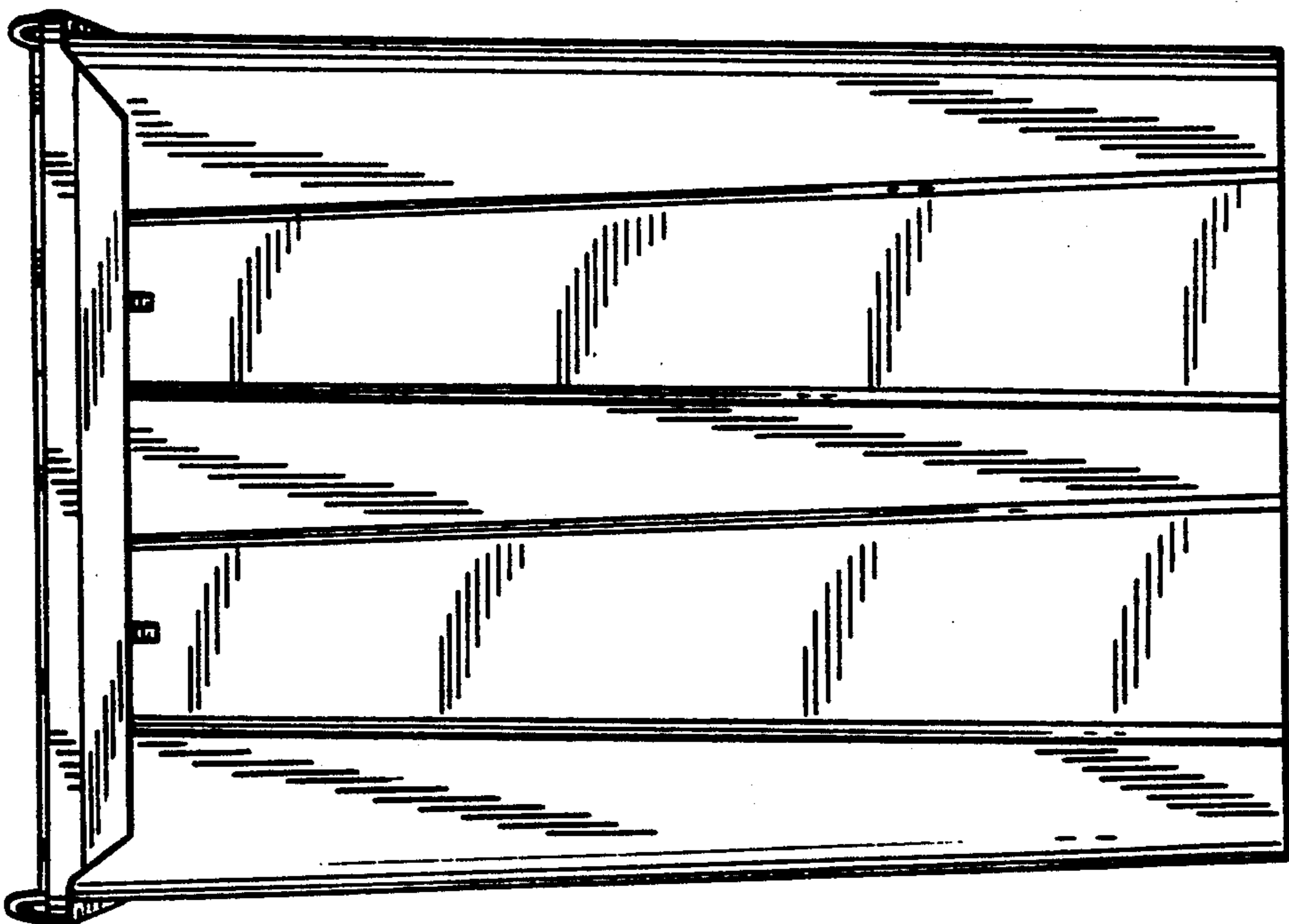

FIG. 8

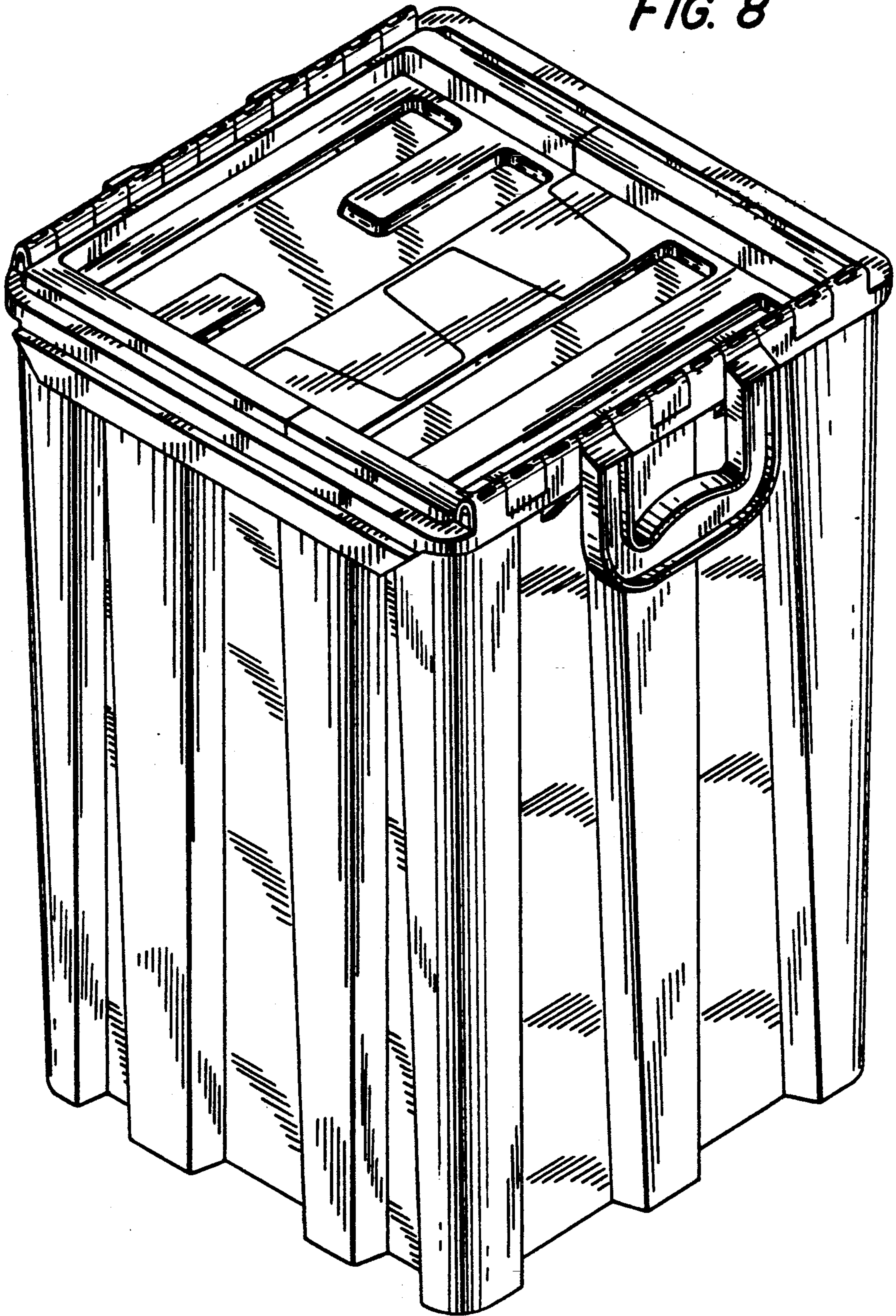

FIG. 9

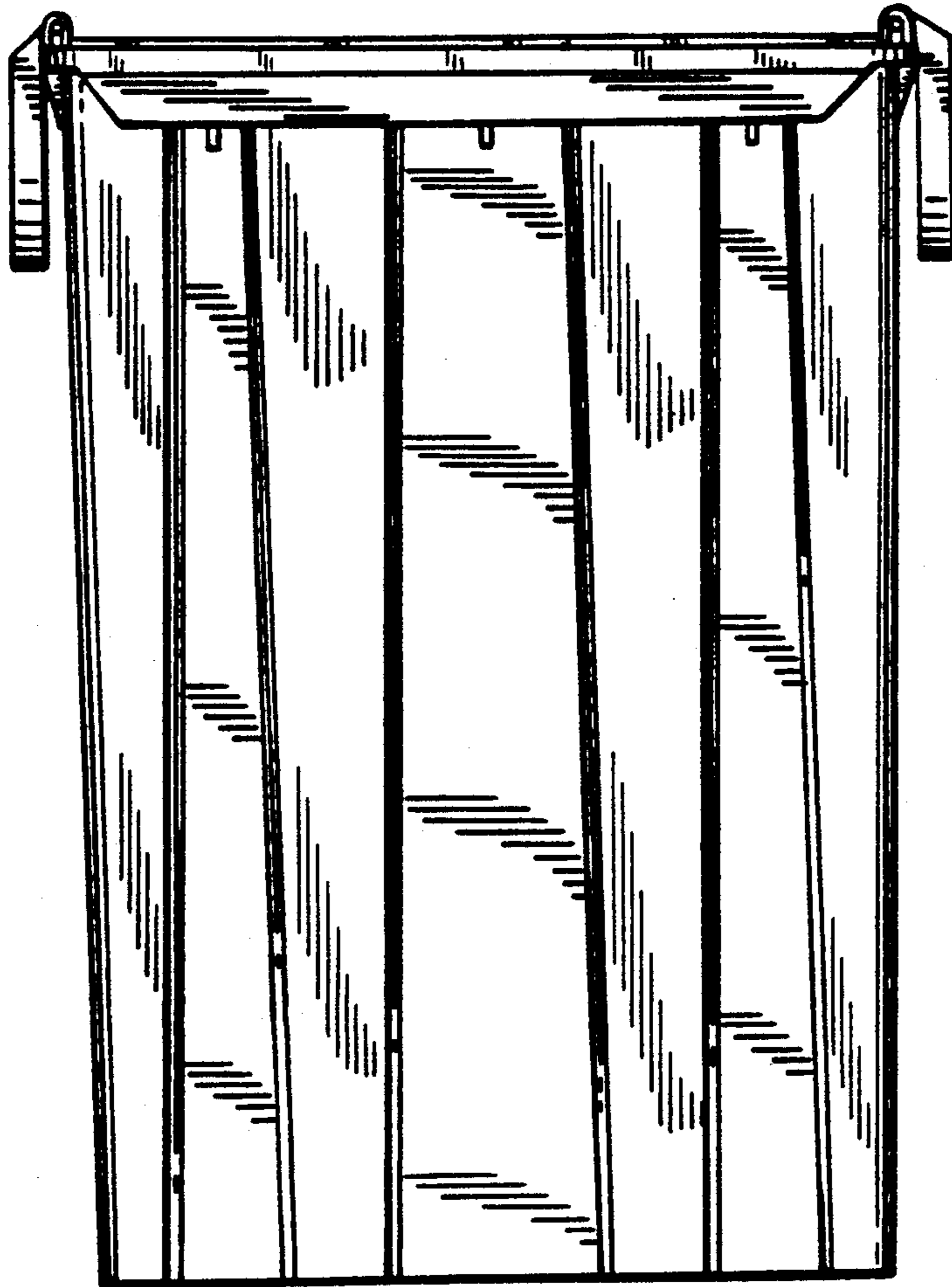
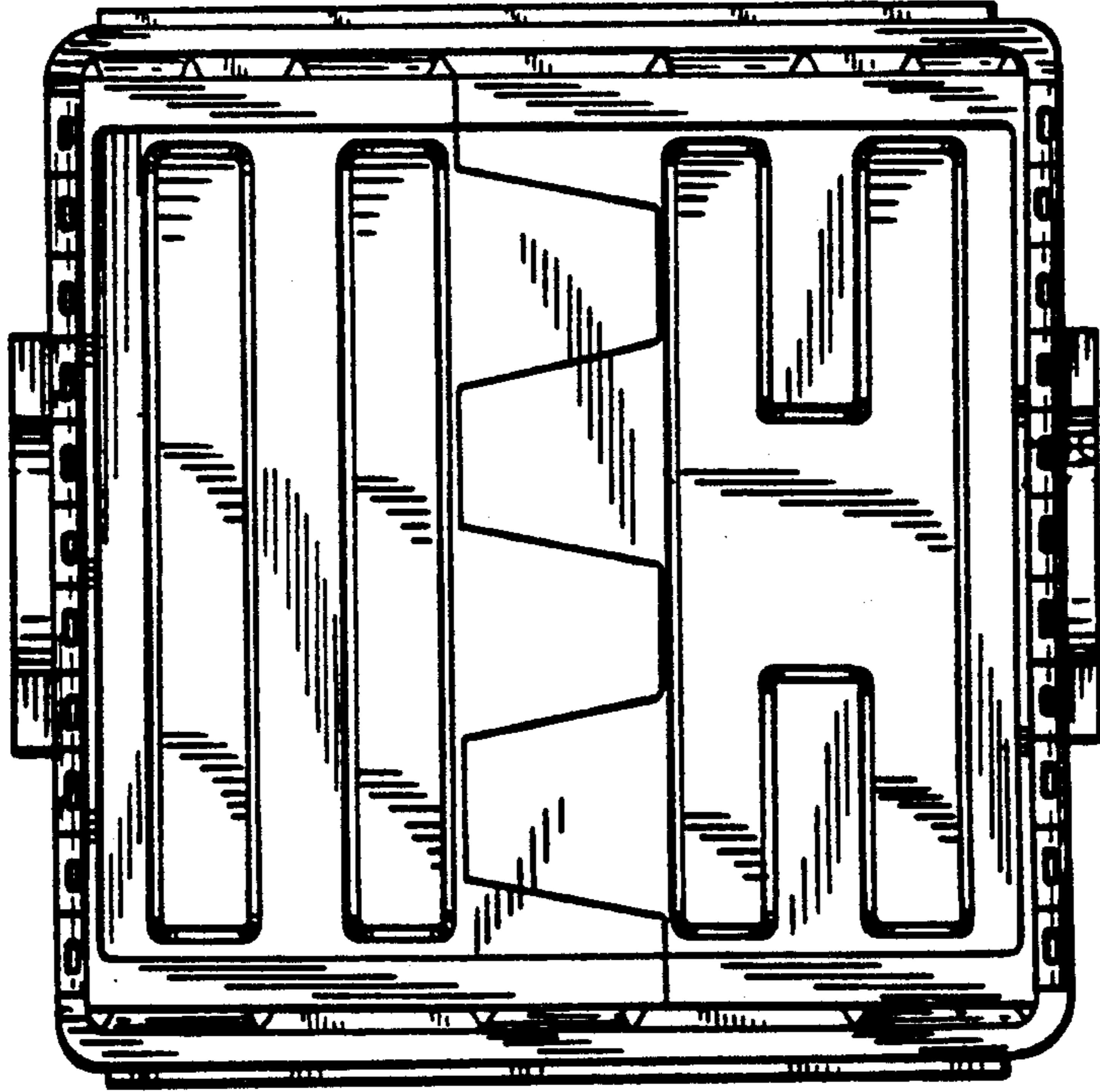

FIG. 10

FIG. 11

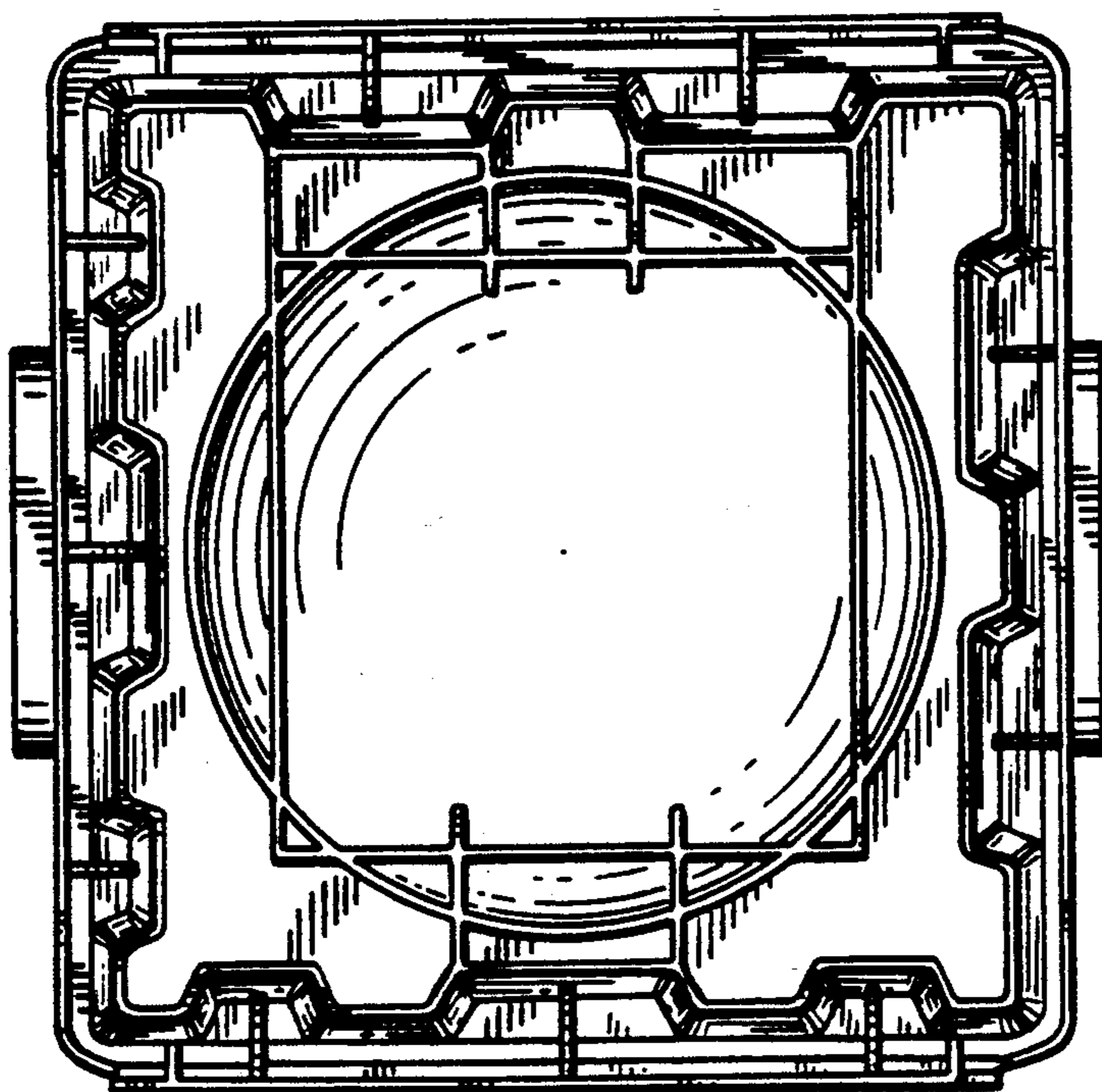
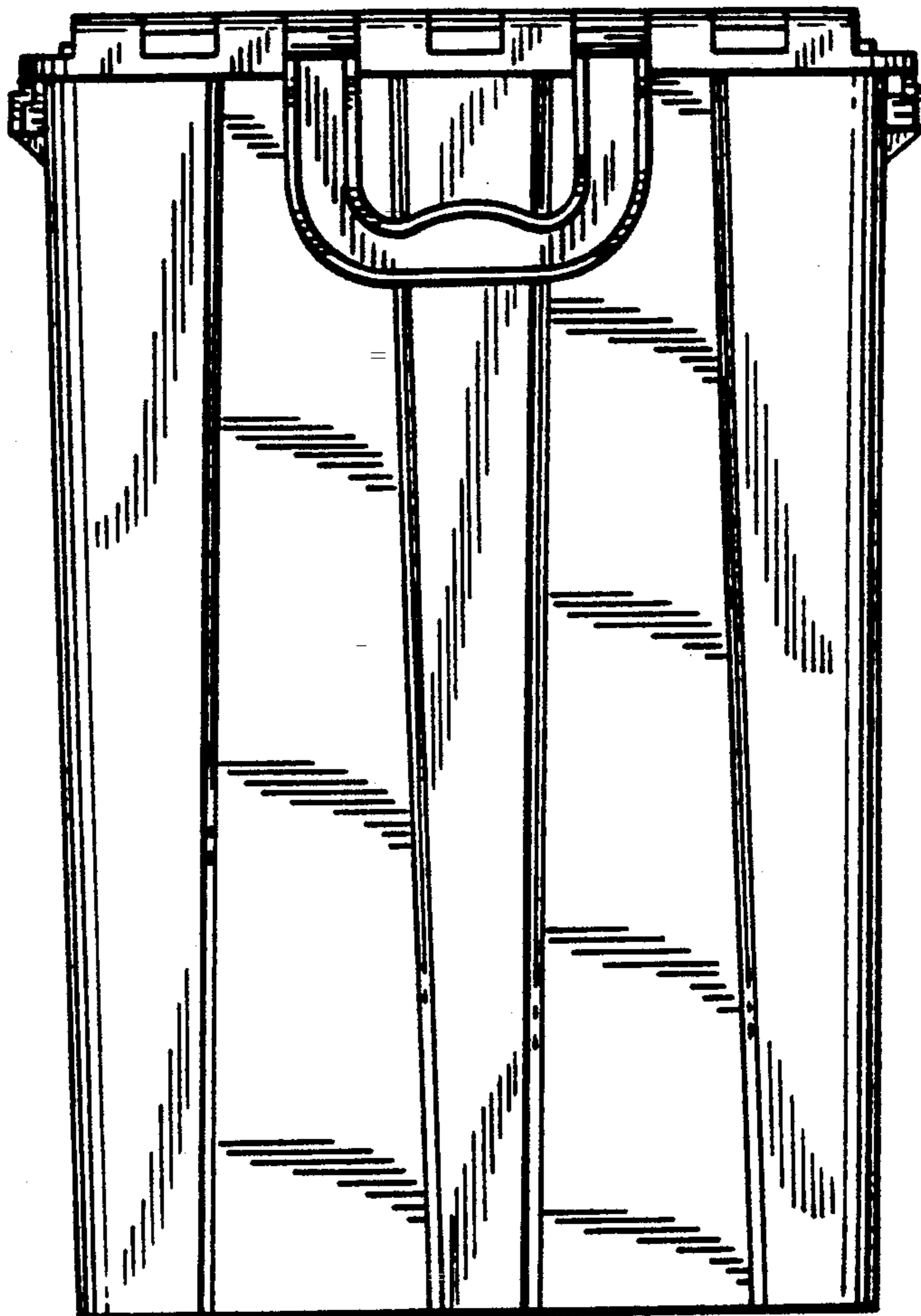

FIG. 12

FIG. 14

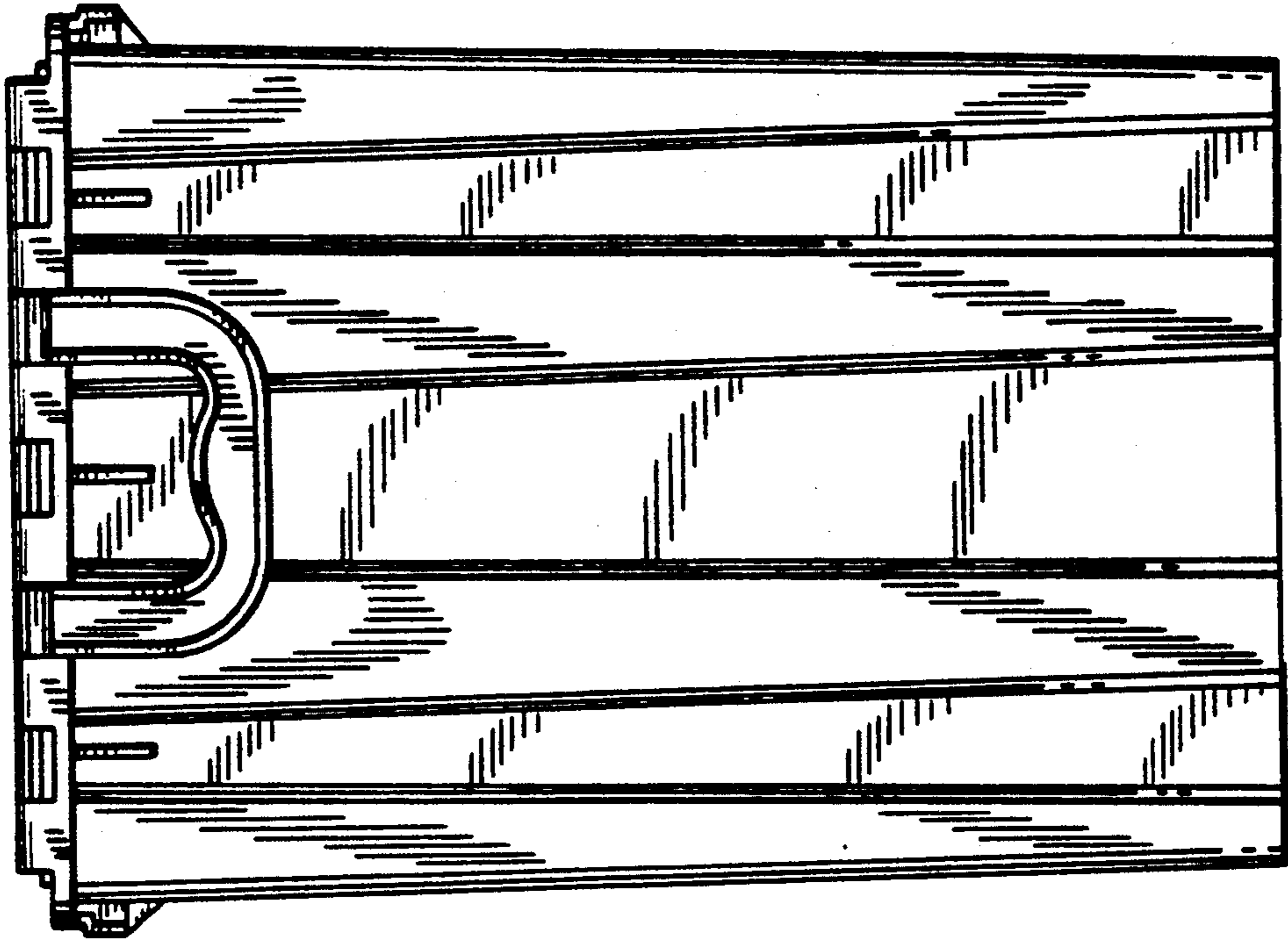

FIG. 13

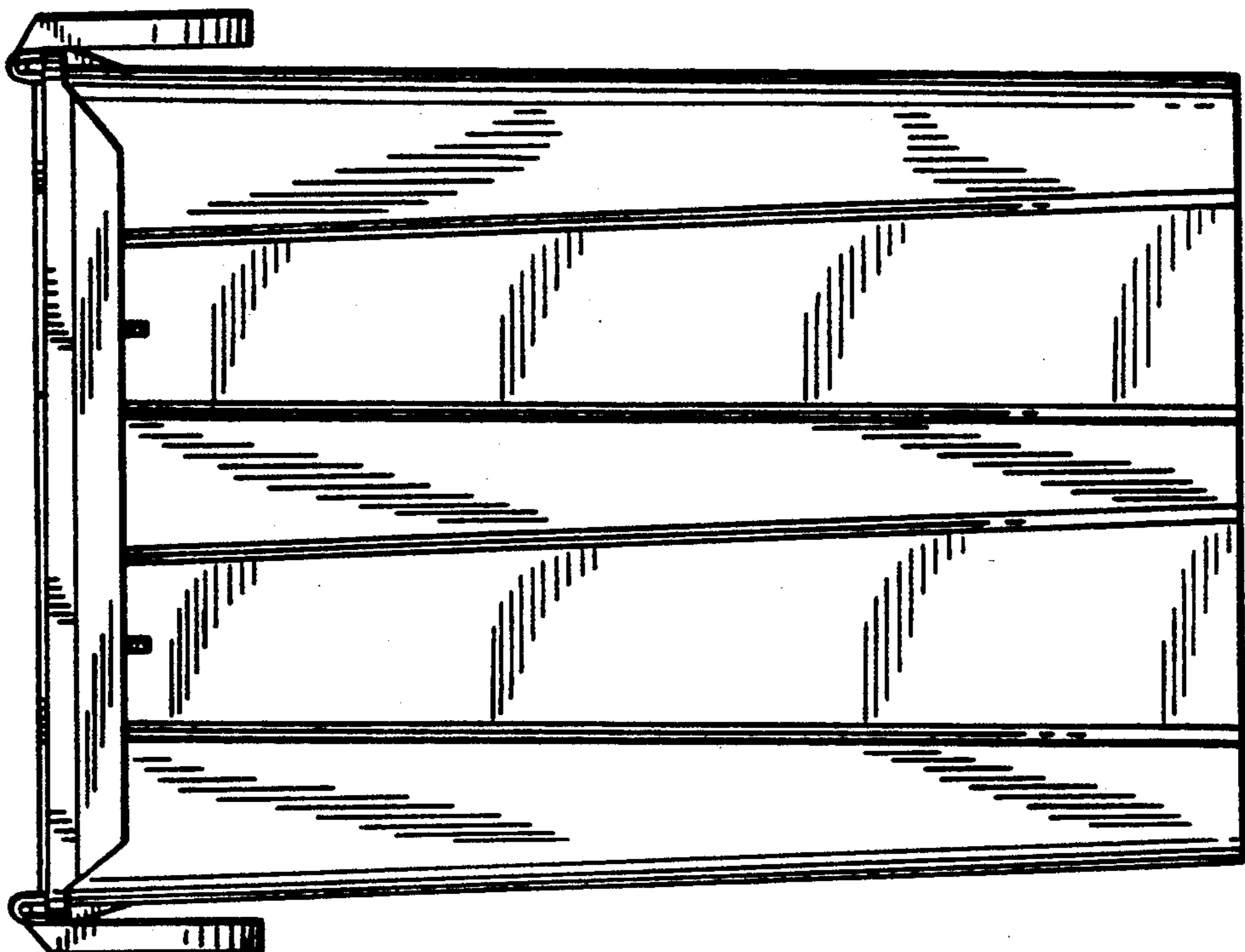

FIG. 15

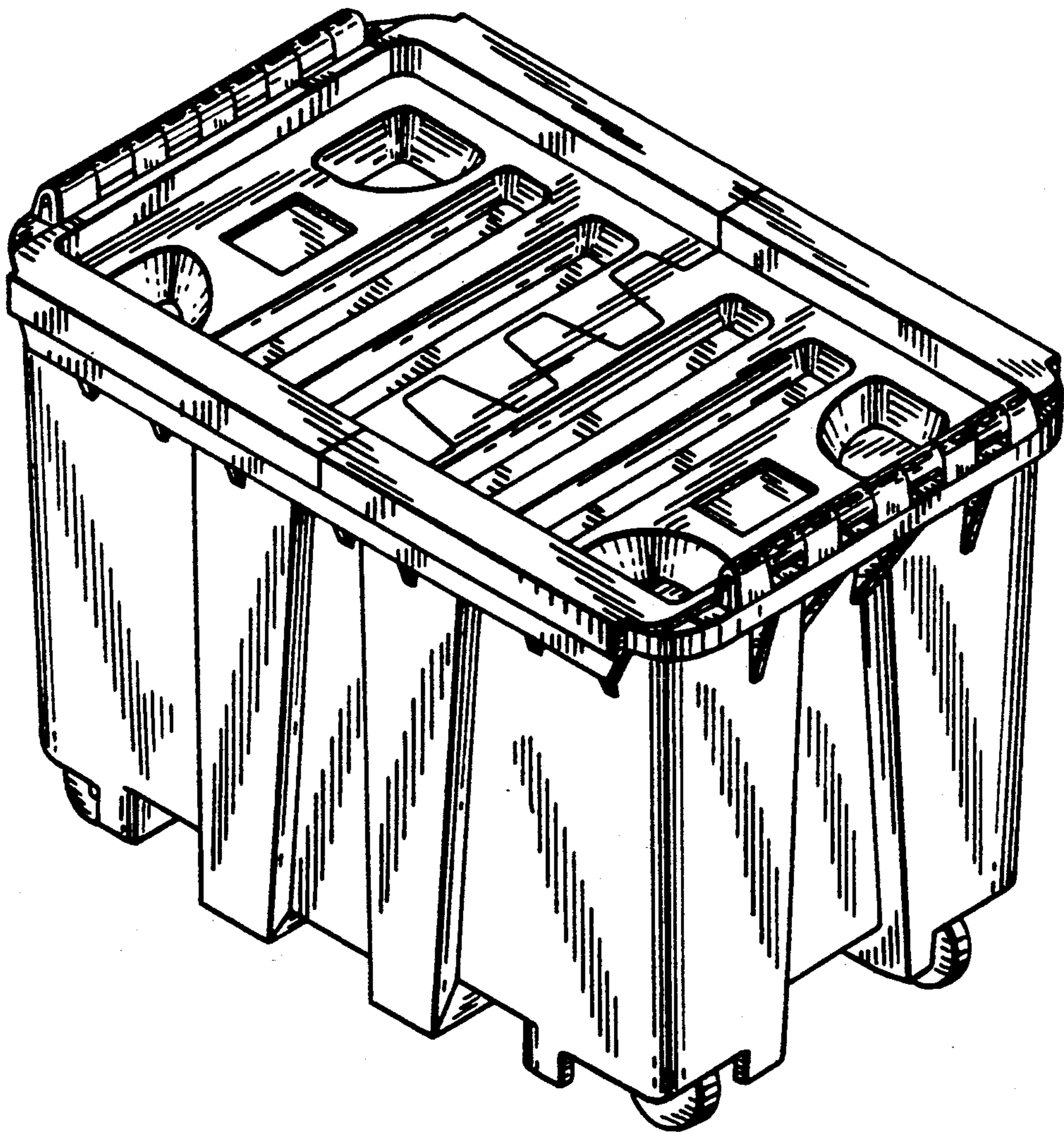

FIG. 16

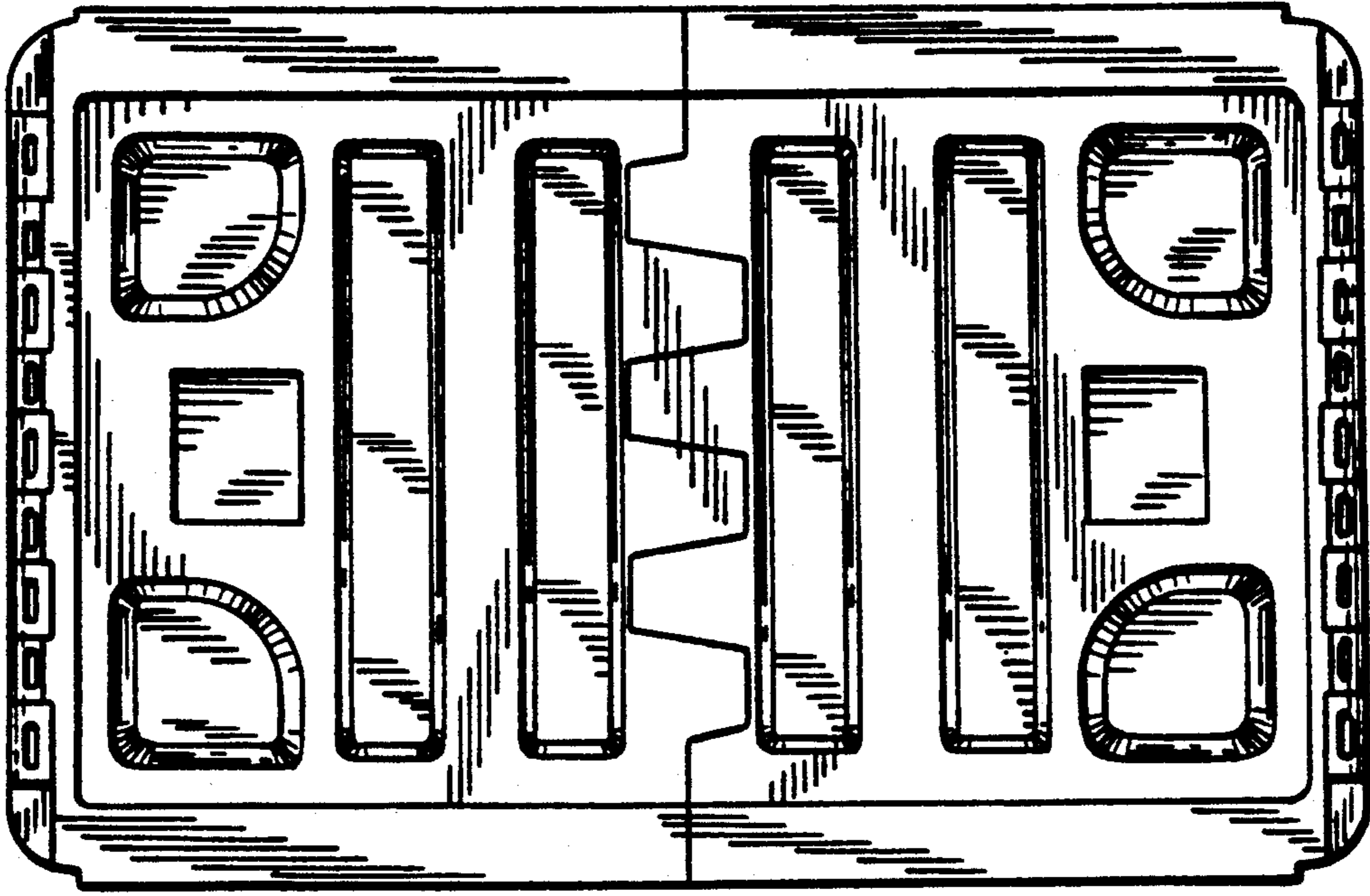

FIG. 17

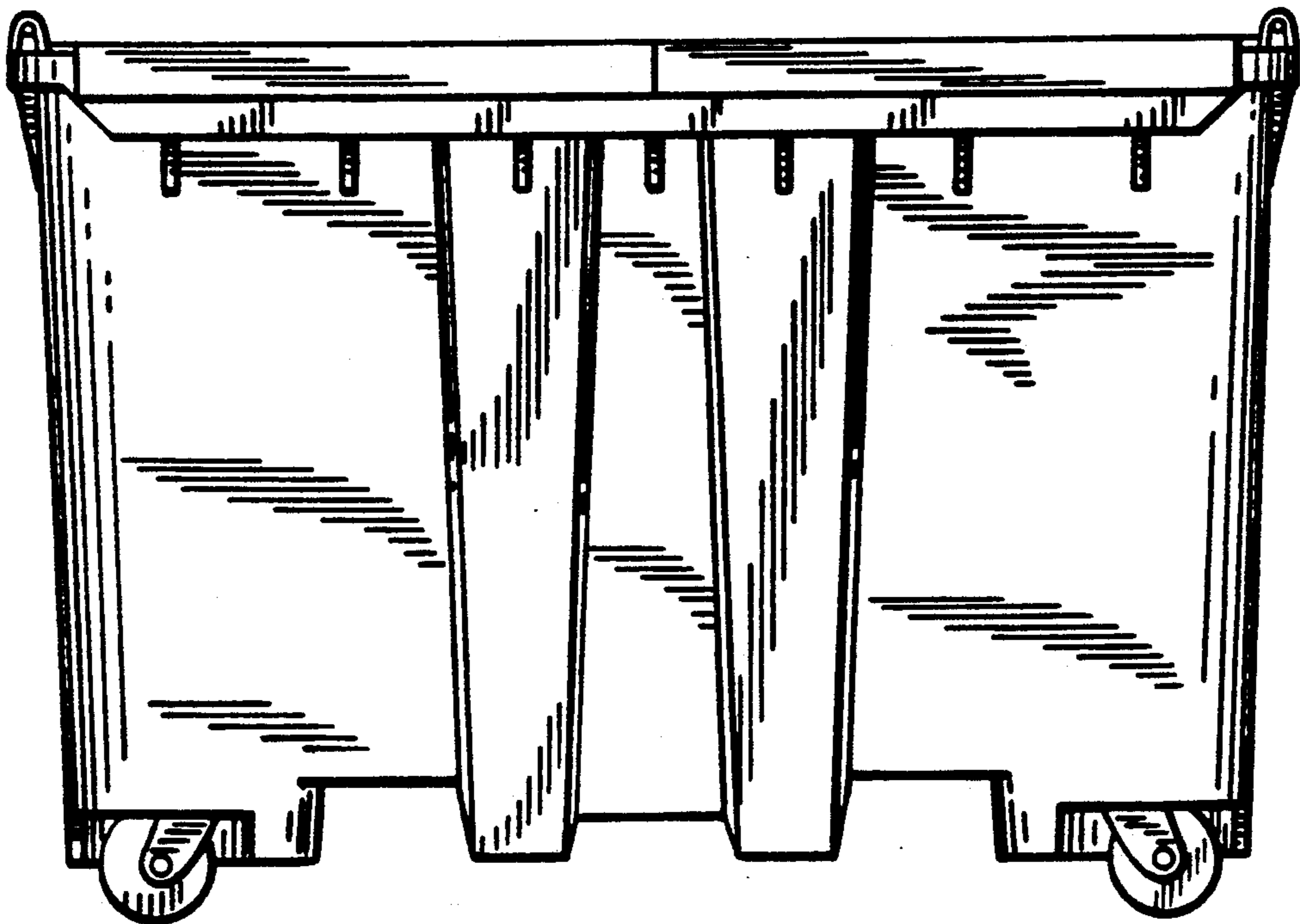

FIG. 18

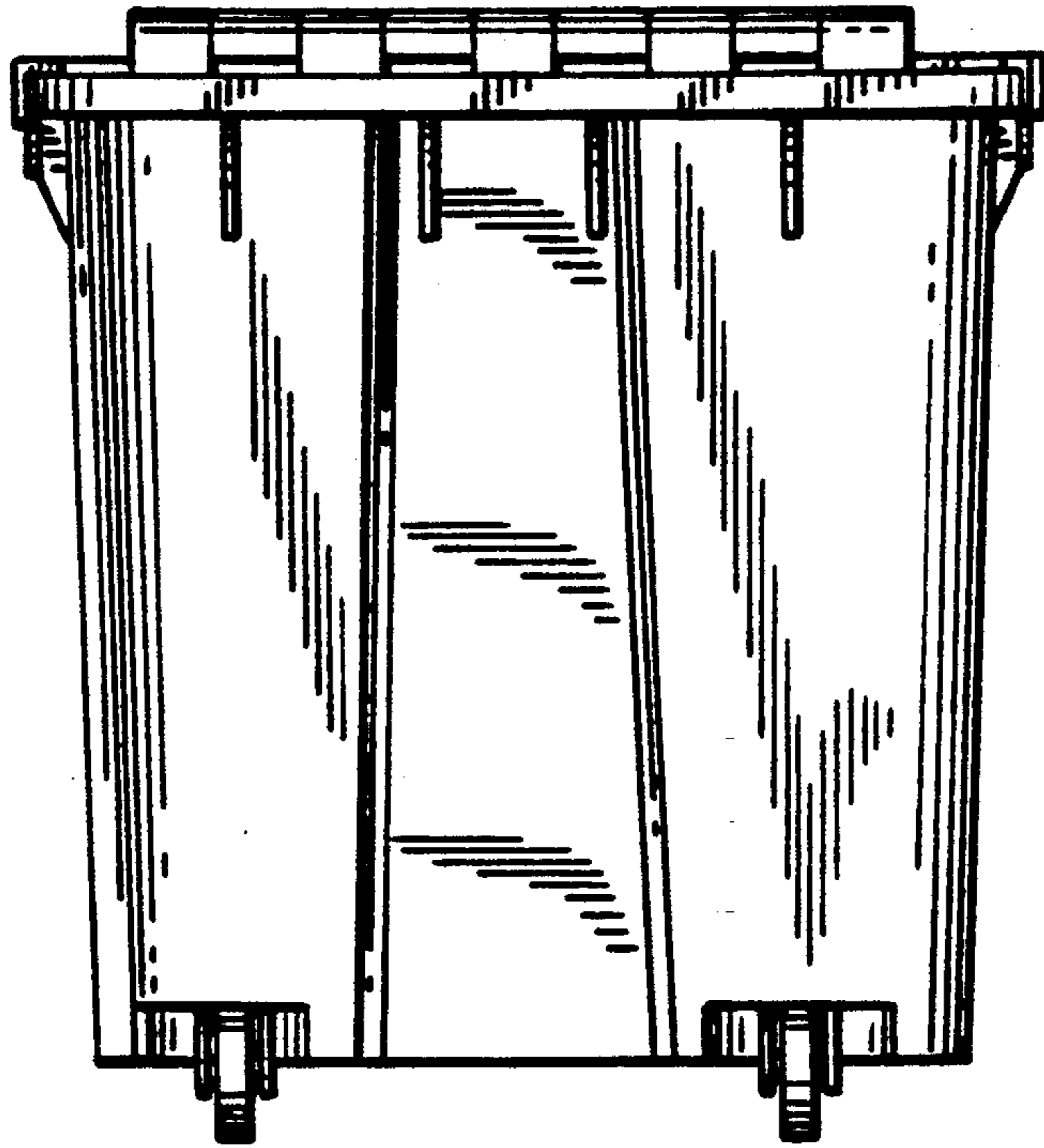

FIG. 19

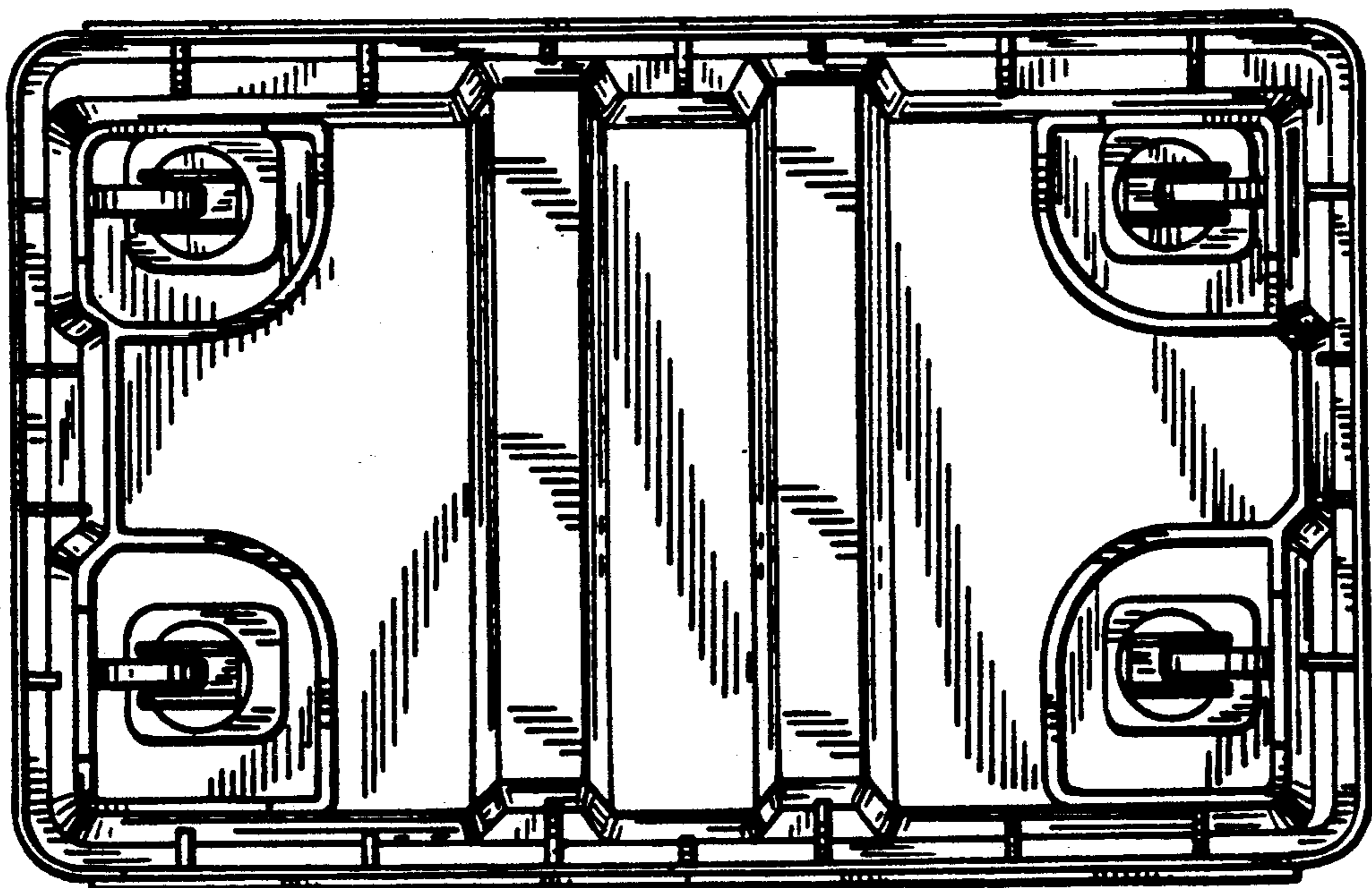

FIG. 20

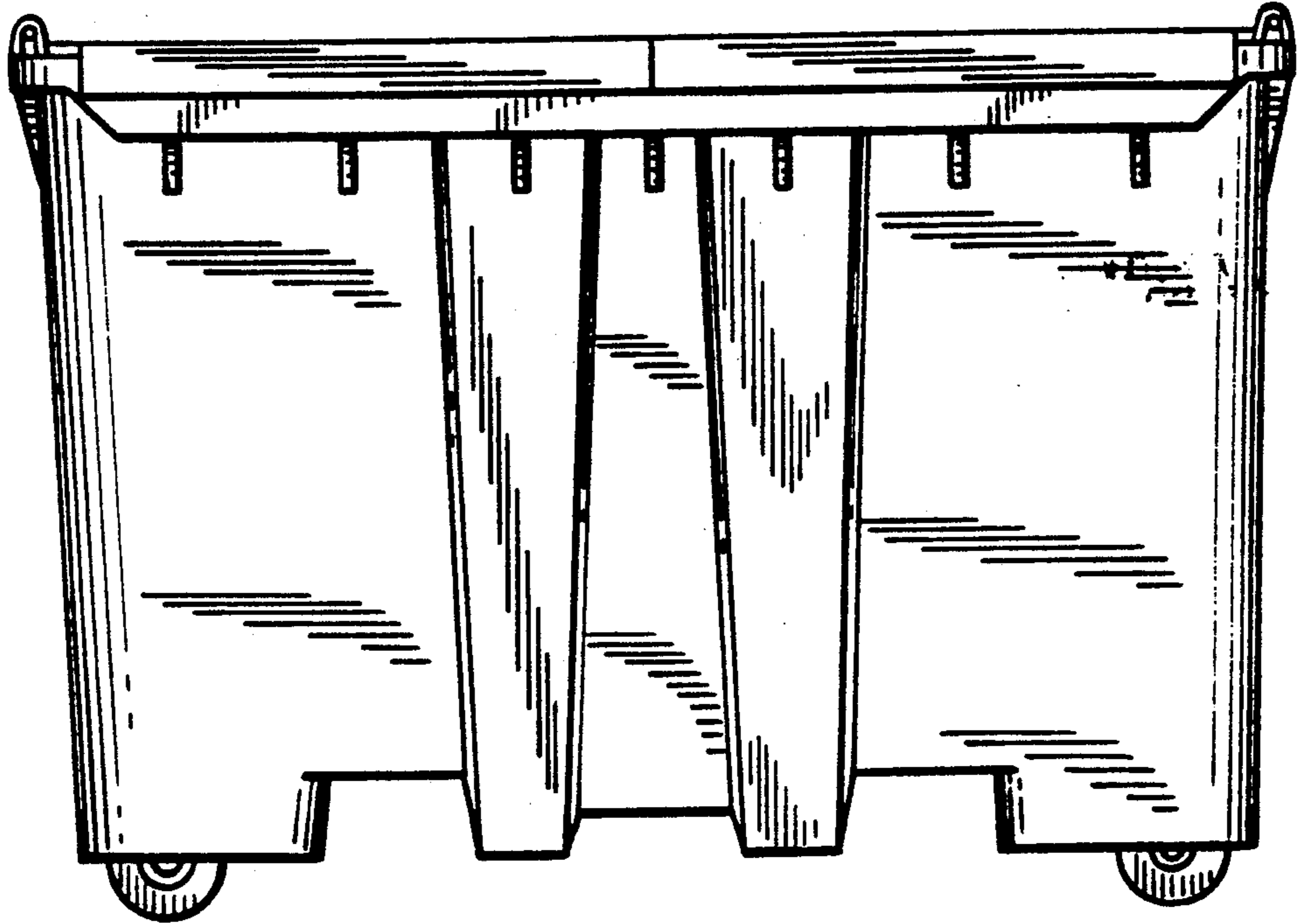

FIG. 21

