



US00D333812S

United States Patent [19]

[11] Patent Number: **Des. 333,812**

Krasser

[45] Date of Patent: **** Mar. 9, 1993**

[54] CIRCUIT BREAKER

[75] Inventor: **Fritz Krasser, Altdorf, Fed. Rep. of Germany**

[73] Assignee: **Ellenberger & Poensgen GmbH, Altdorf, Fed. Rep. of Germany**

[**] Term: **14 Years**

[21] Appl. No.: **663,634**

[22] Filed: **Mar. 4, 1991**

[52] U.S. Cl. **D13/160; D13/171**

[58] Field of Search **D13/160, 171; 200/3, 200/293, DIG. 28; 337/107, 113**

[56] References Cited

U.S. PATENT DOCUMENTS

D. 190,496	6/1961	Ellenberger	D13/171
3,031,542	4/1962	Ellenberger	337/113
3,840,834	10/1974	Obenhaus et al.	377/107 X
4,780,698	10/1988	Tomkinson et al.	337/113

OTHER PUBLICATIONS

A-1059 circuit breakers.

Primary Examiner—Wallace R. Burke

Assistant Examiner—Joel Sincavage

Attorney, Agent, or Firm—Kokjer, Kircher, Bowman & Johnson

[57] CLAIM

The ornamental design for a circuit breaker, as shown and described.

DESCRIPTION

FIG. 1 is a front elevational view of a circuit breaker showing my new design;

FIG. 2 is a left side elevational view thereof;

FIG. 3 is a right side elevational view thereof;

FIG. 4 is a rear elevational view thereof;

FIG. 5 is a top plan view thereof;

FIG. 6 is a bottom plan view thereof; and,

FIG. 7 is a front elevational view of a circuit breaker showing a second embodiment of the design. The plan views and the other elevational view are the same as the first embodiment except for the appearance of the lever.

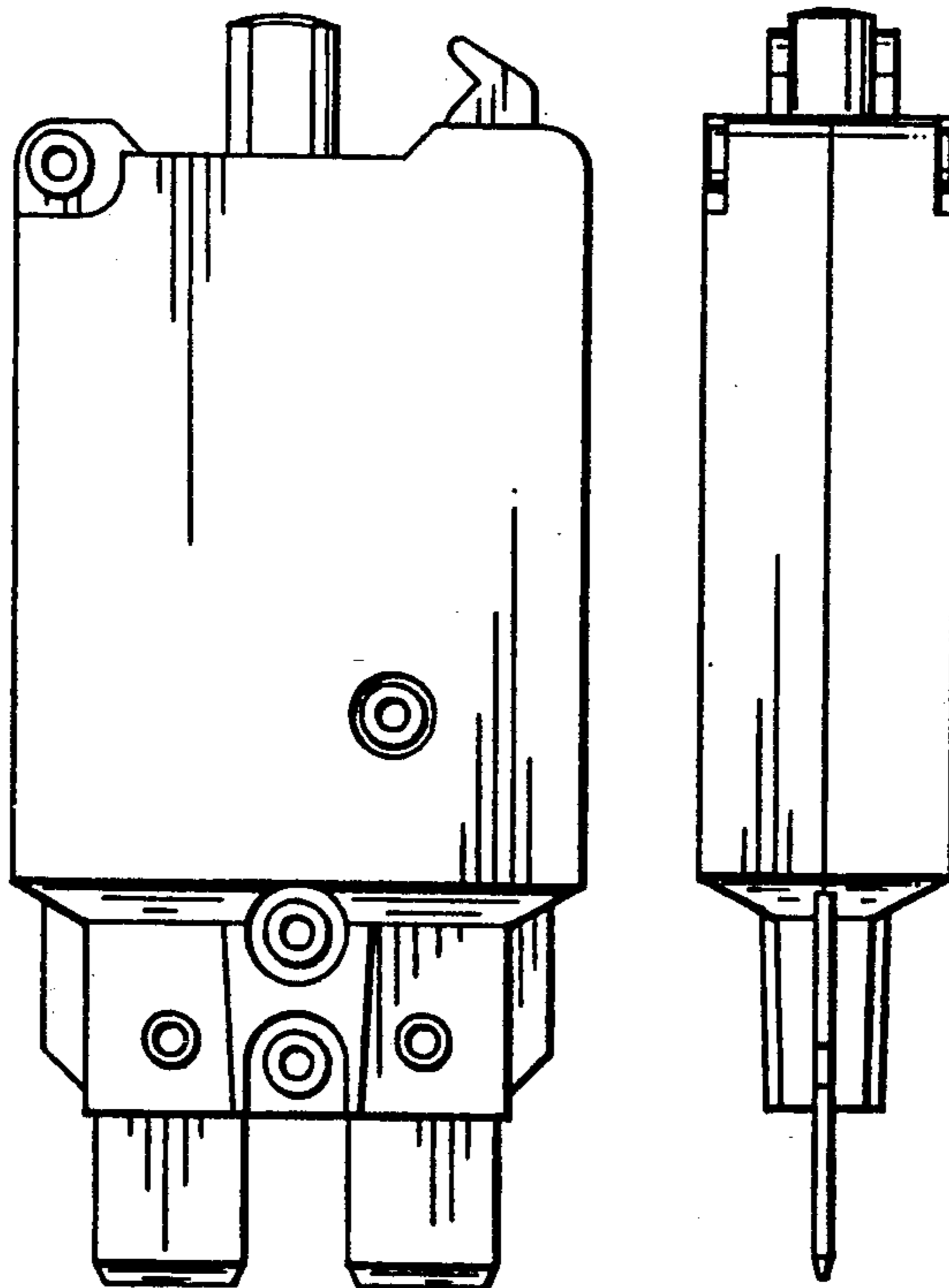

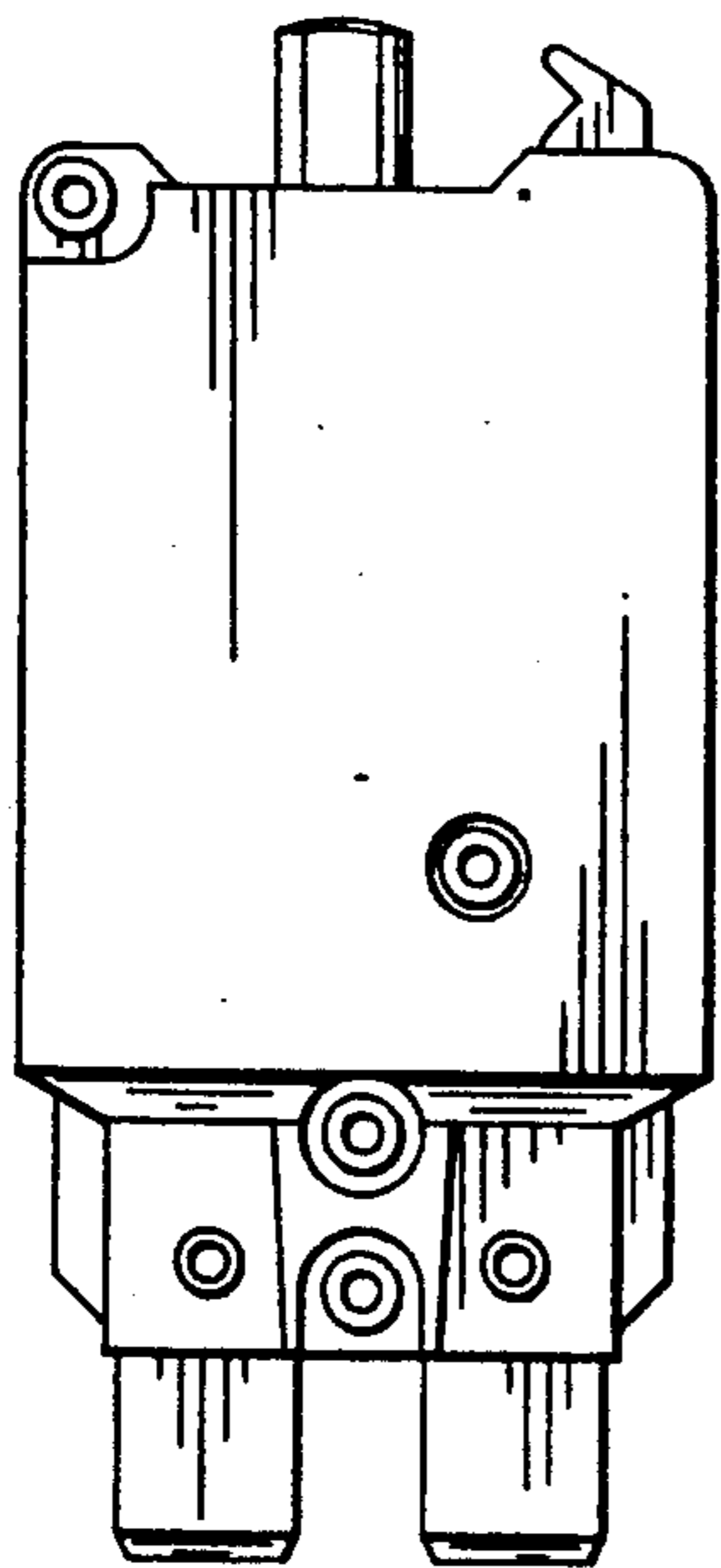

Fig. 1.



Fig. 2.

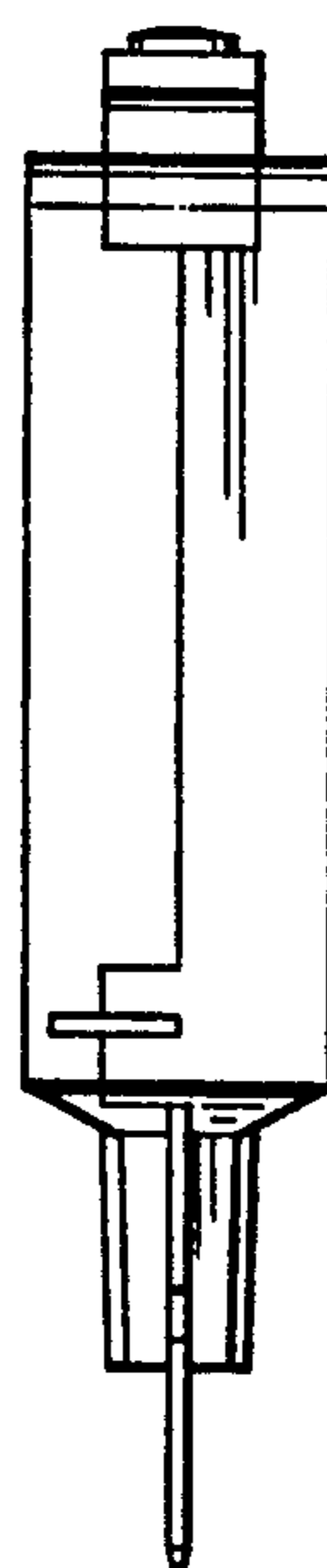

Fig. 3.

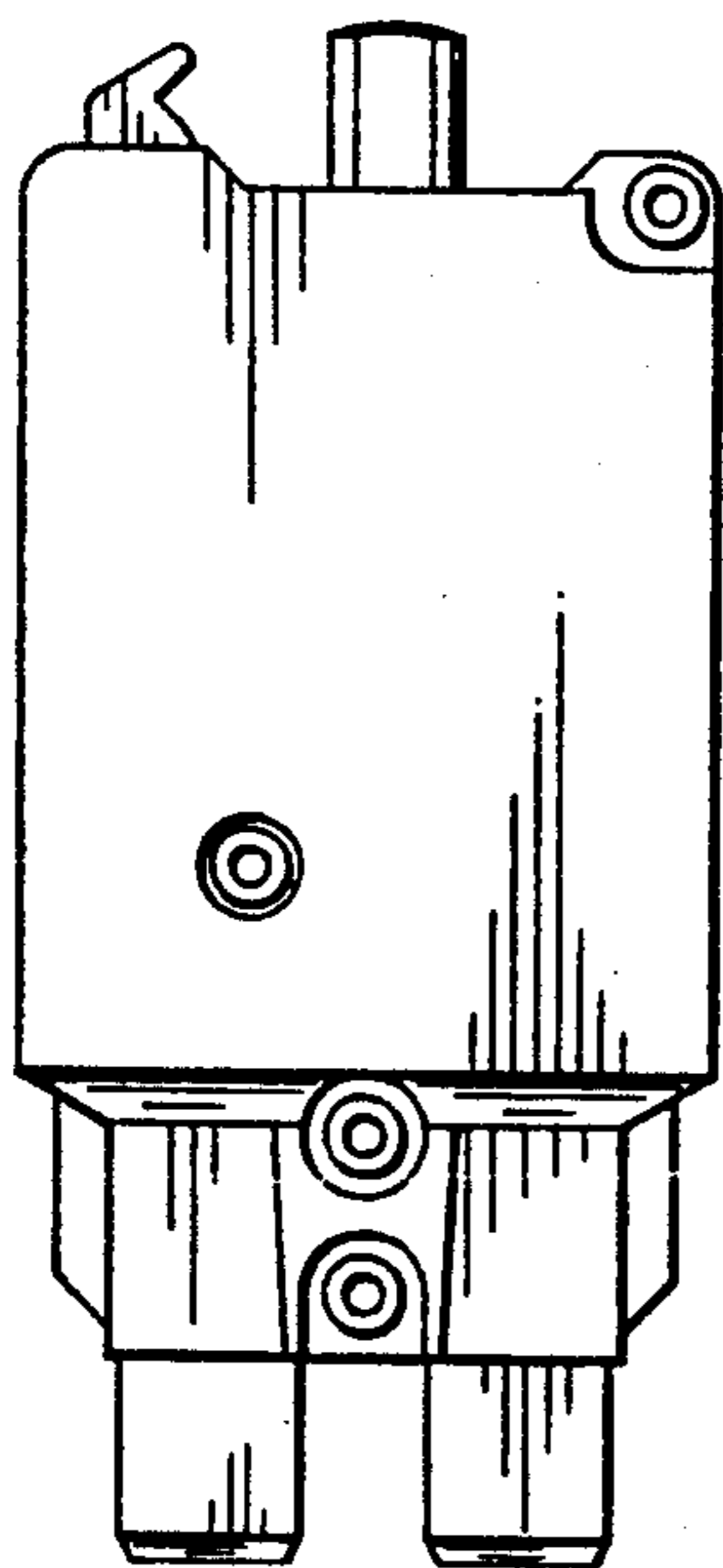

Fig. 4.

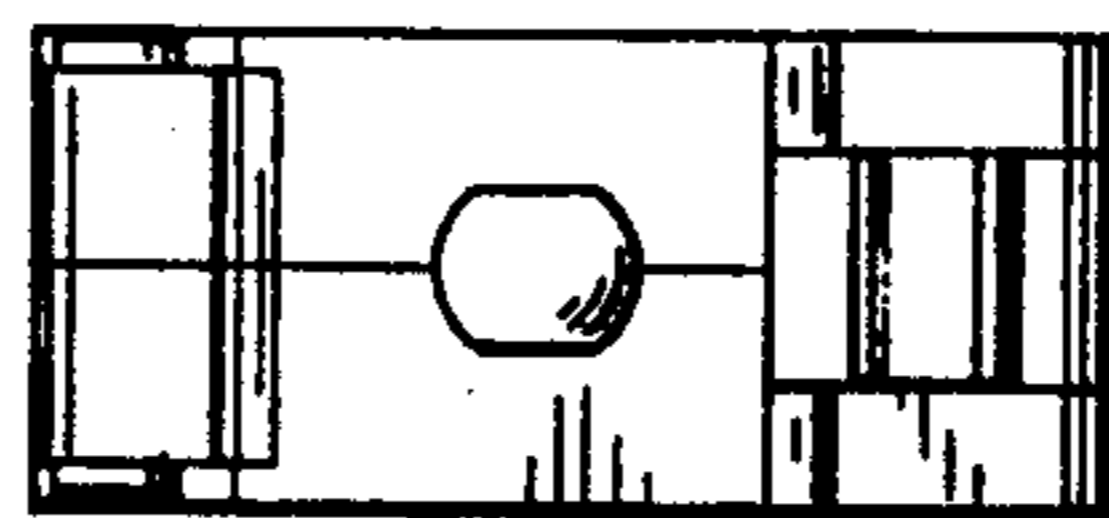

Fig. 5.

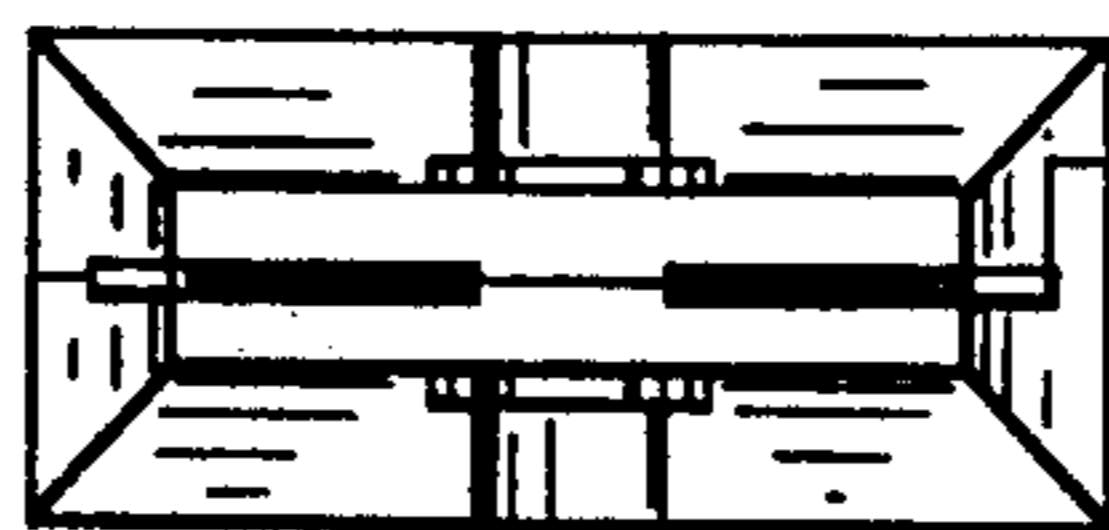

Fig. 6.

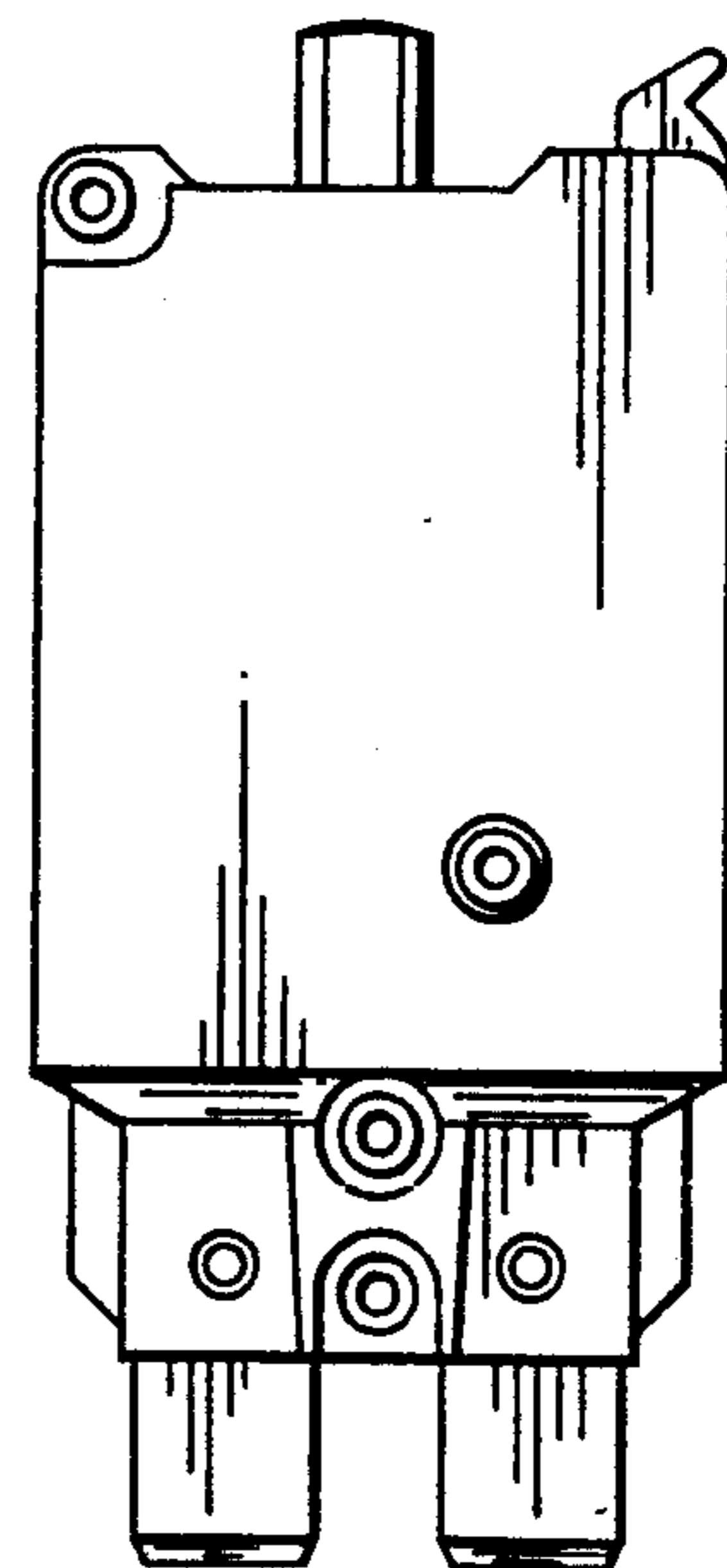

Fig. 7.