



US00D333774S

United States Patent [19]

[11] Patent Number: **Des. 333,774**

Bisch

[45] Date of Patent: **** Mar. 9, 1993**

[54] HANDLE FOR A KNIFE BLADE

4,703,561 11/1987 Parisek 30/298
4,959,905 10/1990 Ghislain 30/298.4

[76] Inventor: **Steven C. Bisch, 119 W. 8th Ave.,
Conshohocken, Pa. 19428**

Primary Examiner—Bernard Ansher
Assistant Examiner—Philip Hyder
Attorney, Agent, or Firm—Leon Gilden

[**] Term: **14 Years**

[21] Appl. No.: **574,944**

[57] **CLAIM**

[22] Filed: **Aug. 30, 1990**

The ornamental design for a handle for a knife blade, as shown and described.

[52] U.S. Cl. **D8/107**

[58] Field of Search **D8/107; D21/108;
30/151, 169, 298, 299, 298.4, 305, 296.1, 294,
340**

DESCRIPTION

FIG. 1 is a front elevational view of the handle for a knife blade showing my new design;
FIG. 2 is a rear elevational view thereof;
FIG. 3 is a left side elevational view thereof;
FIG. 4 is a right side elevational view thereof;
FIG. 5 is a top plan view thereof;
FIG. 6 is a bottom plan view thereof; and,
FIG. 7 is a perspective view thereof.

[56] **References Cited**

U.S. PATENT DOCUMENTS

2,902,713 9/1959 Buelow 30/299
4,202,093 5/1980 Wallerstein 30/169
4,612,707 9/1986 Shea 30/169

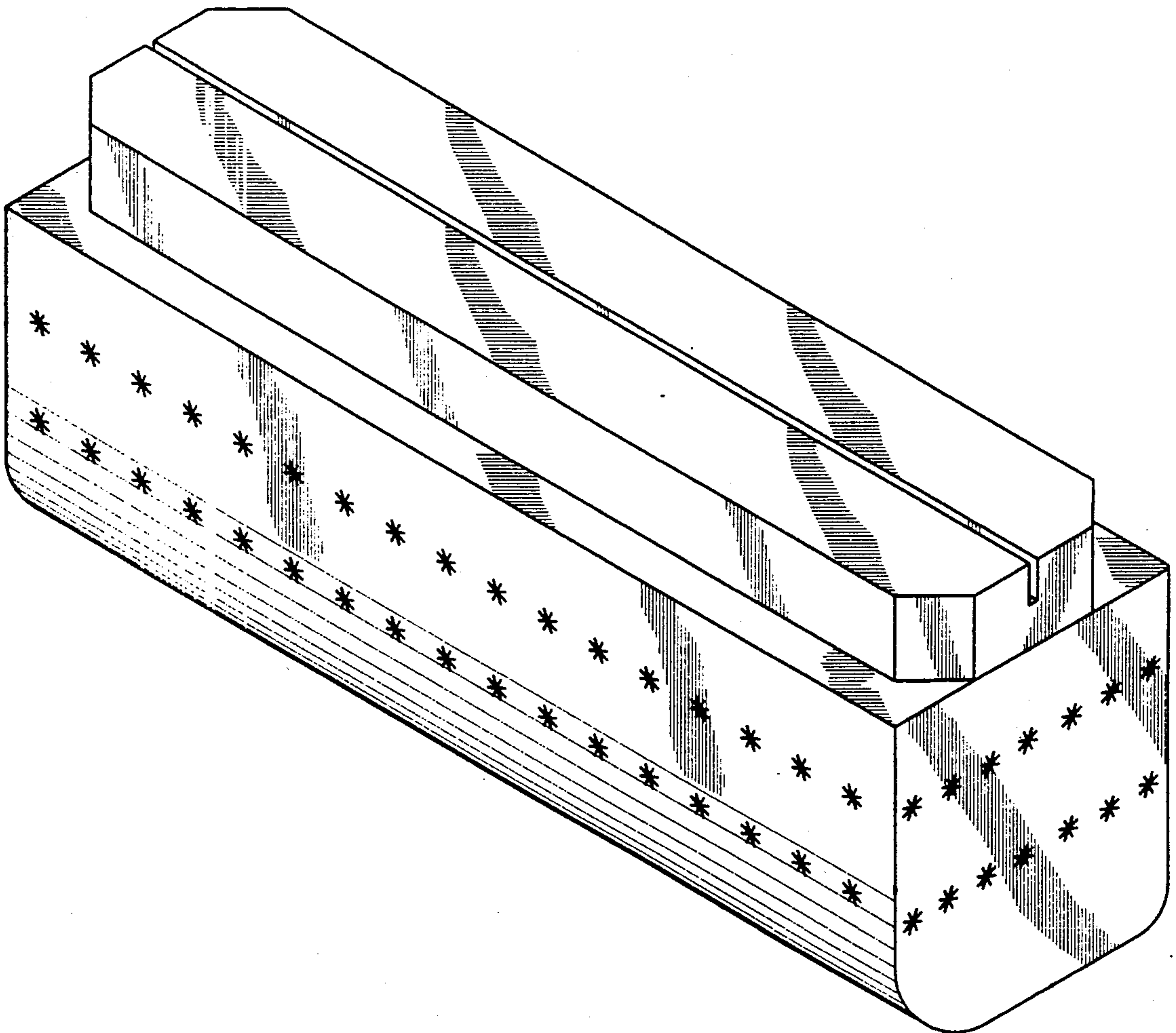

FIG. 1

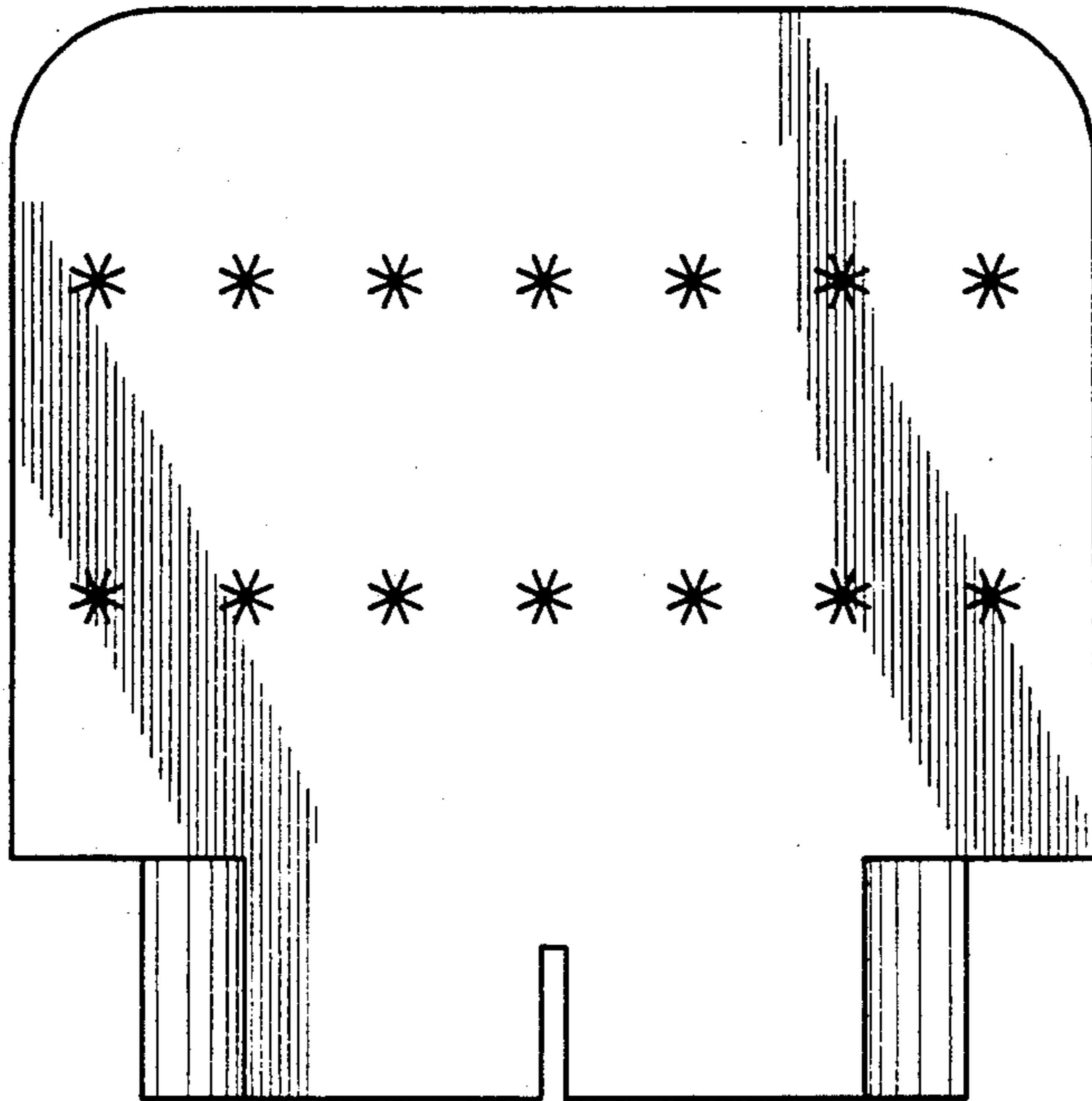

FIG. 2

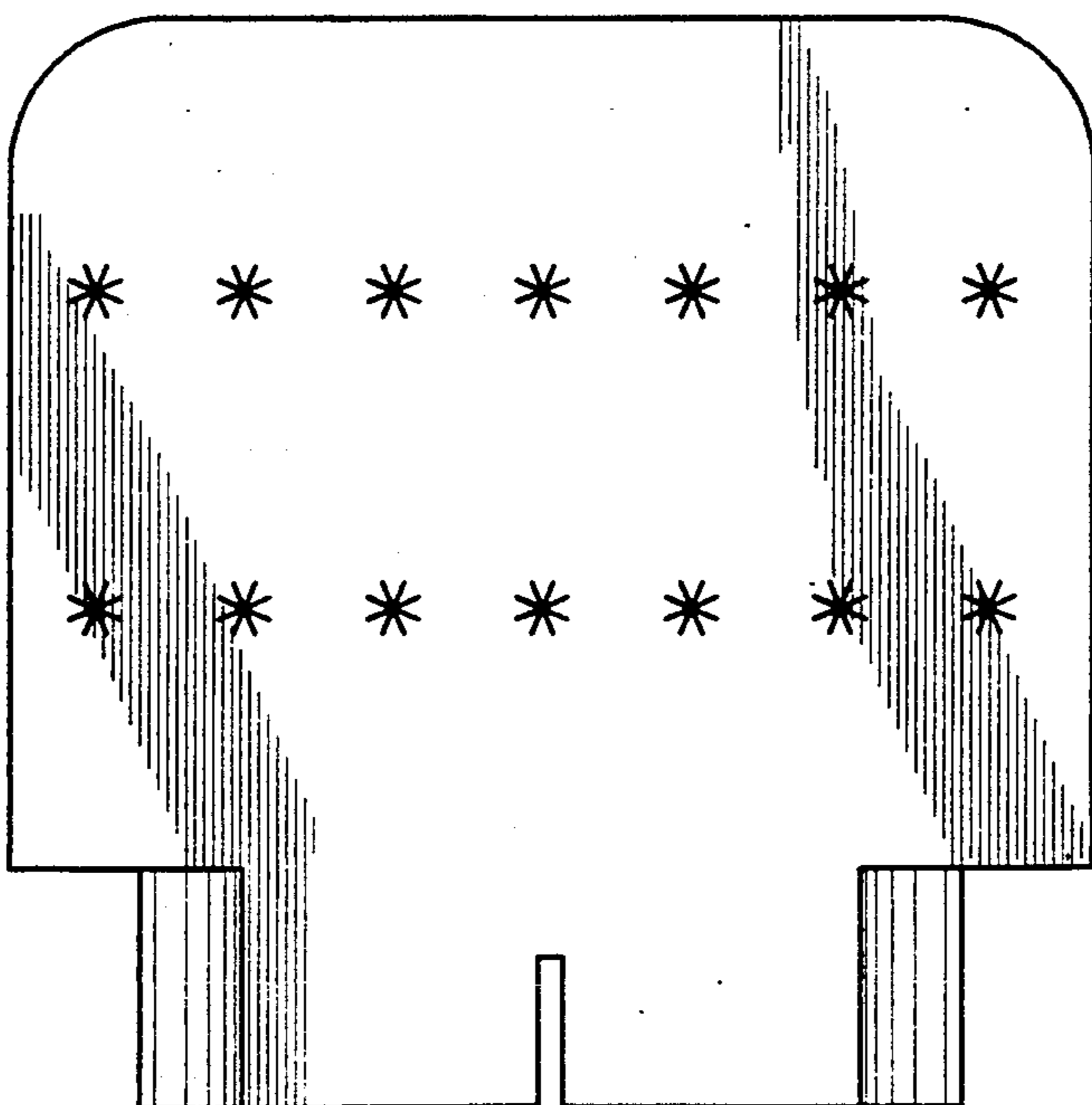

FIG. 3

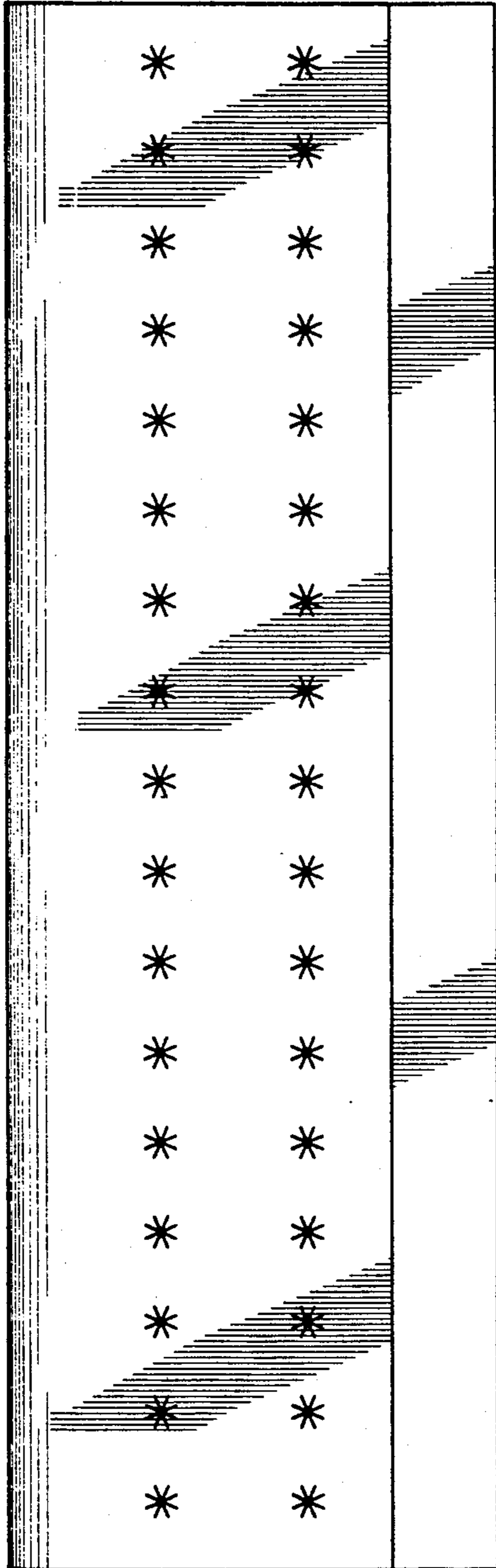

FIG. 4

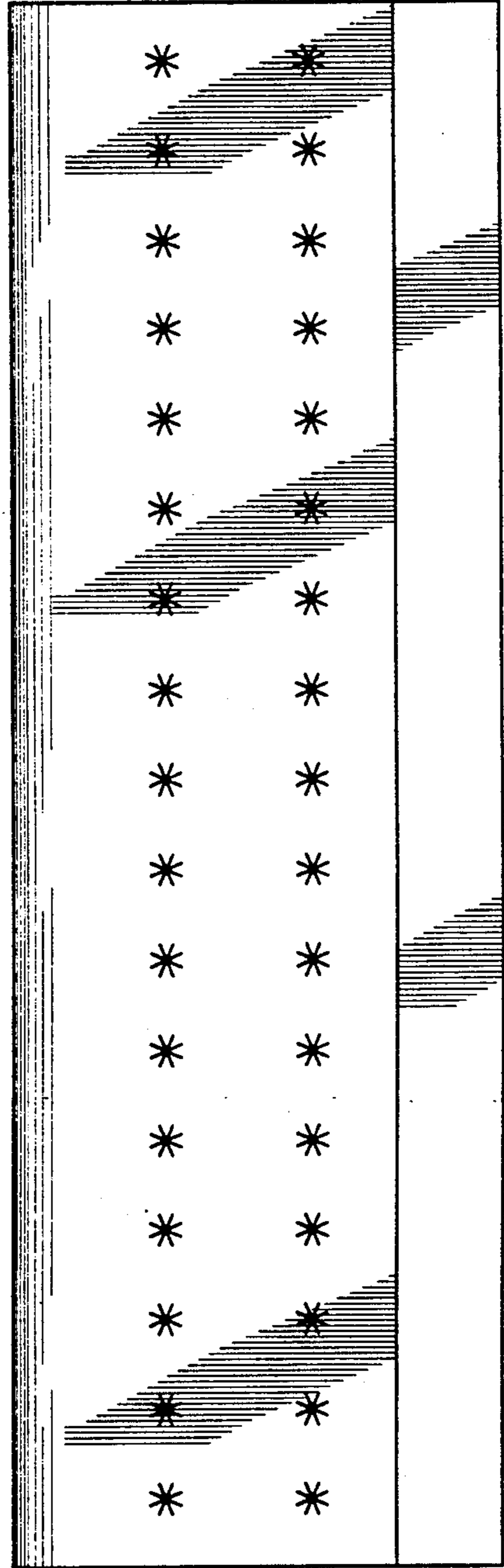

FIG. 5

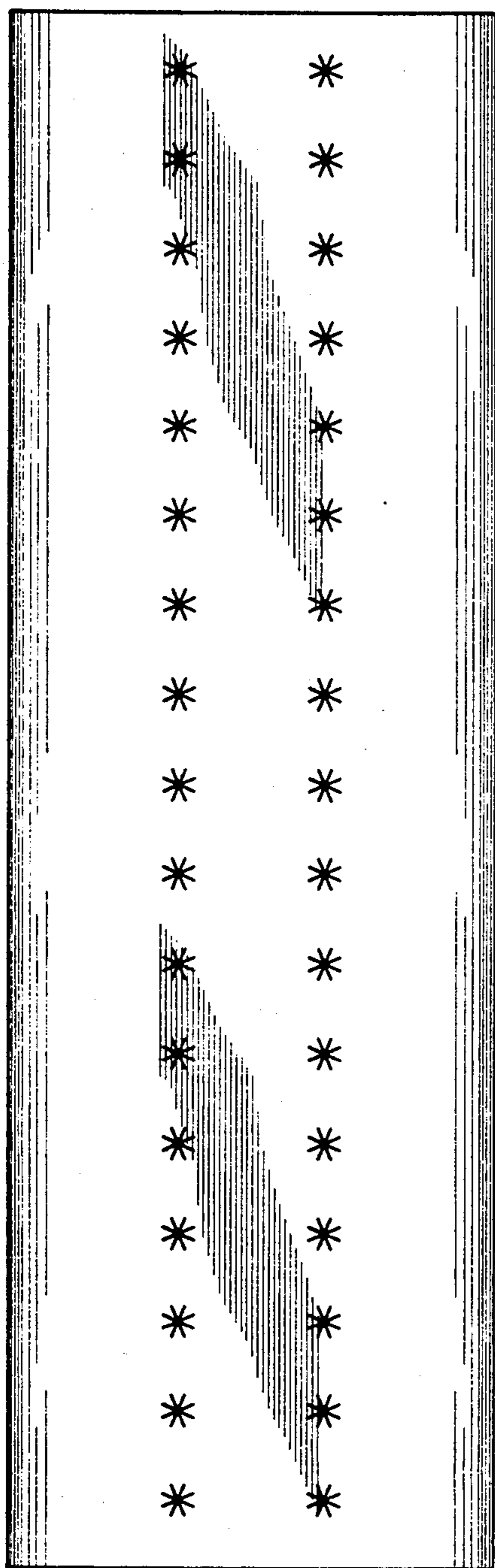

FIG. 6

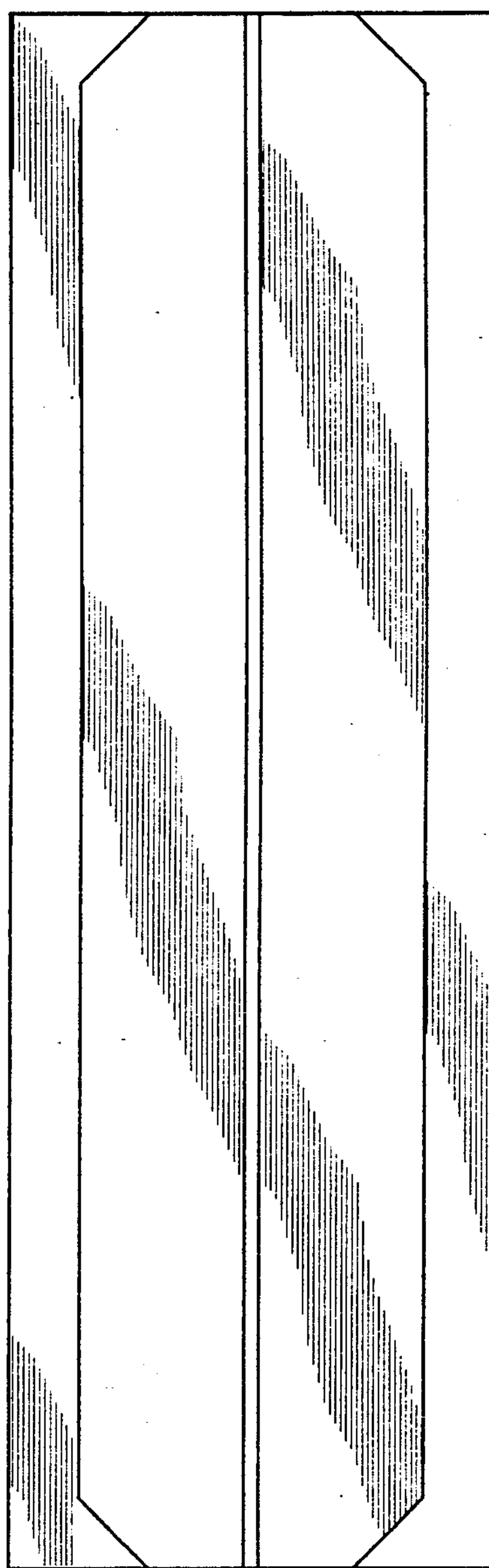

FIG. 7

