



US00D333763S

United States Patent [19]

[11] Patent Number: **Des. 333,763**

Collins

[45] Date of Patent: **** Mar. 9, 1993**

[54] **PLANT WATERER**

[76] Inventor: **Rita Collins, 2462 N. Nye #131, Fremont, Nebr. 68025**

[**] Term: **14 Years**

[21] Appl. No.: **654,555**

[22] Filed: **Feb. 12, 1991**

[52] U.S. Cl. **D8/1; D23/200**

[58] Field of Search **47/48.5, 59, 79-81; 222/187, 561, 566; 239/10, 37, 43, 63, 128, 315, 565, 38, 34; D23/200; D8/1**

4,060,934	12/1977	Skaggs	47/79
4,115,951	9/1978	Becker .	
4,315,599	2/1982	Biancardi .	
4,760,666	8/1988	Han	47/79
4,866,880	9/1989	Weinblatt	47/79

Primary Examiner—Wallace R. Burke
Assistant Examiner—M. H. Tung
Attorney, Agent, or Firm—Terry M. Gernstein

[57] CLAIM

The ornamental design for plant waterer, as shown and described.

[56] References Cited

U.S. PATENT DOCUMENTS

D. 103,140	2/1937	Wettstein	D8/1
D. 158,596	5/1950	Lack	D8/1
D. 175,849	10/1955	Moore, Jr. et al.	D8/1
D. 239,962	5/1976	Von Till	D23/214 X
3,438,575	4/1969	Rohling .	
3,739,523	6/1973	Tuffli	47/81
3,903,815	9/1975	Winkler	47/48.5 X

DESCRIPTION

FIG. 1 is a perspective view of a plant waterer showing my new design;
FIG. 2 is a front elevational view thereof;
FIG. 3 is a rear elevational view thereof;
FIG. 4 is a side elevational view thereof, the opposite side being a mirror image;
FIG. 5 is a top plan view thereof; and,
FIG. 6 is a bottom plan view thereof.

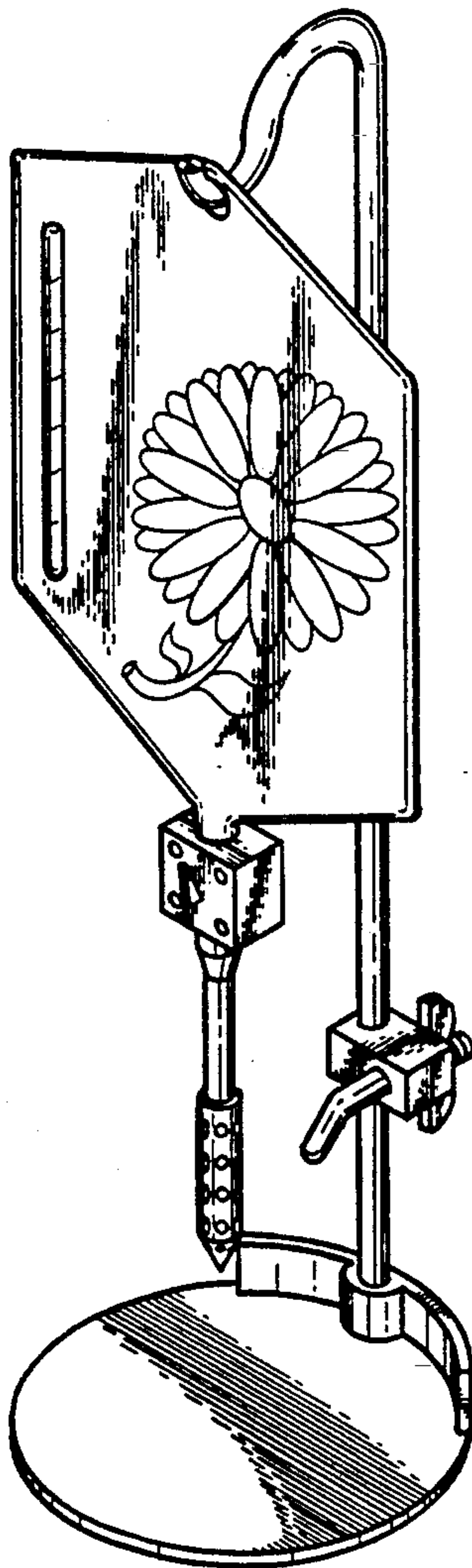

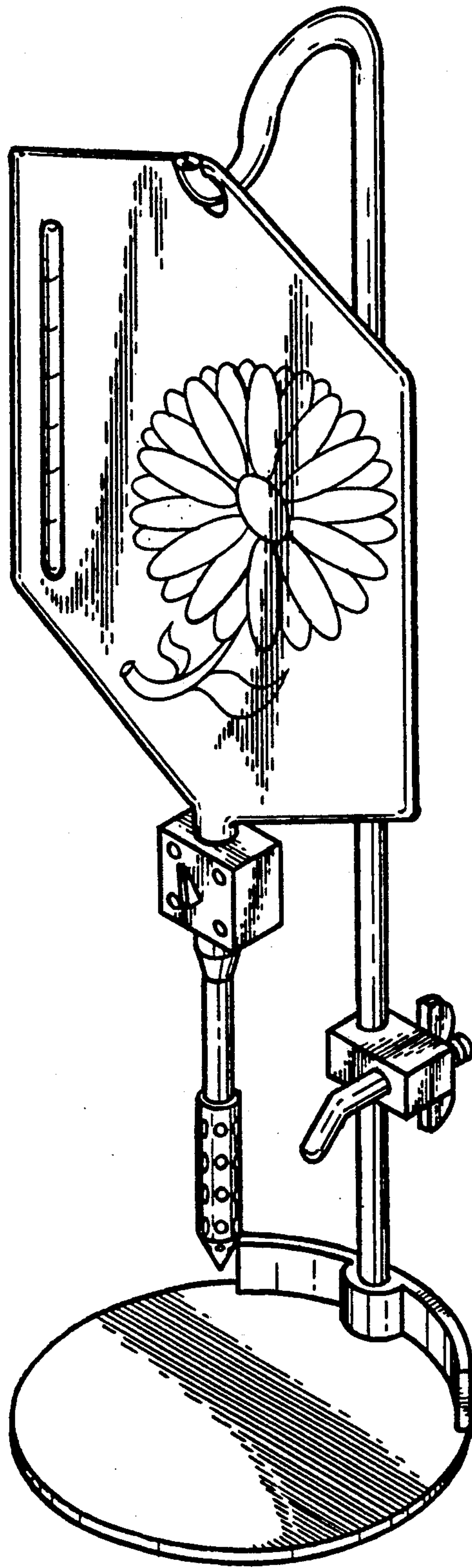

FIG. 1

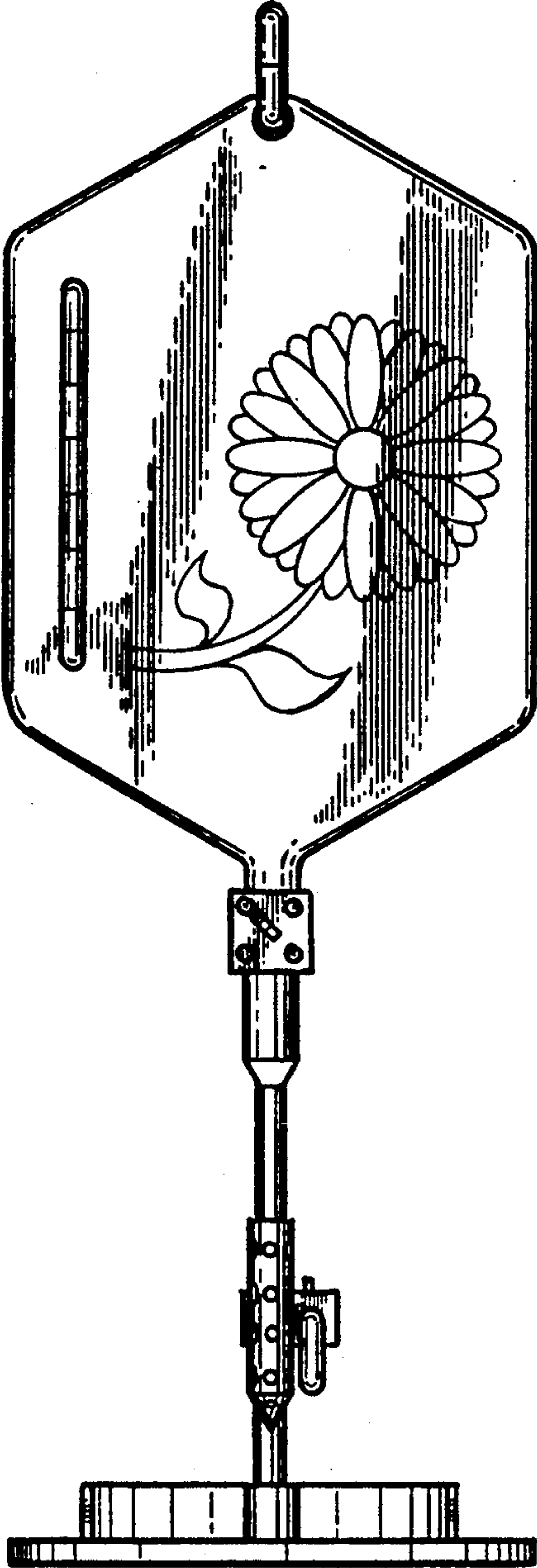

FIG. 2

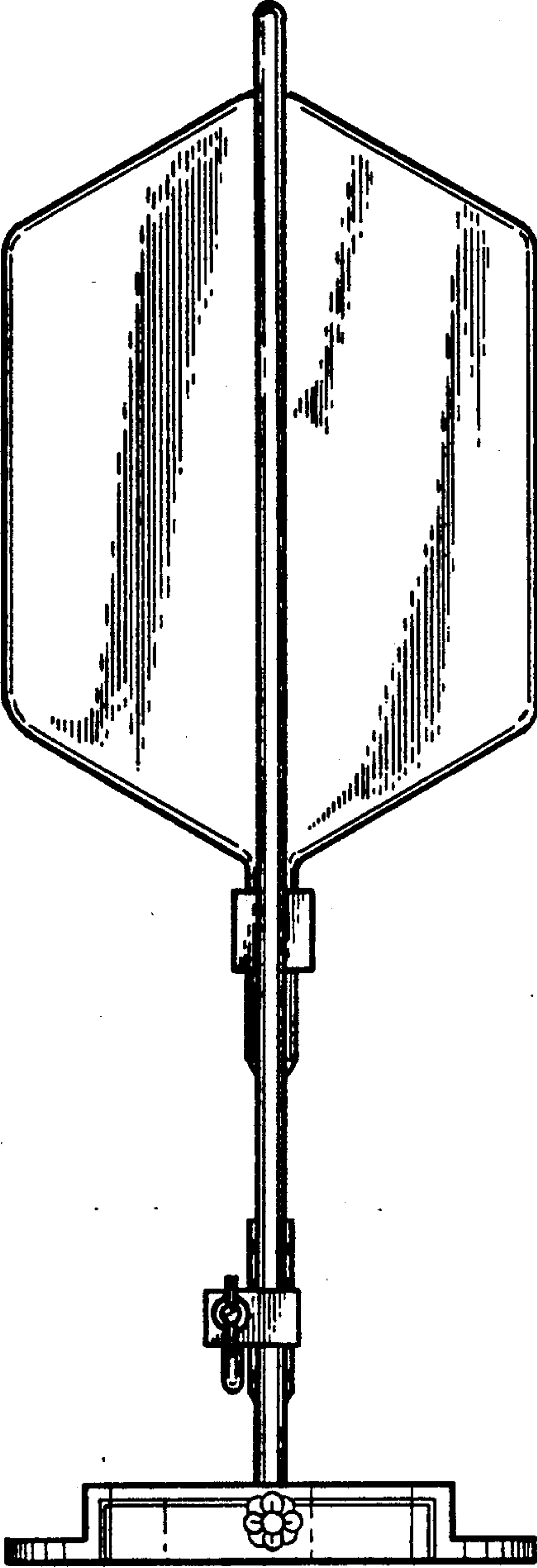

FIG. 3

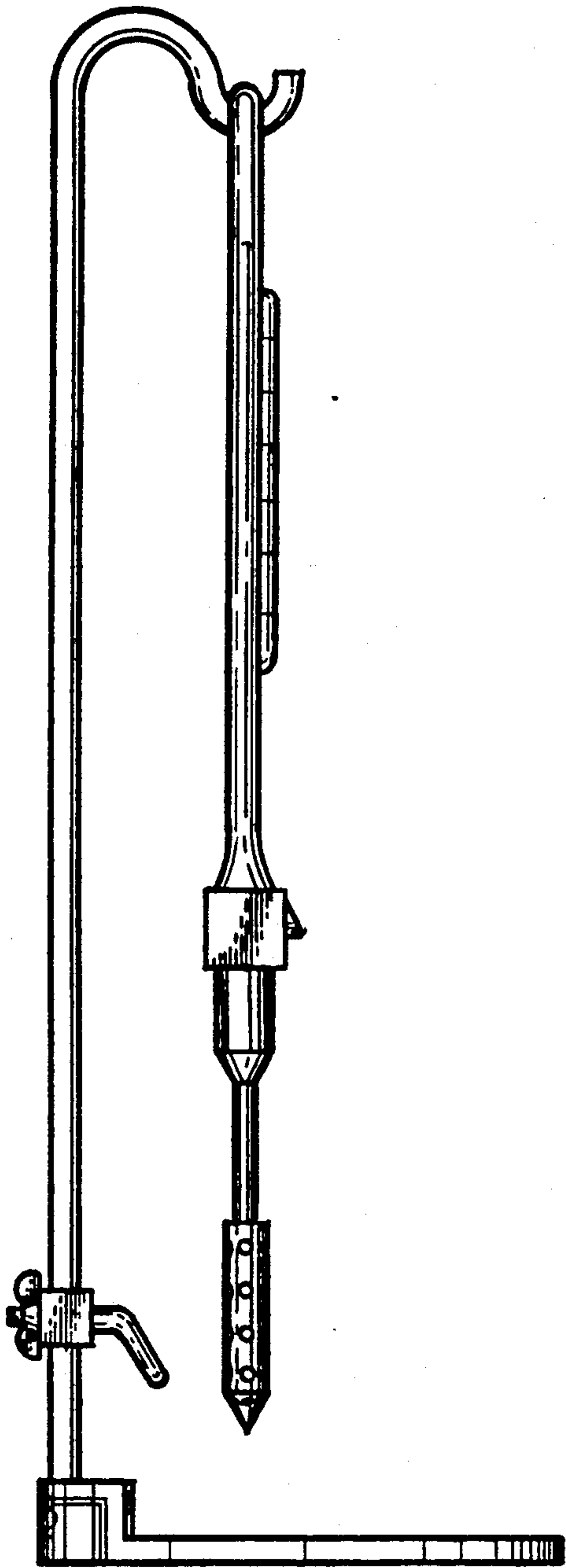

FIG. 4

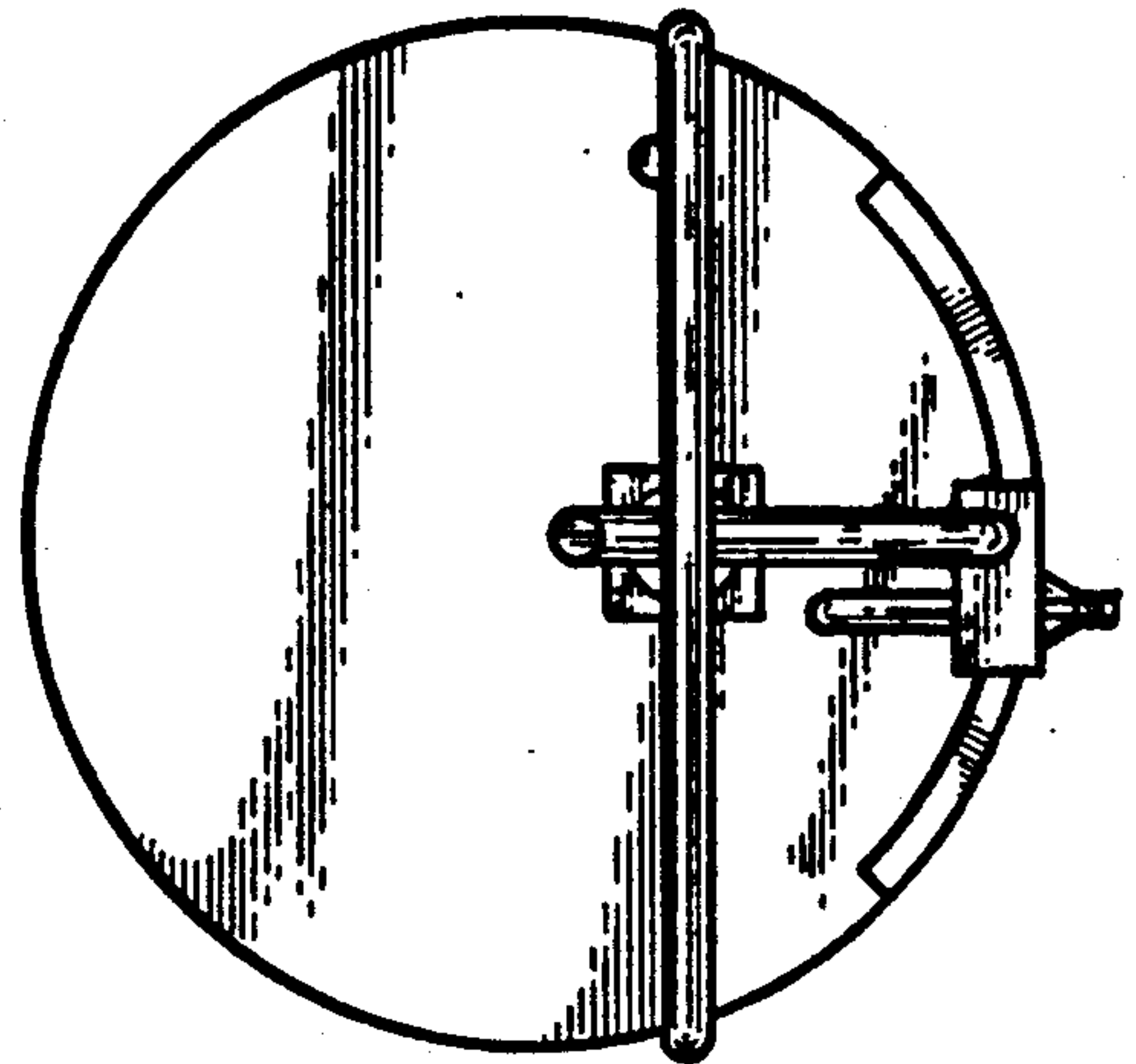

FIG. 5

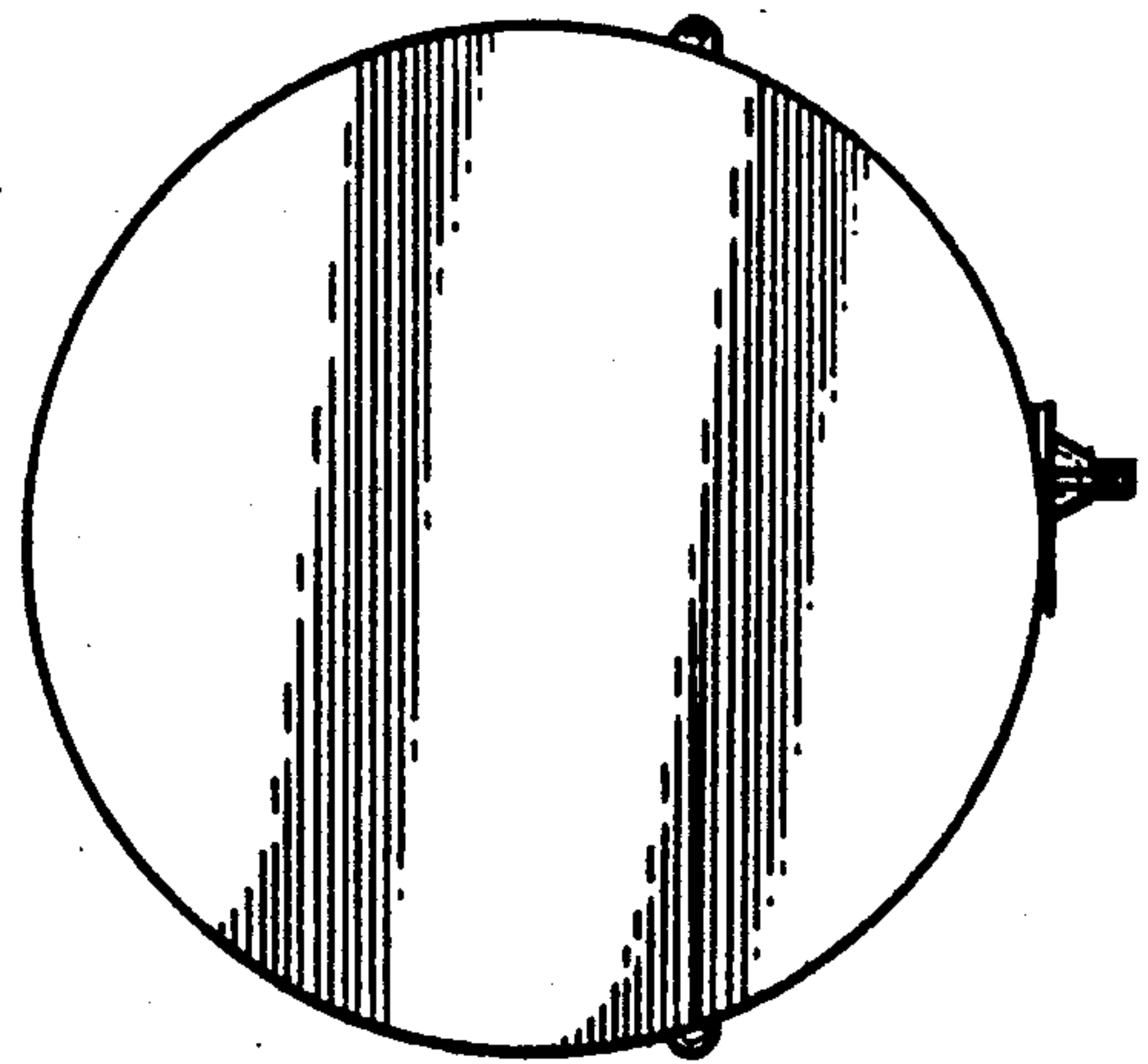

FIG. 6