



US00D333701S

United States Patent [19]

[11] Patent Number: Des. 333,701

Meeks

[45] Date of Patent: \*\* Mar. 2, 1993

[54] FOLDABLE SANITARY TOILET SEAT PROTECTION COVER

Attorney, Agent, or Firm—Staas & Halsey

[76] Inventor: Dormal F. Meeks, 2930 Rustwood, Eustis, Fla. 32726

[57] CLAIM

The ornamental design for a foldable sanitary toilet seat protection cover, as shown and described.

[\*\*] Term: 14 Years

DESCRIPTION

[21] Appl. No.: 608,649

FIG. 1 is a top, right side and front perspective view of a foldable sanitary toilet seat protection cover, showing my new design;

[22] Filed: Nov. 2, 1990

FIG. 2 is a bottom, left side and rear perspective view thereof;

[52] U.S. Cl. .... D23/311; D6/611

FIG. 3 is a top plan view thereof;

[58] Field of Search ..... D6/611; D23/311, 323, D23/313; 4/245.3, 245.4, 245.5, 245.6, 245.7, 245.8; 297/219

FIG. 4 is a bottom plan view thereof;

[56] References Cited

U.S. PATENT DOCUMENTS

D. 233,890	12/1974	Smith	.....	D23/311
1,092,786	4/1914	Troutman	.....	D23/311
1,268,024	5/1918	Levin	.....	4/245.8
1,643,413	9/1927	Mahoney	.....	D23/311
1,720,277	7/1929	Kennedy	.....	4/245.3

FIG. 5 is a left side elevational view thereof;

FIG. 6 is a front elevational view thereof;

FIG. 7 is a right side elevational view thereof;

FIG. 8 is a rear elevational view thereof;

FIG. 9 is an enlarged cross sectional view of a portion of a foldable sanitary toilet seat protection cover, taken along lines 9—9 of FIG. 1;

FOREIGN PATENT DOCUMENTS

3248790	7/1984	Fed. Rep. of Germany	.....	4/245.4
488744	7/1938	United Kingdom	.....	4/245.7

FIG. 10 shows a top, front and right side perspective view thereof in a partially folded condition;

FIG. 11 shows a top, front and right side perspective view thereof in a more folded condition; and,

FIG. 12 shows a top, front and right side perspective view thereof in completely folded and stowable condition.

Primary Examiner—Wallace R. Burke  
Assistant Examiner—Lisa Lichtenstein

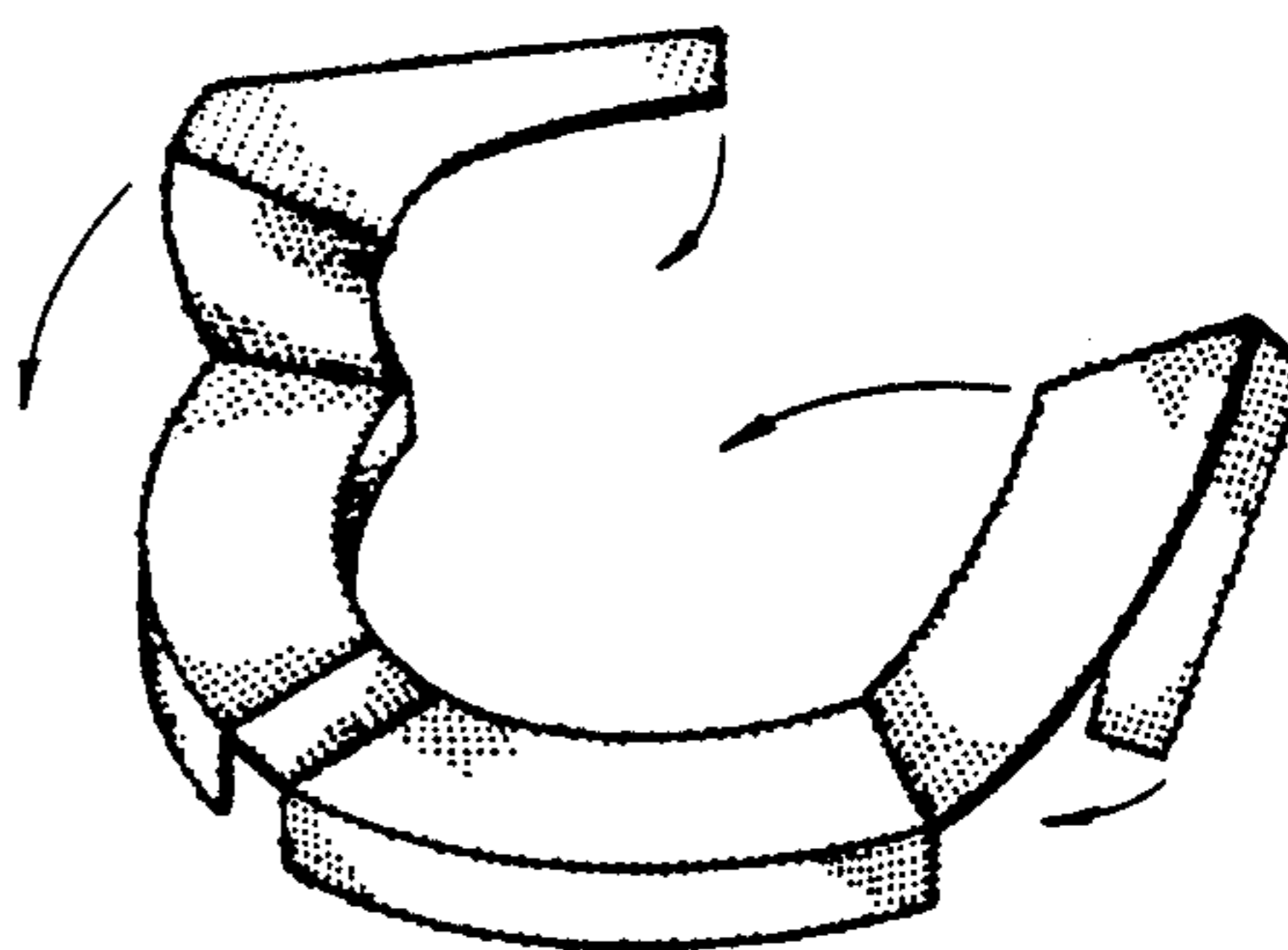
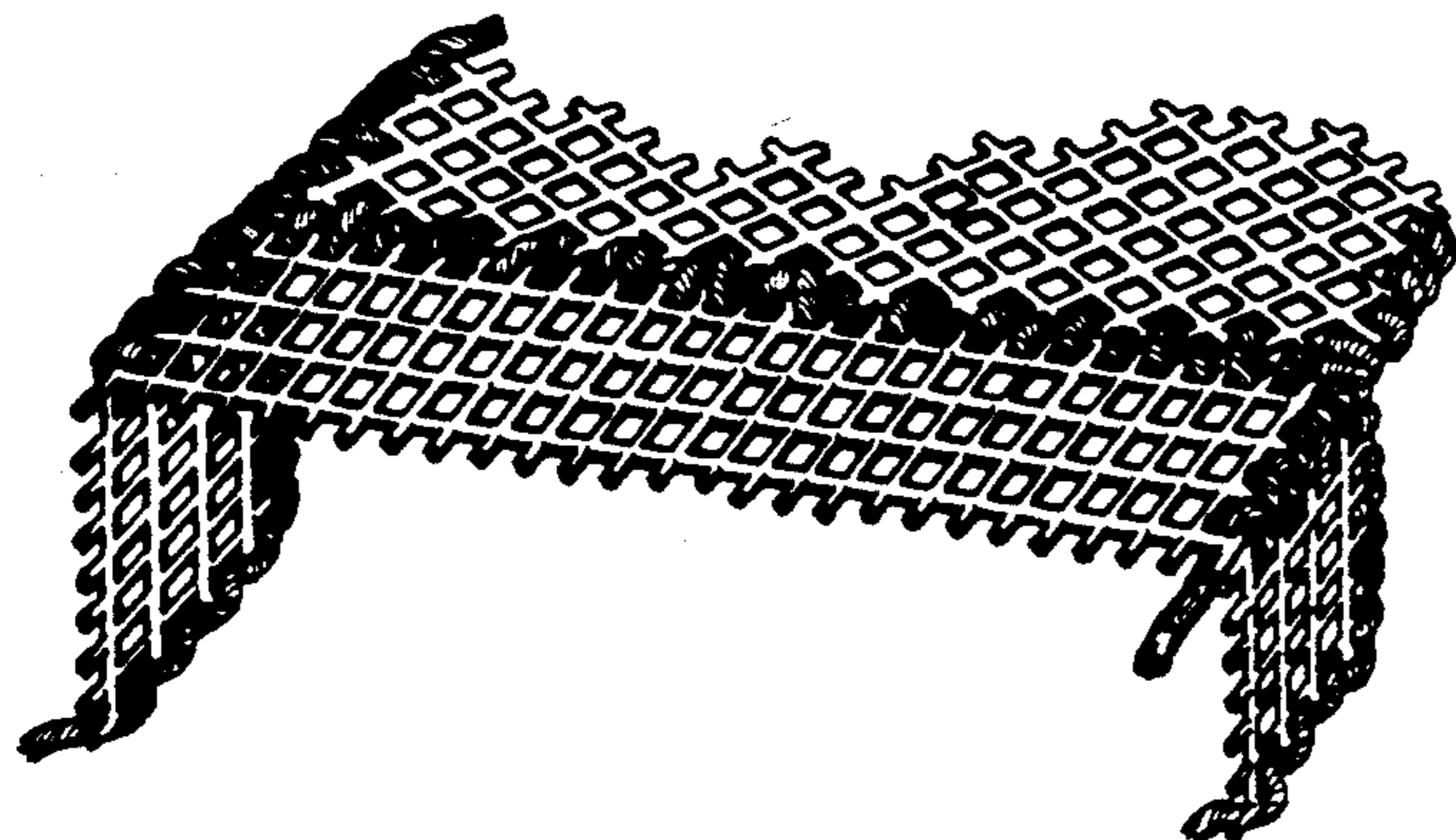
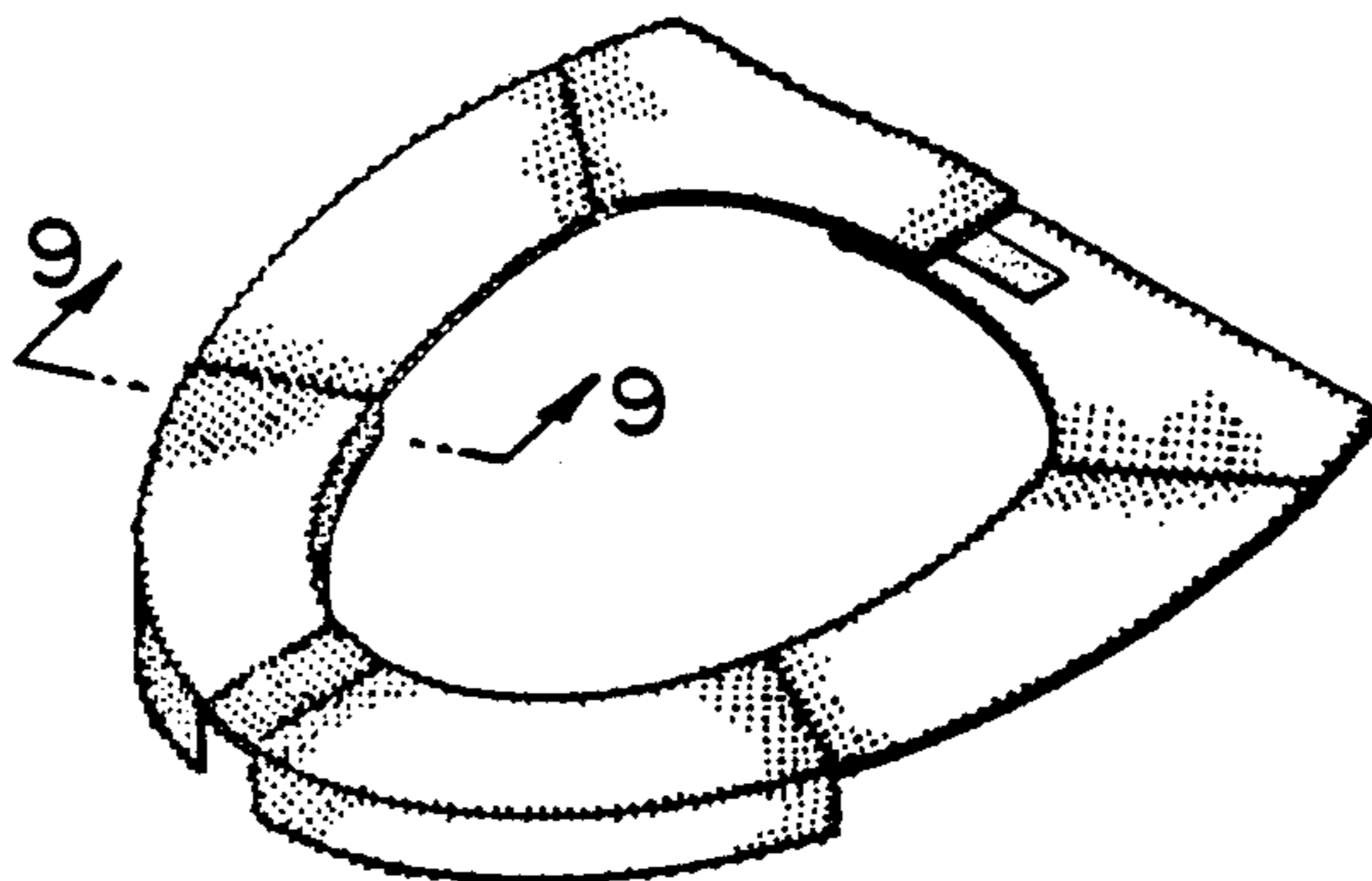

FIG. 1

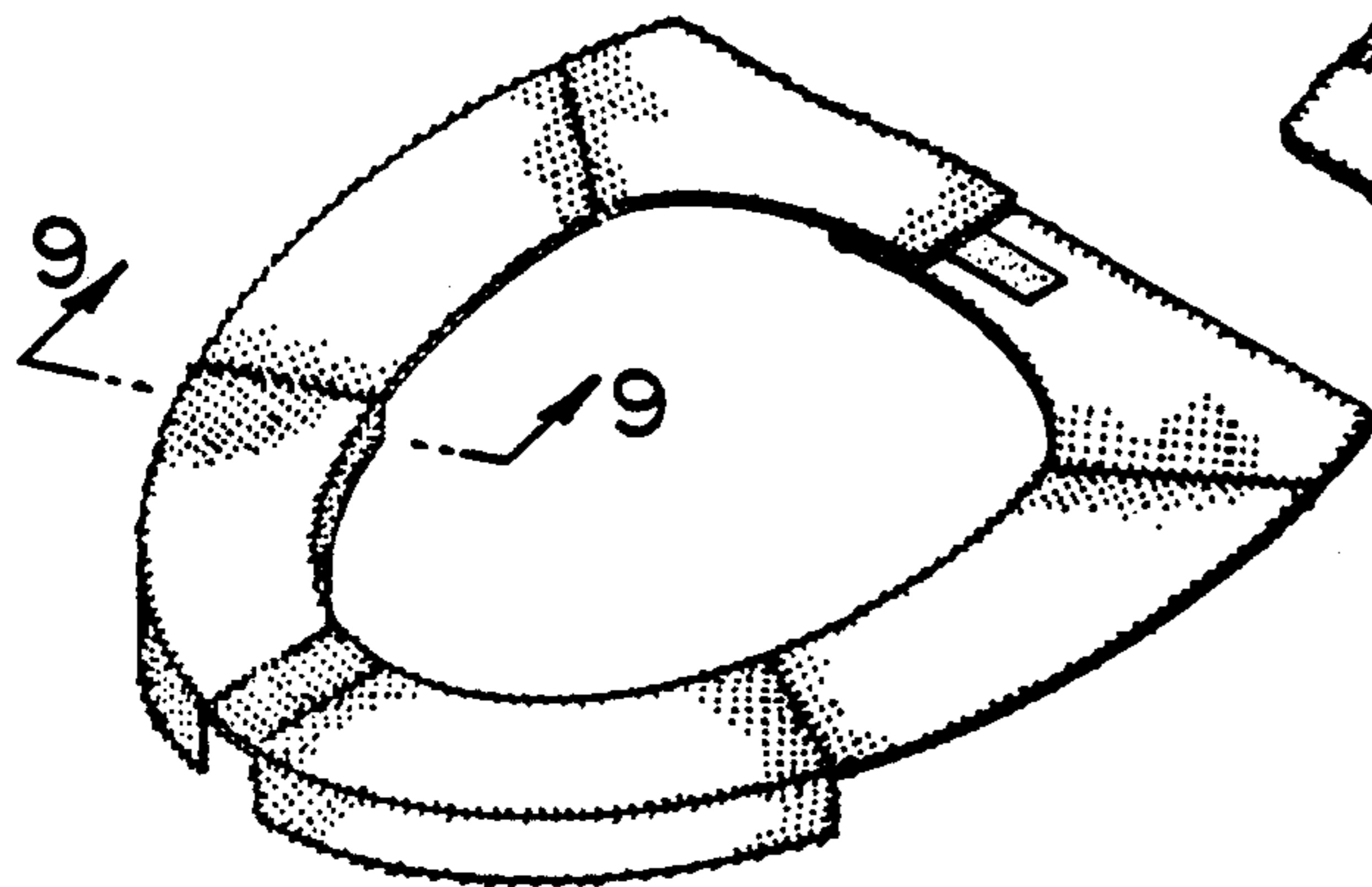

FIG. 2

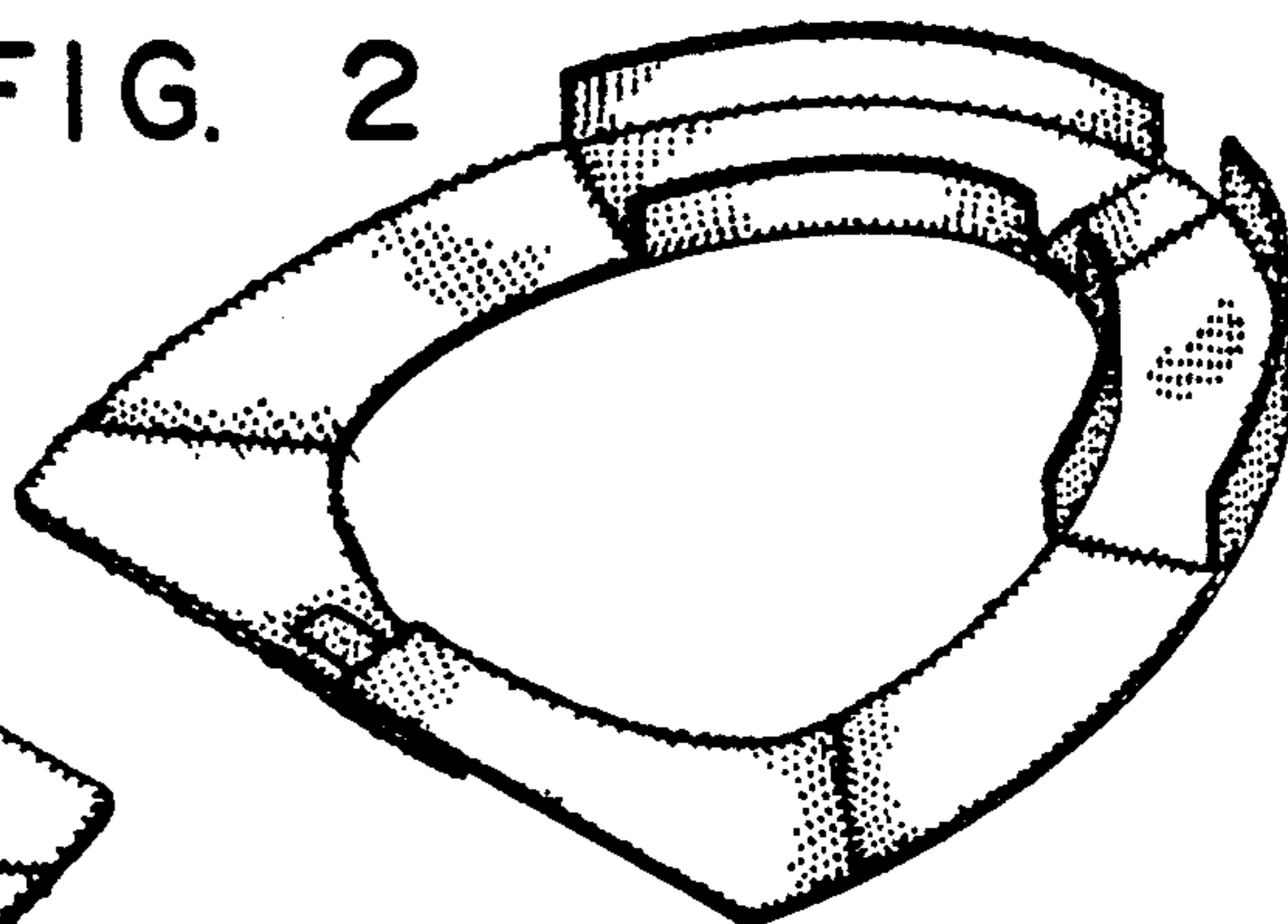

FIG. 3

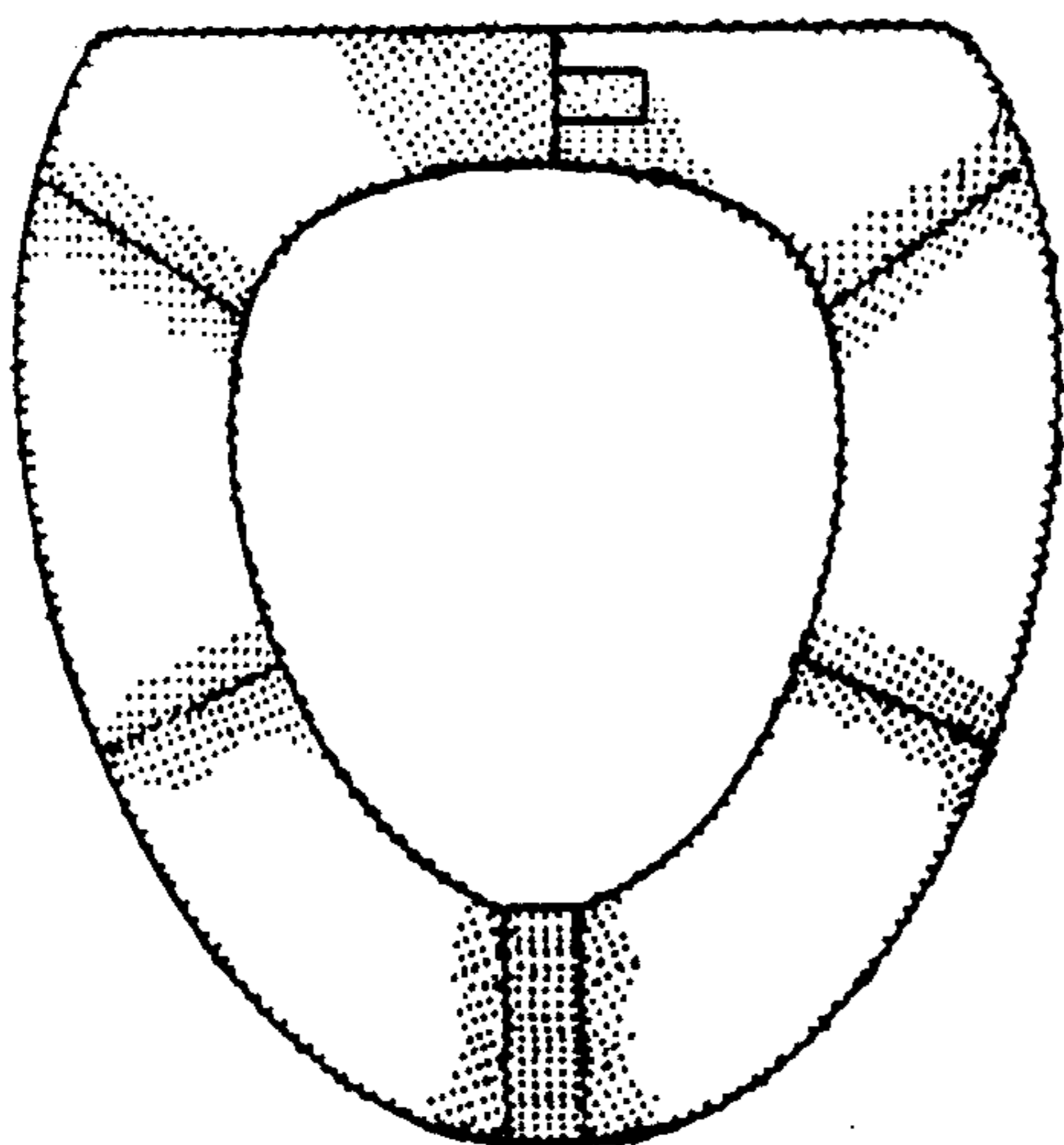

FIG. 4

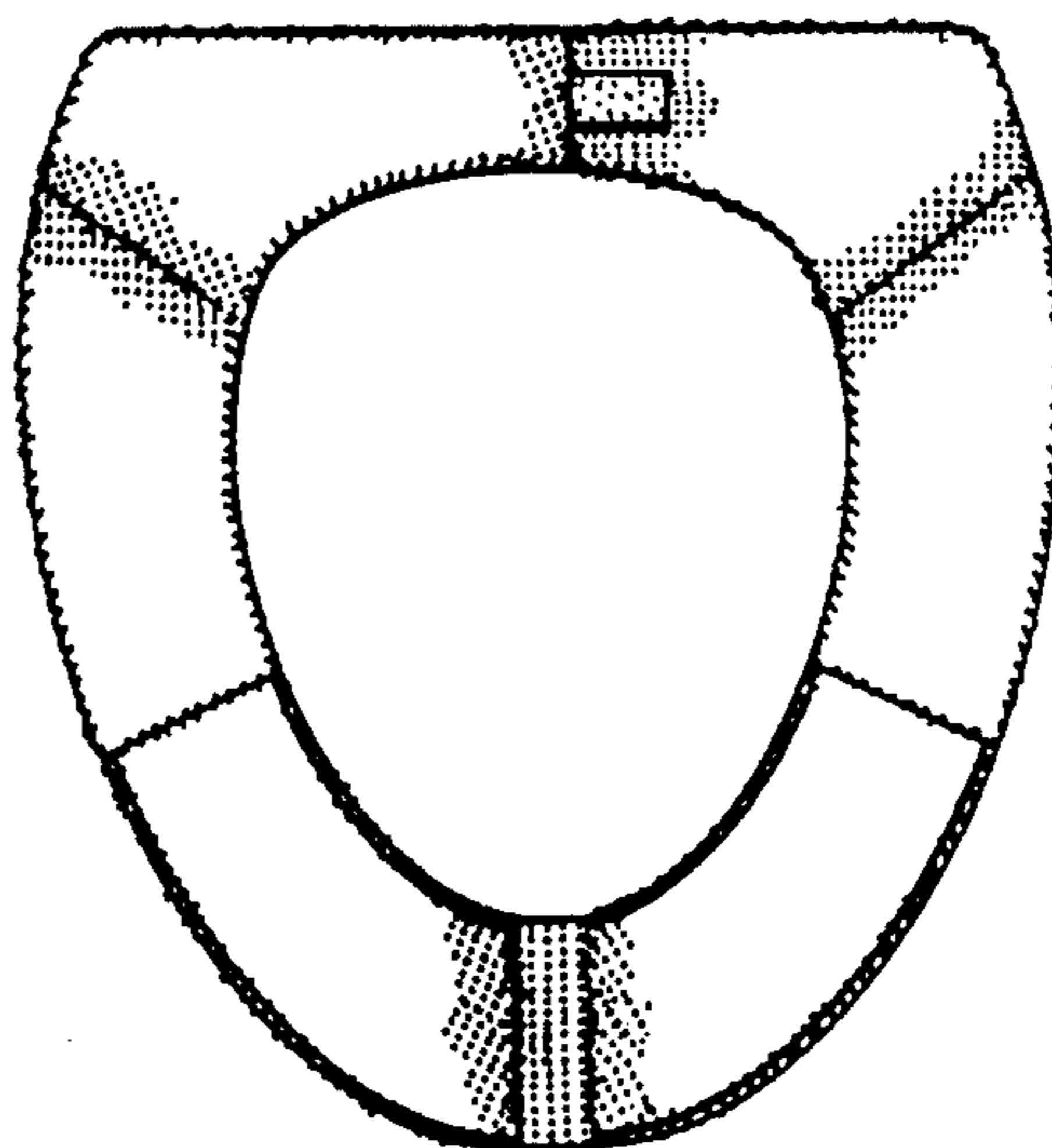

FIG. 5



FIG. 6



FIG. 7



FIG. 8



FIG. 9

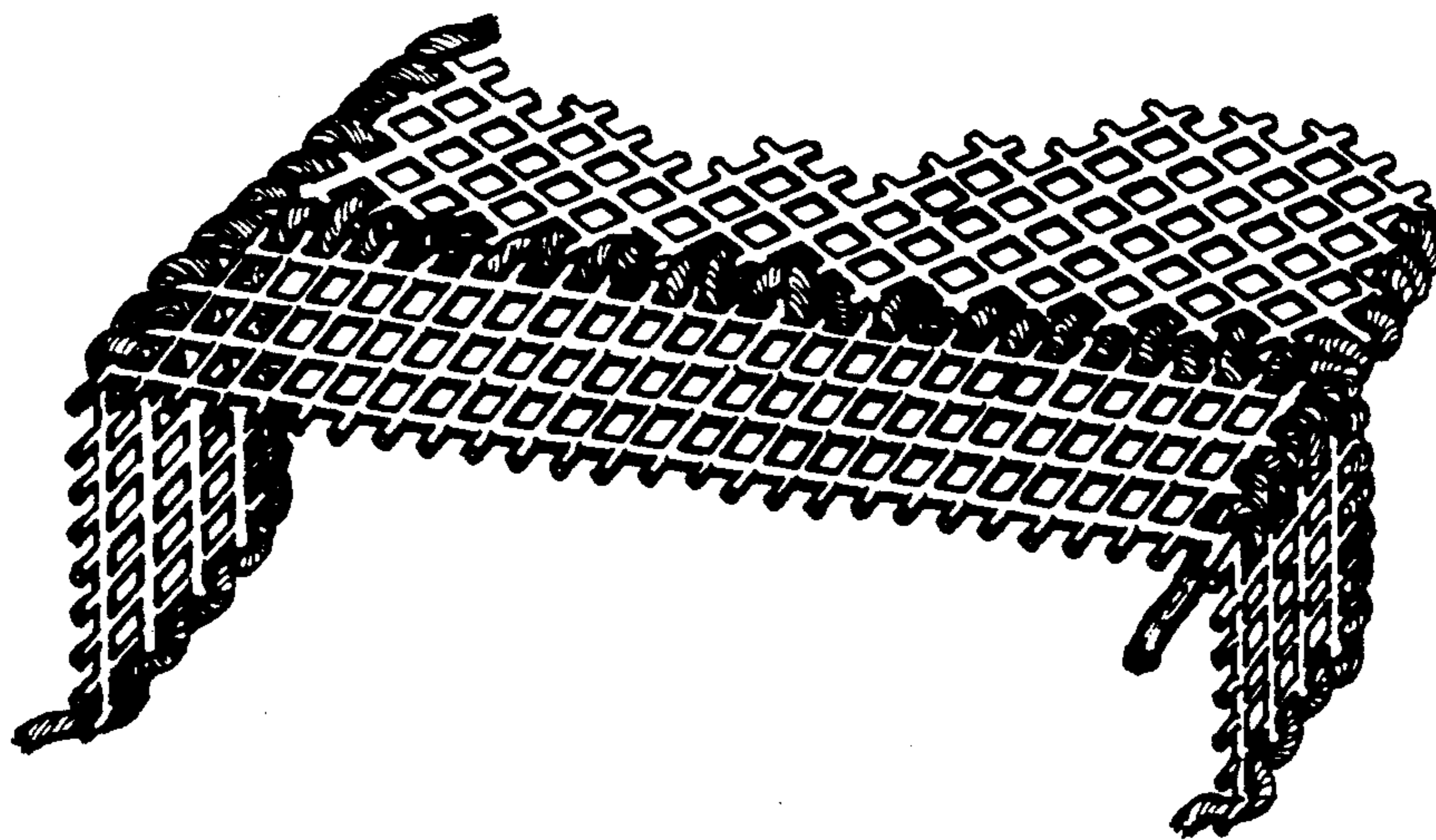



FIG. 10

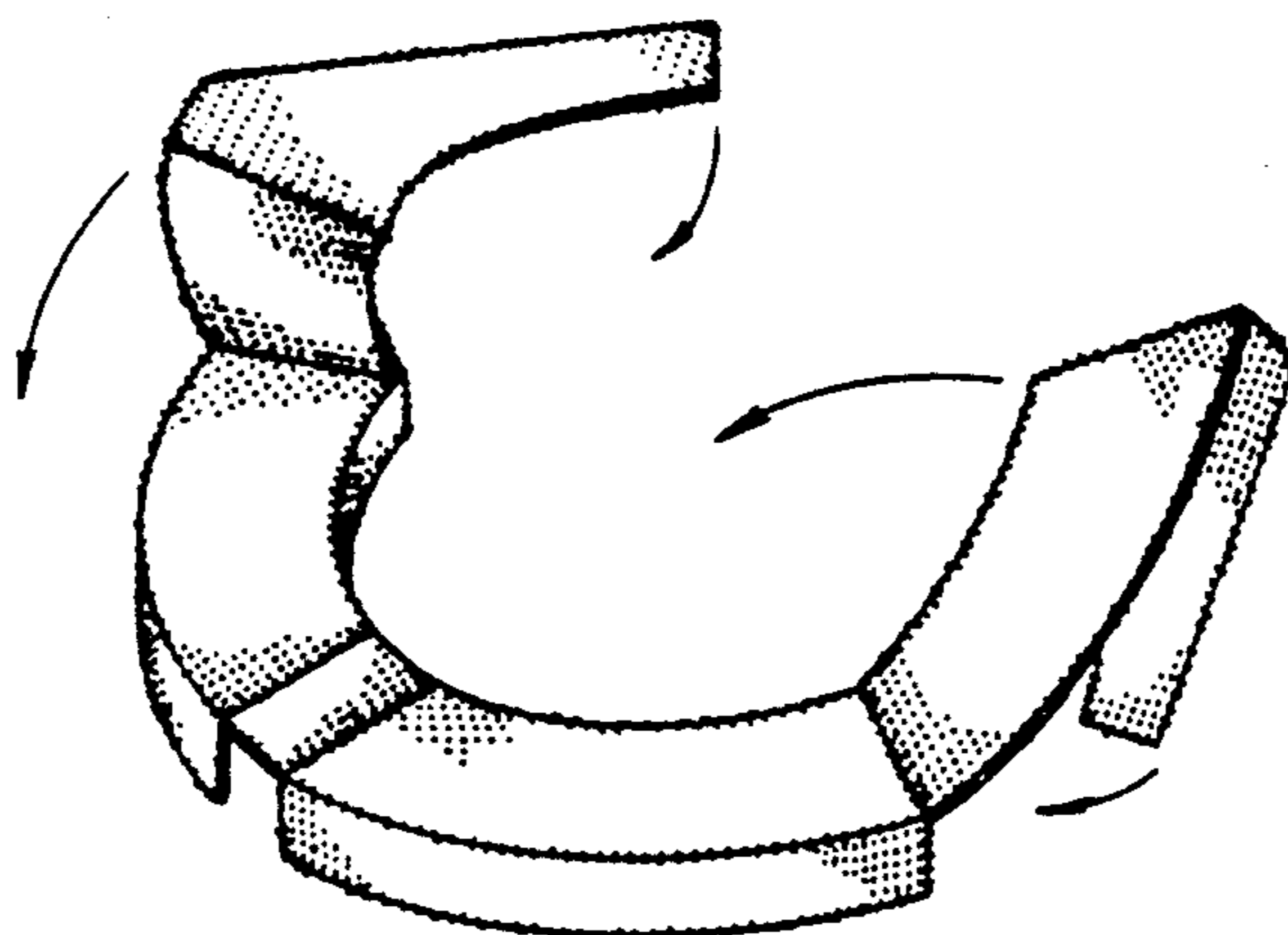

FIG. 11

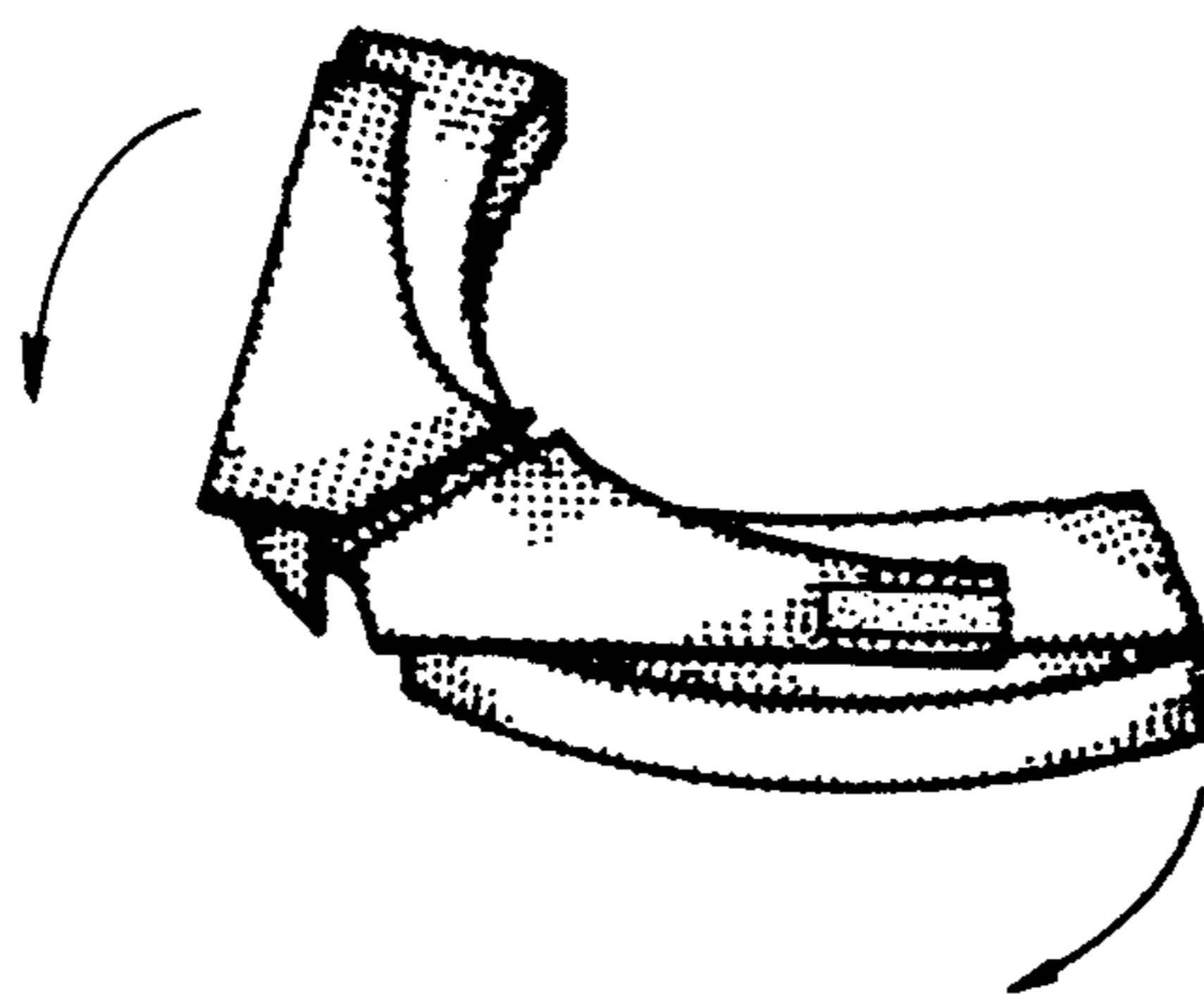

FIG. 12

