



US00D333699S

United States Patent [19]

[11] Patent Number: Des. 333,699

Jacuzzi et al.

[45] Date of Patent: ** Mar. 2, 1993

[54] WHIRLPOOL BATH TUB

[75] Inventors: Roy A. Jacuzzi, Lafayette; Darrell M. Hunger, Berkeley; Ralph D'Innocente, Pittsburg, all of Calif.

[73] Assignee: Jacuzzi Inc., Walnut Creek, Calif.

[**] Term: 14 Years

[21] Appl. No.: 465,875

[22] Filed: Jan. 16, 1990

[52] U.S. Cl. D23/281

[58] Field of Search D23/270, 271, 273, 275-283, D23/303-307; 4/538, 539, 546, 552, 553, 571-573, 578, 579, 589-591, 664, 665; D24/201, 204, 205

[56] References Cited

U.S. PATENT DOCUMENTS

D. 237,183	10/1975	Bonsack	D23/281
D. 247,444	3/1978	Bonsack	D23/275
D. 255,598	6/1980	Chapman	D23/275
D. 271,137	10/1983	Kohler, Jr.	
D. 274,641	7/1984	Griffiths	D23/281
D. 305,063	12/1989	Jacuzzi et al.	D24/205
1,940,514	12/1933	Steinkamp	4/590

OTHER PUBLICATIONS

Domestic Engineering, Jul. 1989, p. 69, "Bath with Waterfall" item.

Hydromassage Jacuzzi C'Est Tellement Mieux, sales brochure, 1988.

Americh Corp. sales brochure: "Introducing Our Whirlpool Bath Tub Collection", 1984, p. 1.

Primary Examiner—James R. Largen

Attorney, Agent, or Firm—Limbach & Limbach

[57] CLAIM

The ornamental design for a whirlpool bath tub, as shown and described.

DESCRIPTION

FIG. 1 is a top front perspective view of a whirlpool bathtub showing our new design;

FIG. 2 is a top plan view of a second embodiment thereof, the second embodiment differs from the first only in the omission of the skirt therefrom;

FIG. 3 is a cross-sectional view taken on line 3—3 of FIG. 2;

FIG. 4 is a cross-sectional view taken on line 4—4 of FIG. 2;

FIG. 5 is a cross-sectional view taken on line 5—5 of FIG. 2; and,

FIG. 6 is a cross-sectional view taken on line 6—6 of FIG. 2.

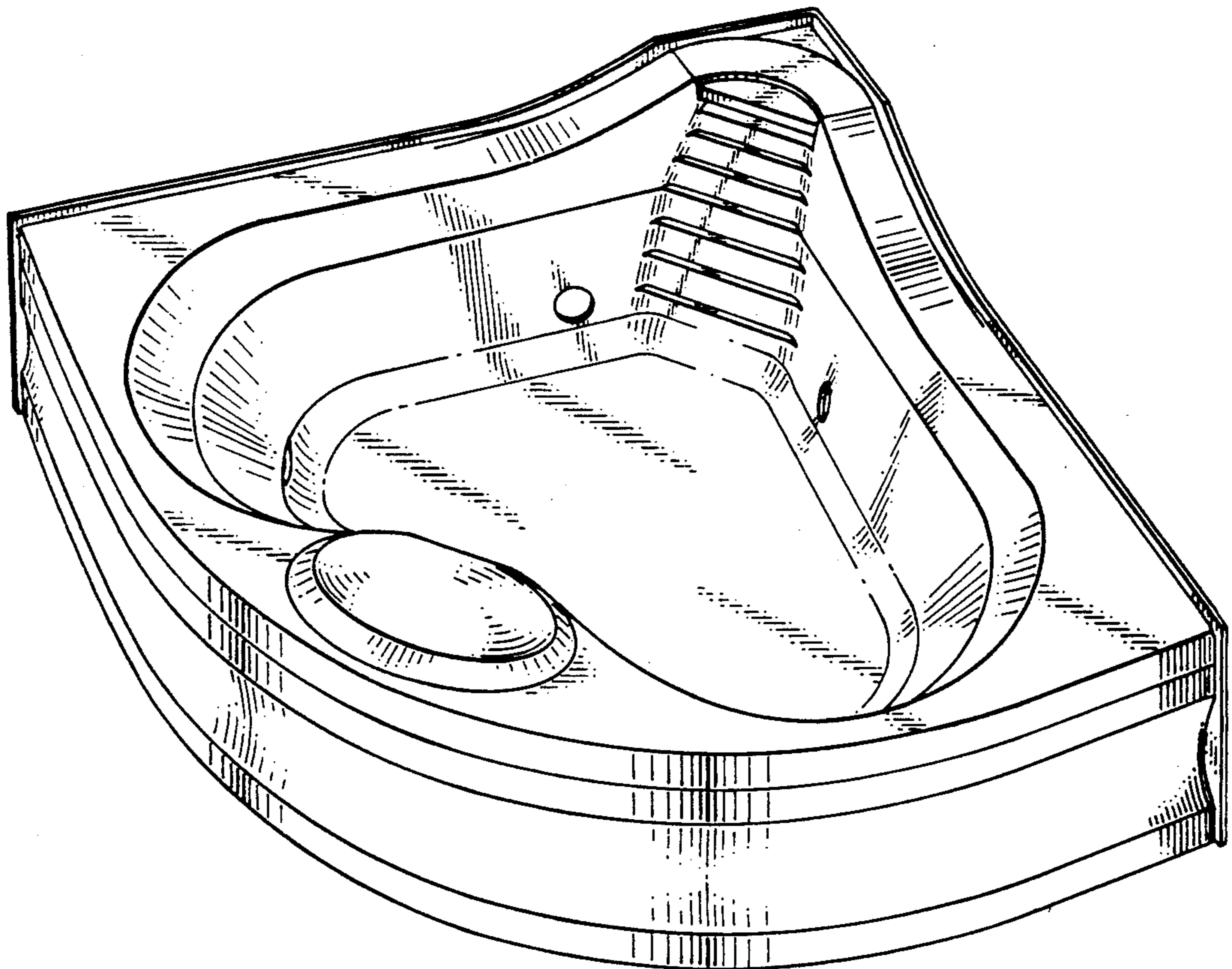

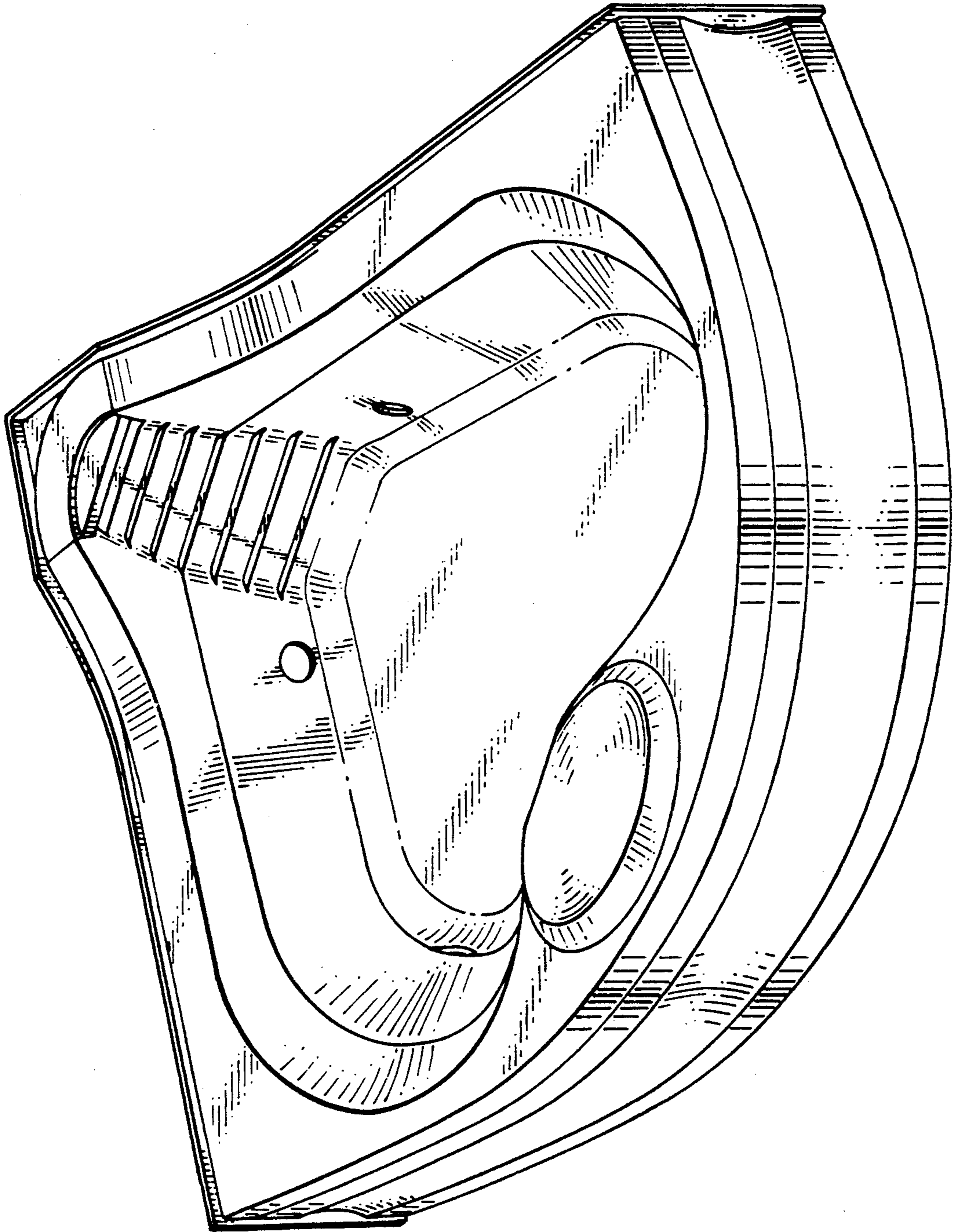

FIG. 1.

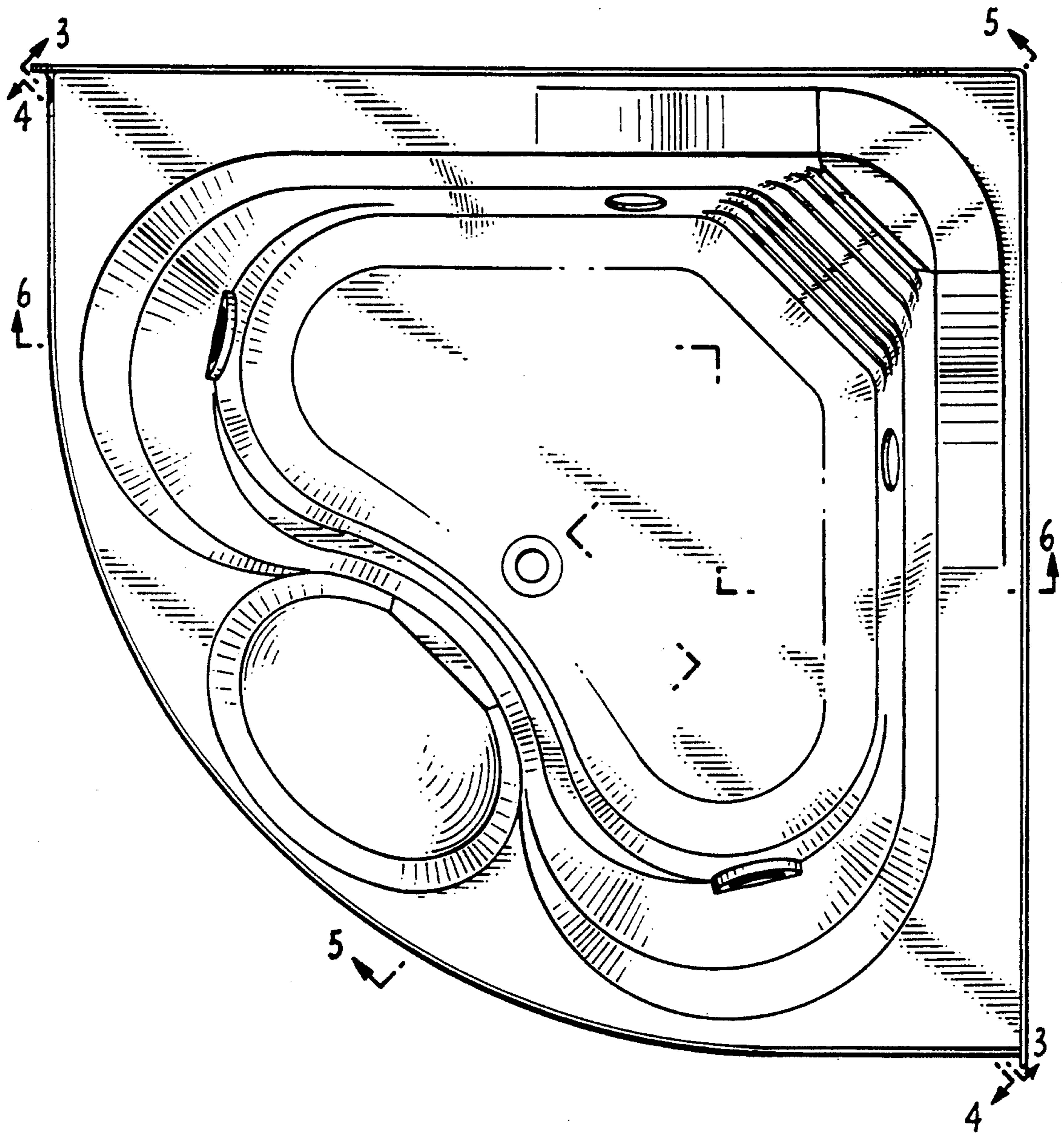

FIG. 2.

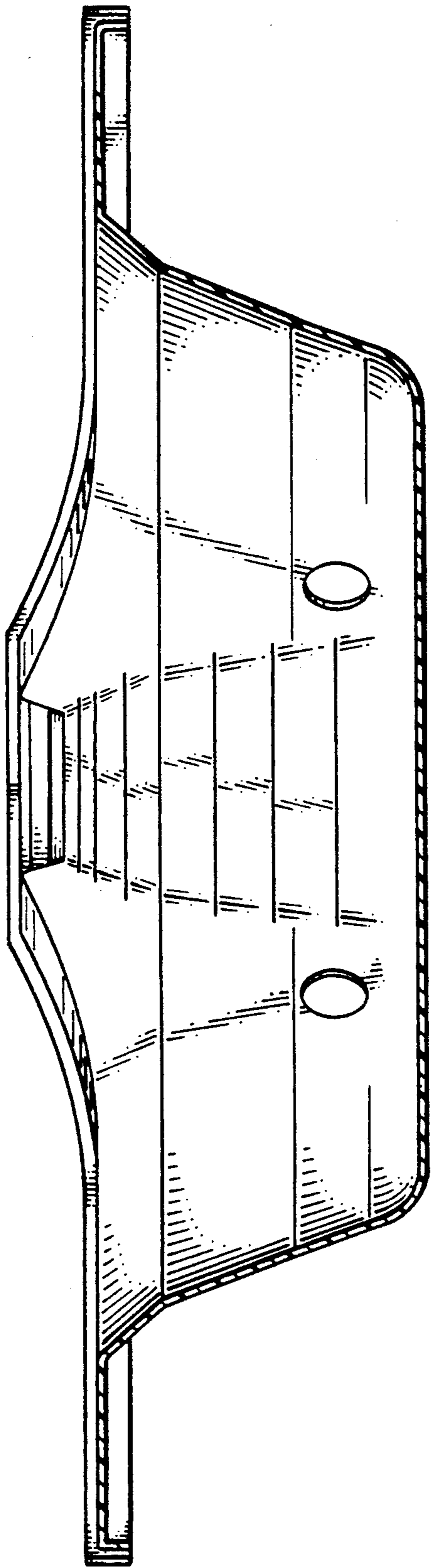

FIG. 3.

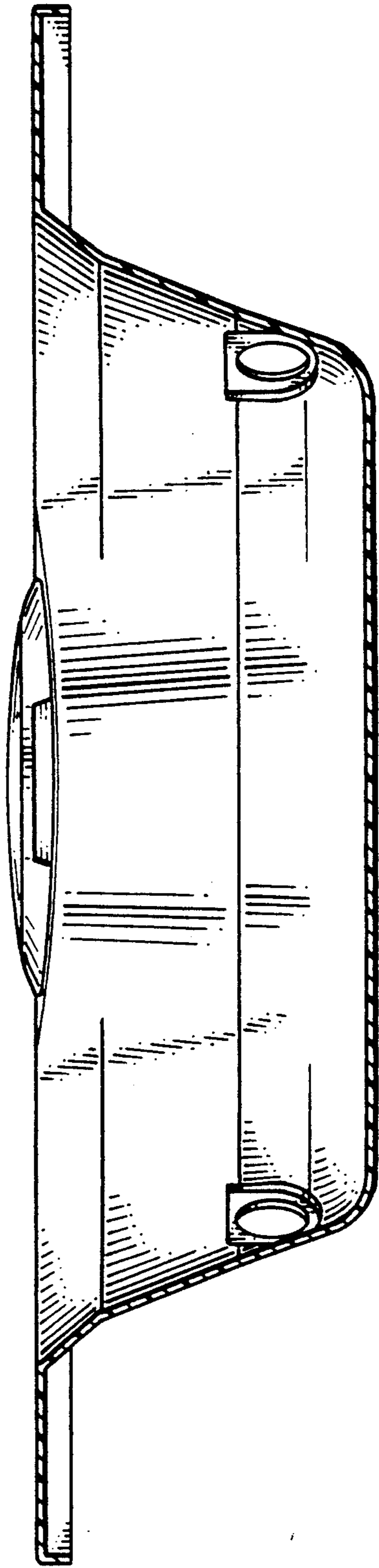

FIG. 4

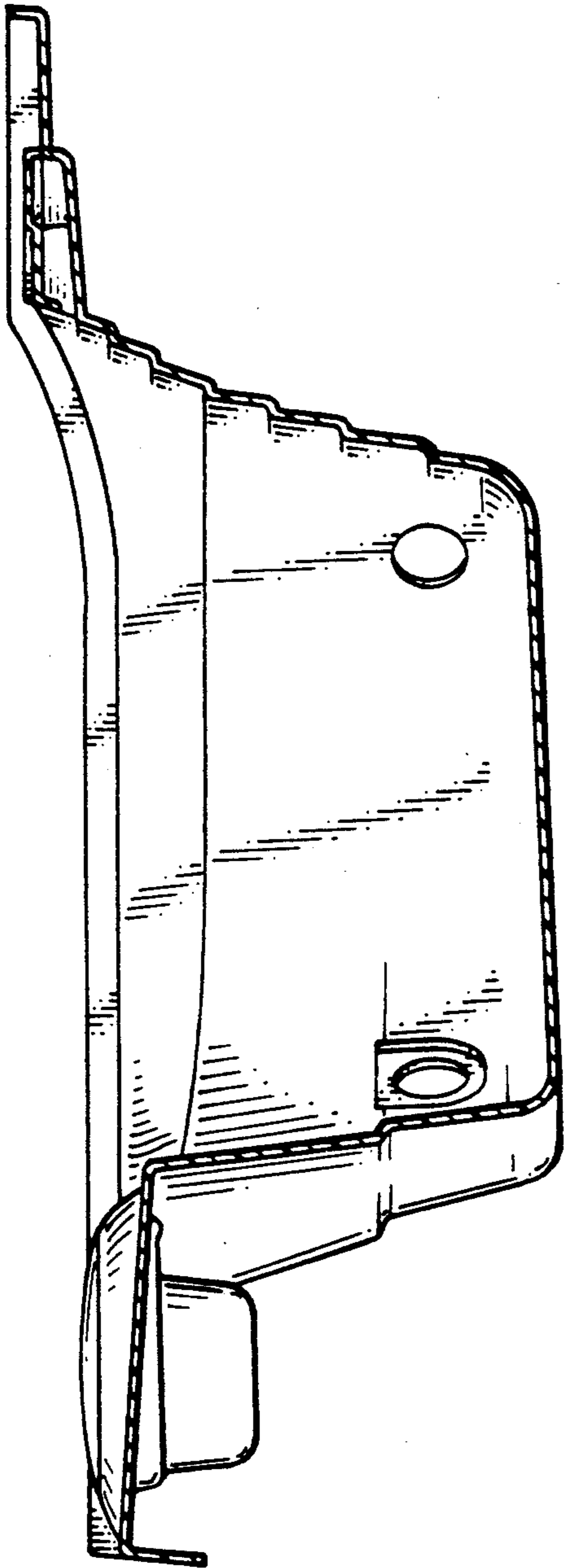

FIG. 5

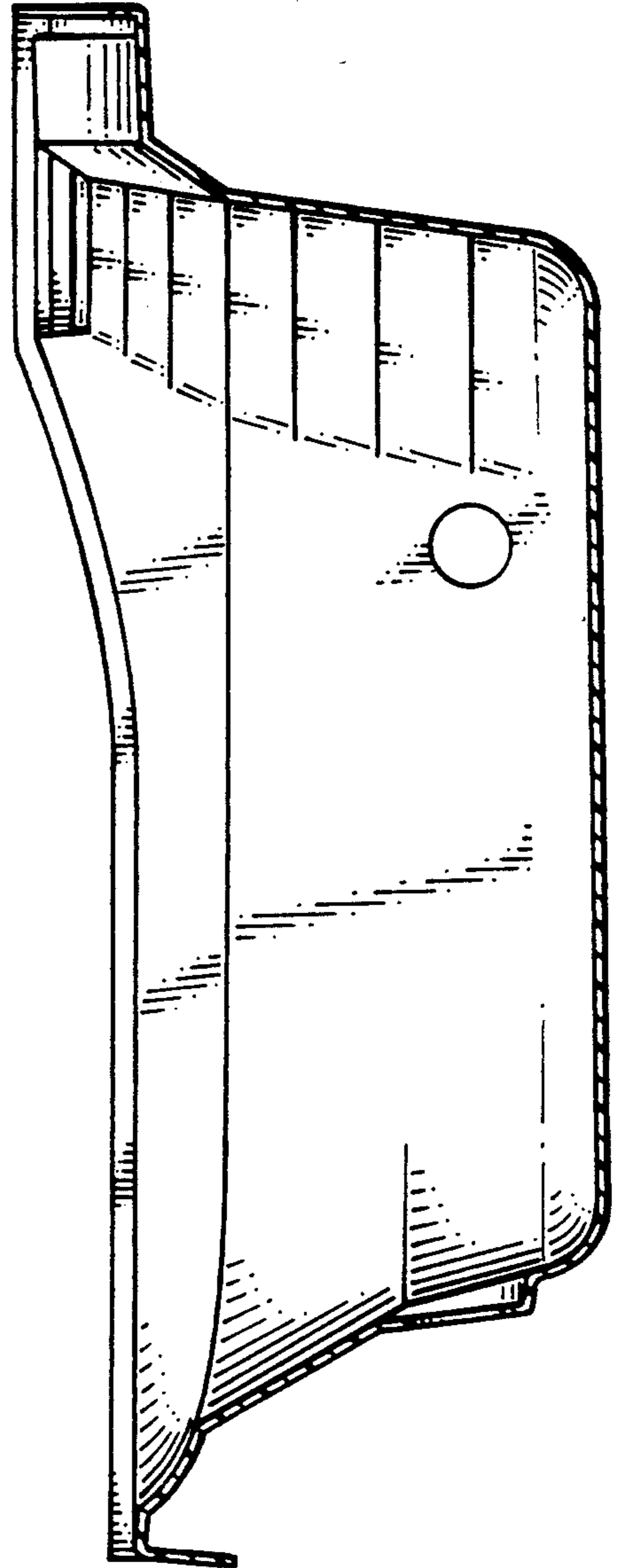

FIG. 6