



US00D333666S

United States Patent [19]

[11] Patent Number: **Des. 333,666**

Kawashima et al.

[45] Date of Patent: **** Mar. 2, 1993**

[54] **POSITIONING ACTUATOR**

[75] Inventors: **Sousuke Kawashima; Toshiyuki Onizuka**, both of Gumma, Japan

[73] Assignee: **Nippon Seiko Kabushiki Kaisha**, Tokyo, Japan

[**] Term: **14 Years**

[21] Appl. No.: **662,882**

[22] Filed: **Mar. 1, 1991**

[52] U.S. Cl. **D15/142; D15/199**

[58] Field of Search **D15/139, 140, 141, 142, D15/199; 73/118.1; 74/89.15, 425, 665 GD, 625; 91/48, 64, 94, 980, 131, 392; 185/40 R; 251/69; 360/104, 105**

[56] **References Cited**

U.S. PATENT DOCUMENTS

D. 207,458 4/1967 Doolittle D15/138

D. 264,089 4/1982 Reid et al. D15/199
4,627,300 12/1986 Stoy 74/89.15
4,719,816 1/1988 Carlñas 74/625

Primary Examiner—Alan P. Douglas
Assistant Examiner—Antoine D. Davis
Attorney, Agent, or Firm—Wegner, Cantor, Mueller & Player

[57] **CLAIM**

The ornamental design for positioning actuator, as shown and described.

DESCRIPTION

FIG. 1 is a perspective view of a positioning actuator showing our new design;
FIG. 2 is a top plan view thereof;
FIG. 3 is a front elevational view thereof;
FIG. 4 is a bottom plan view thereof;
FIG. 5 is a rear elevational view thereof;
FIG. 6 is a left side elevational view thereof; and,
FIG. 7 is a right side elevational view thereof.

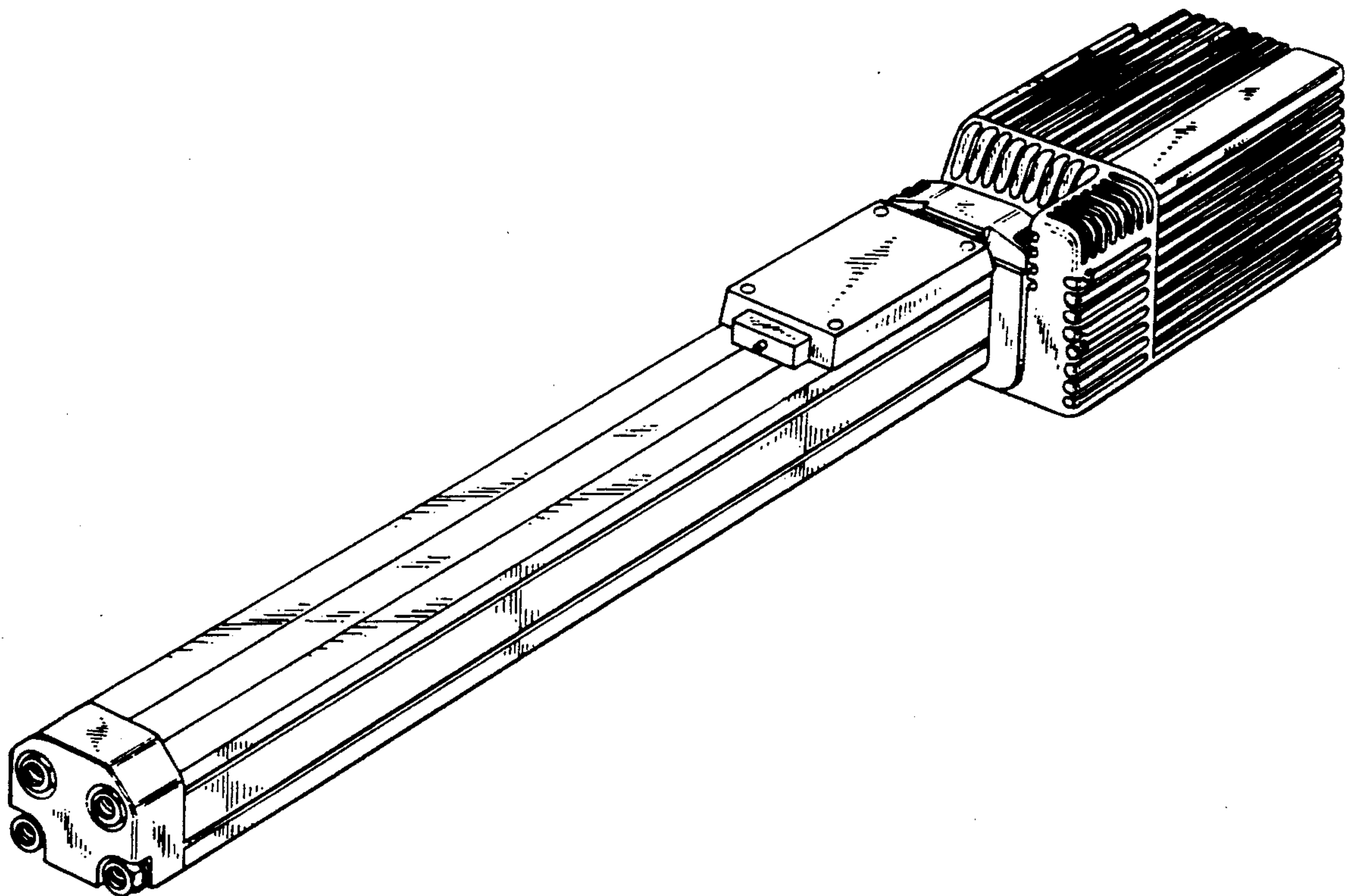

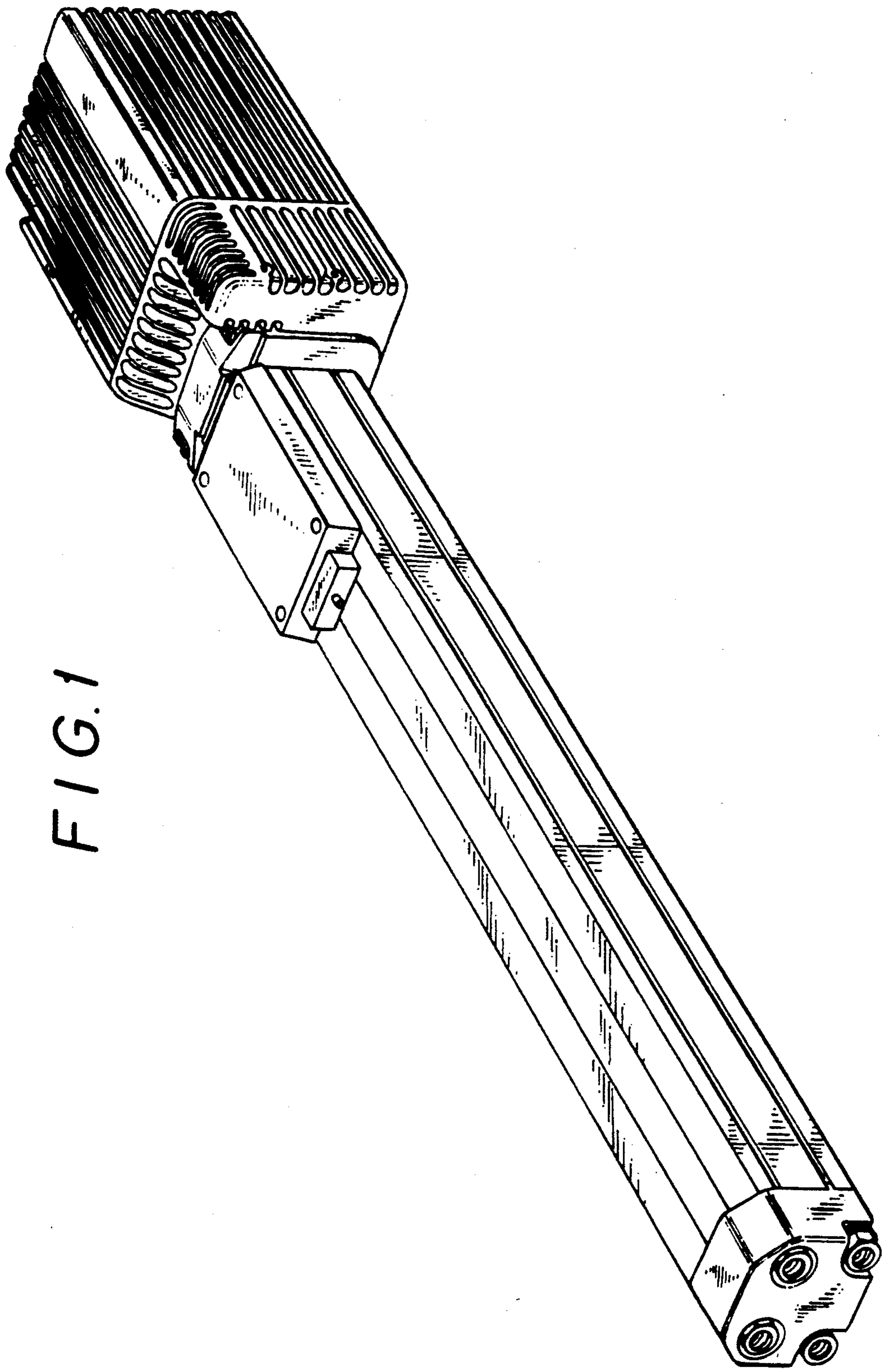

FIG. 1

FIG. 2

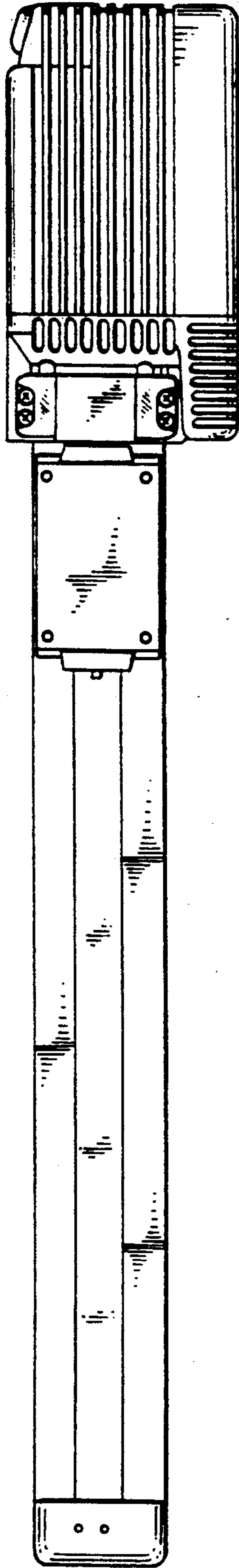

FIG. 3

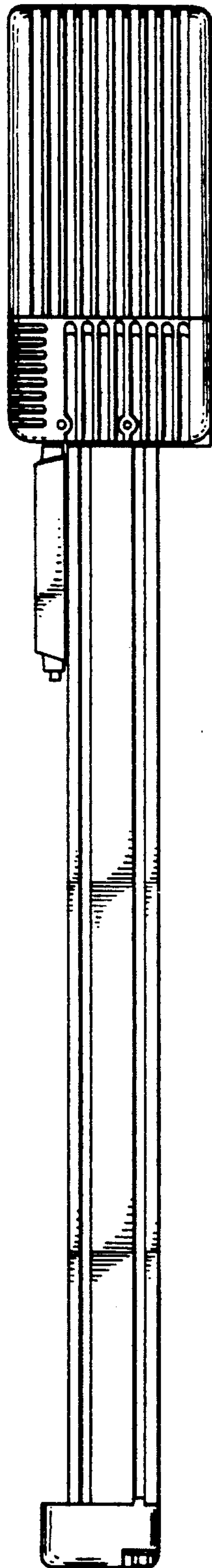

FIG. 4

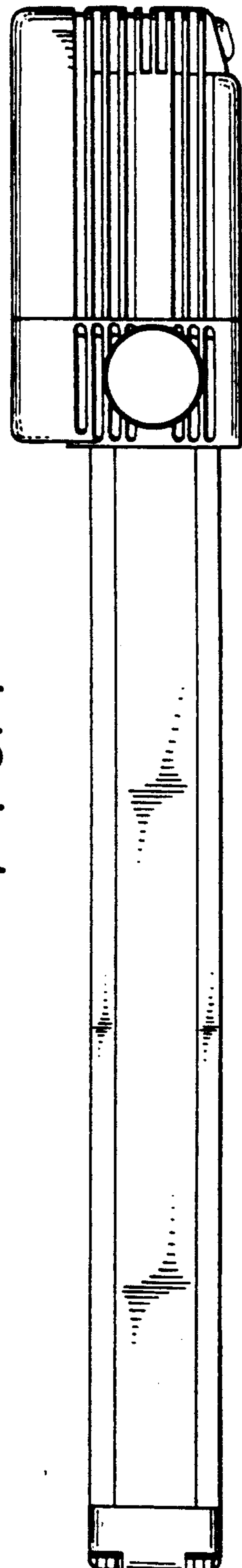

FIG. 5

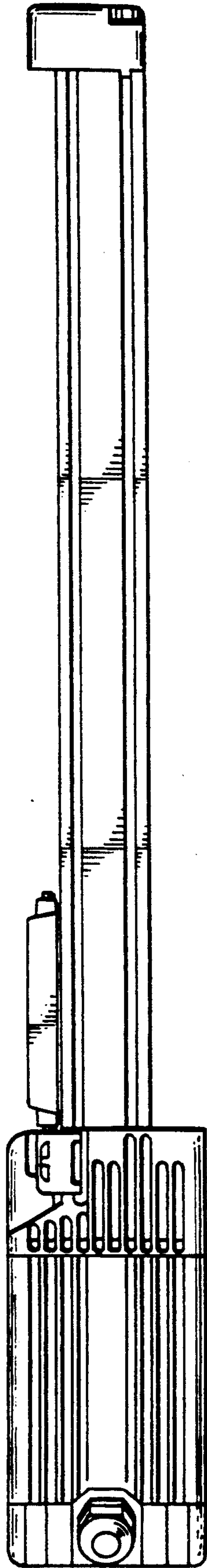

FIG. 6

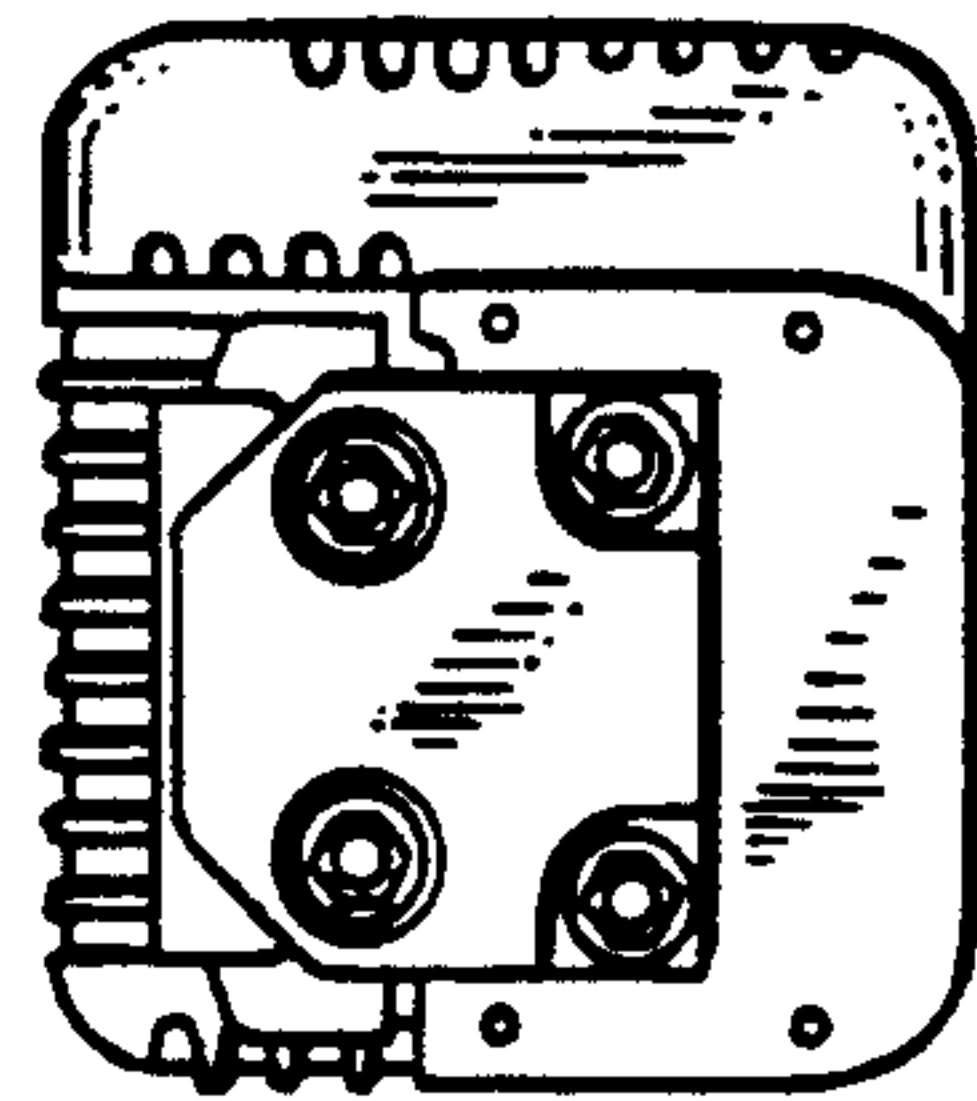

FIG. 7

