



US00D333591S

# United States Patent [19]

[11] Patent Number: Des. 333,591

Gradecki et al.

[45] Date of Patent: \*\* Mar. 2, 1993

[54] MUG

[75] Inventors: **Raymond J. Gradecki, Mundelein; Gerald R. Sorensen, Elgin; Steven Holt, Des Plaines, all of Ill.**

[73] Assignee: **NCM International, Inc., Arlington Heights, Ill.**

[\*\*] Term: **14 Years**

[21] Appl. No.: **710,299**

[22] Filed: **Jun. 4, 1991**

[52] U.S. Cl. .... **D7/514; D7/536**

[58] Field of Search ..... **D7/509, 507, 510, 514, D7/511, 519, 523, 525, 526, 527, 528, 529, 530, 531, 532, 533, 536; 220/74 A, 428, 24, 12, 675, 669**

D. 191,464	10/1961	Skupien .....	D7/515
D. 253,385	11/1979	Reyda .....	D7/515
D. 261,085	10/1981	Ventura .....	D7/509
D. 326,209	5/1992	Unger .....	D7/536
2,372,872	4/1945	Wolper .....	D7/536 X
4,928,412	5/1990	Nishiyama .....	D7/507 X

*Primary Examiner*—Alan P. Douglas  
*Assistant Examiner*—M. N. Pandozzi  
*Attorney, Agent, or Firm*—Wallenstein, Wagner & Hattis, Ltd.

### [57] CLAIM

The ornamental design for a mug, as shown and described.

### DESCRIPTION

FIG. 1 is a top left perspective view of a mug showing our new design;  
FIG. 2 is a left side elevational view thereof;  
FIG. 3 is a front elevational view thereof;  
FIG. 4 is a right side elevational view thereof;  
FIG. 5 is a rear elevational view thereof;  
FIG. 6 is a top plan view thereof; and,  
FIG. 7 is a bottom plan view thereof.

### [56] References Cited

#### U.S. PATENT DOCUMENTS

D. 170,666	10/1953	Stenger .....	D7/523
D. 181,919	1/1958	Arens .....	D9/392
D. 183,764	10/1958	Noble .....	D7/515

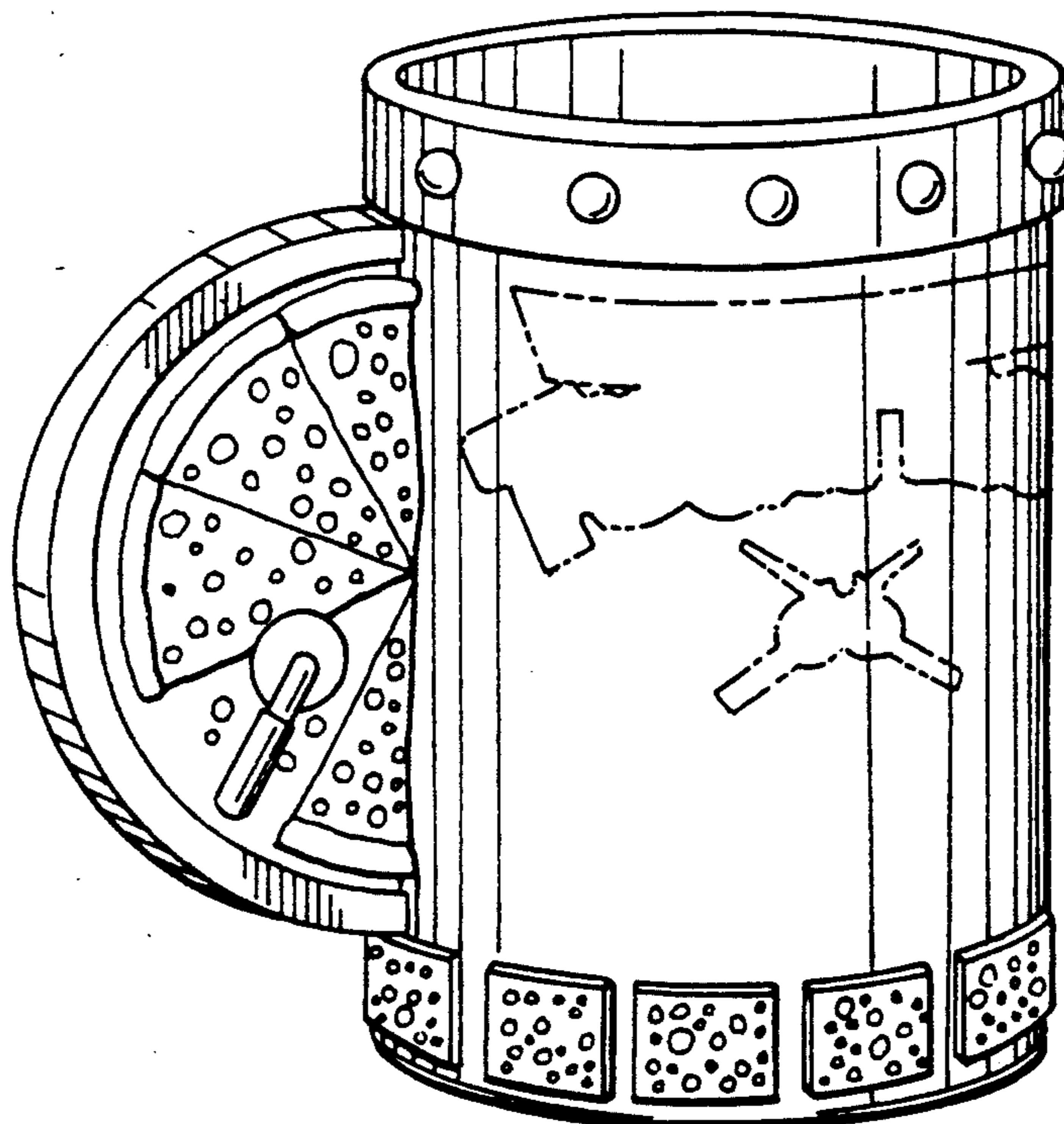

FIG. 1

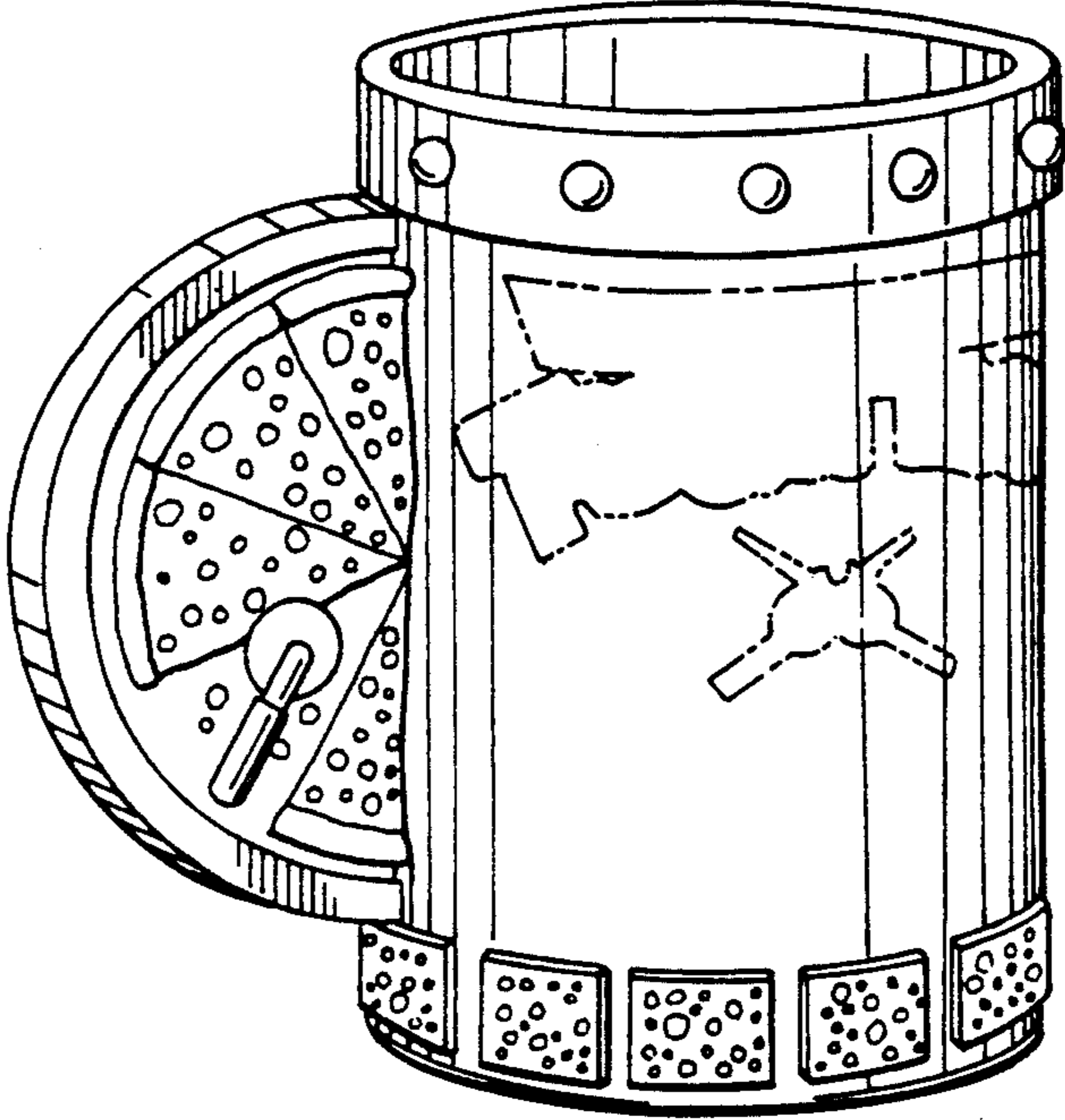

FIG. 2

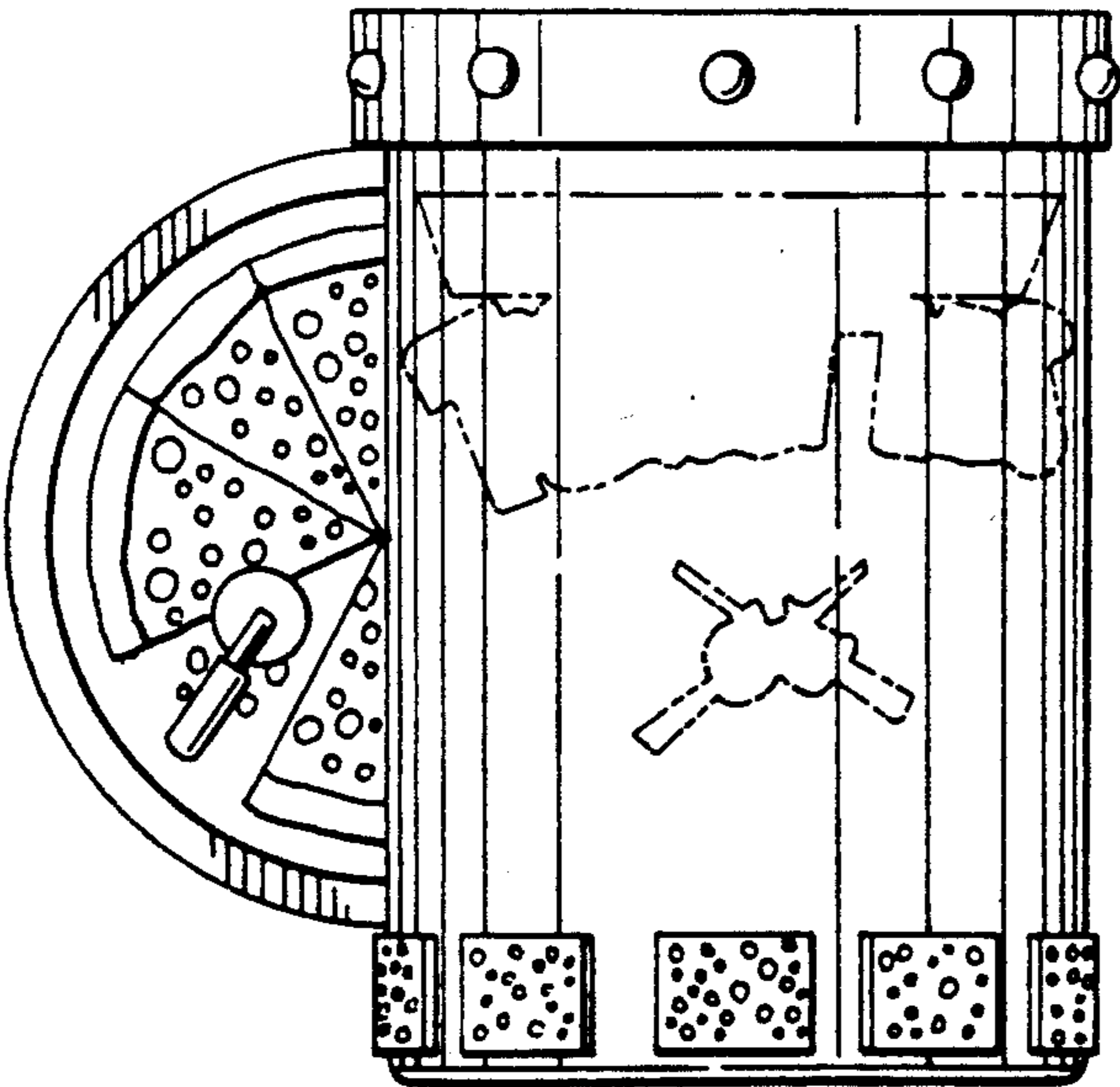

FIG. 3

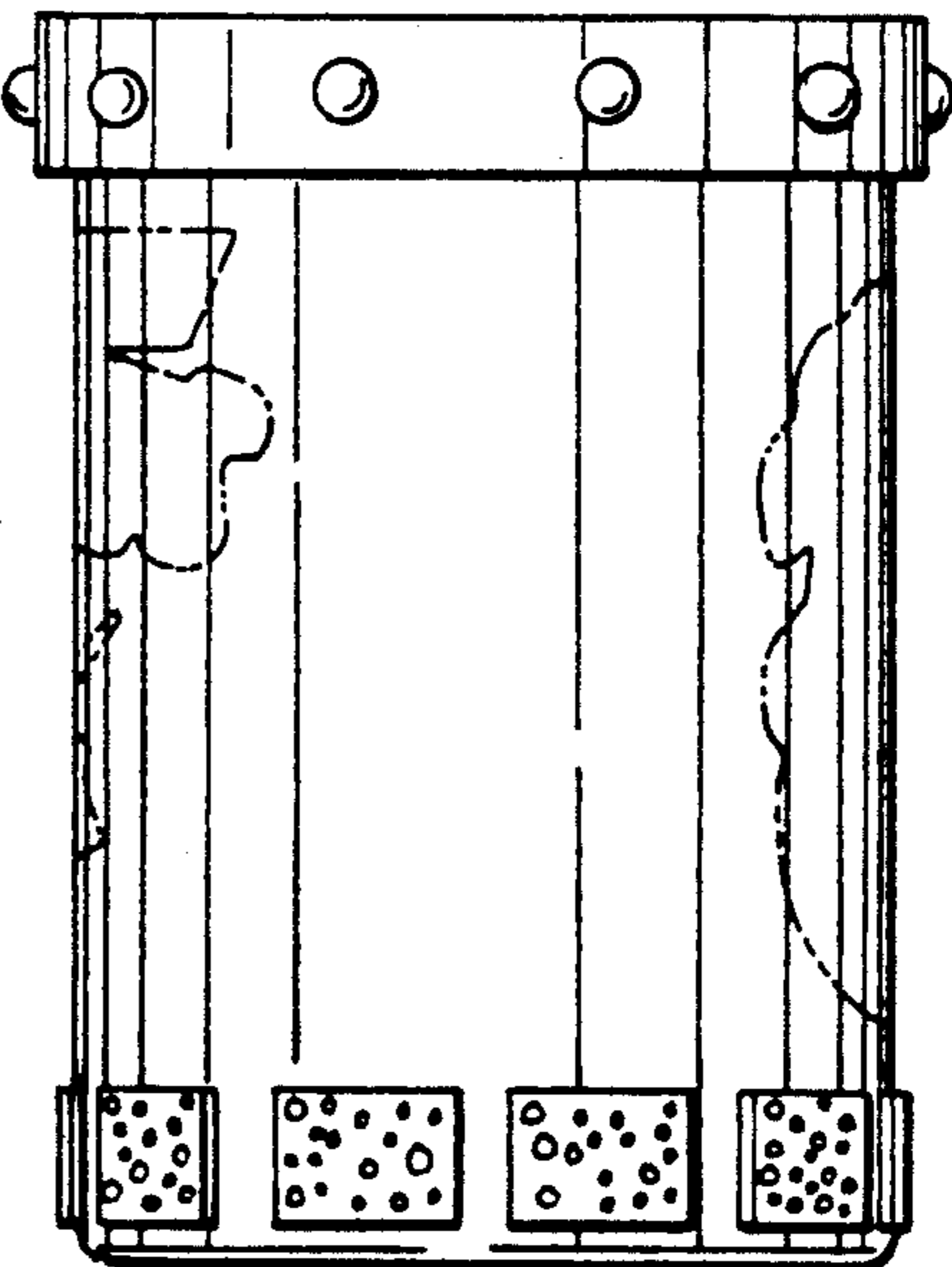

FIG. 4

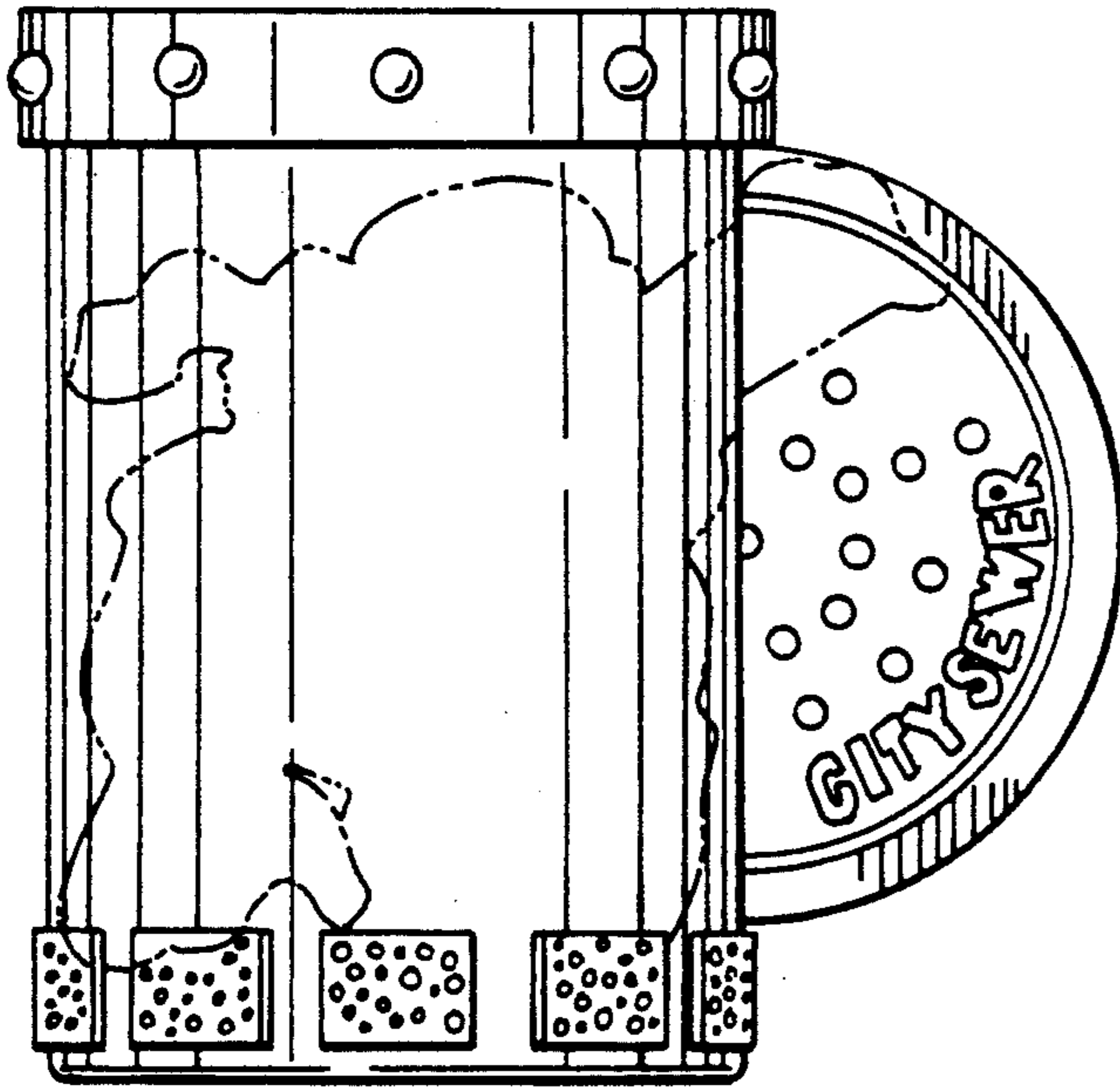

FIG. 5

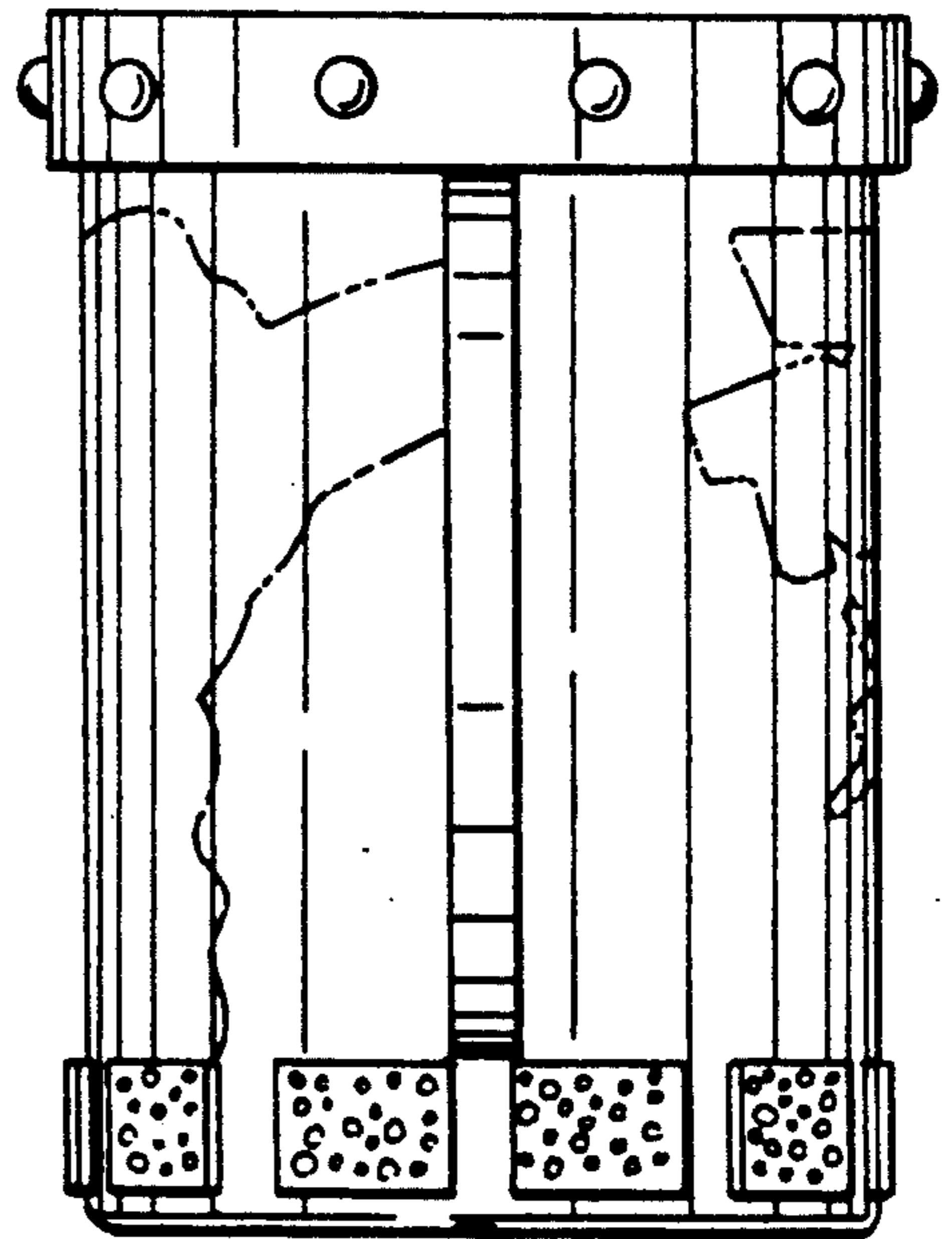

FIG. 6

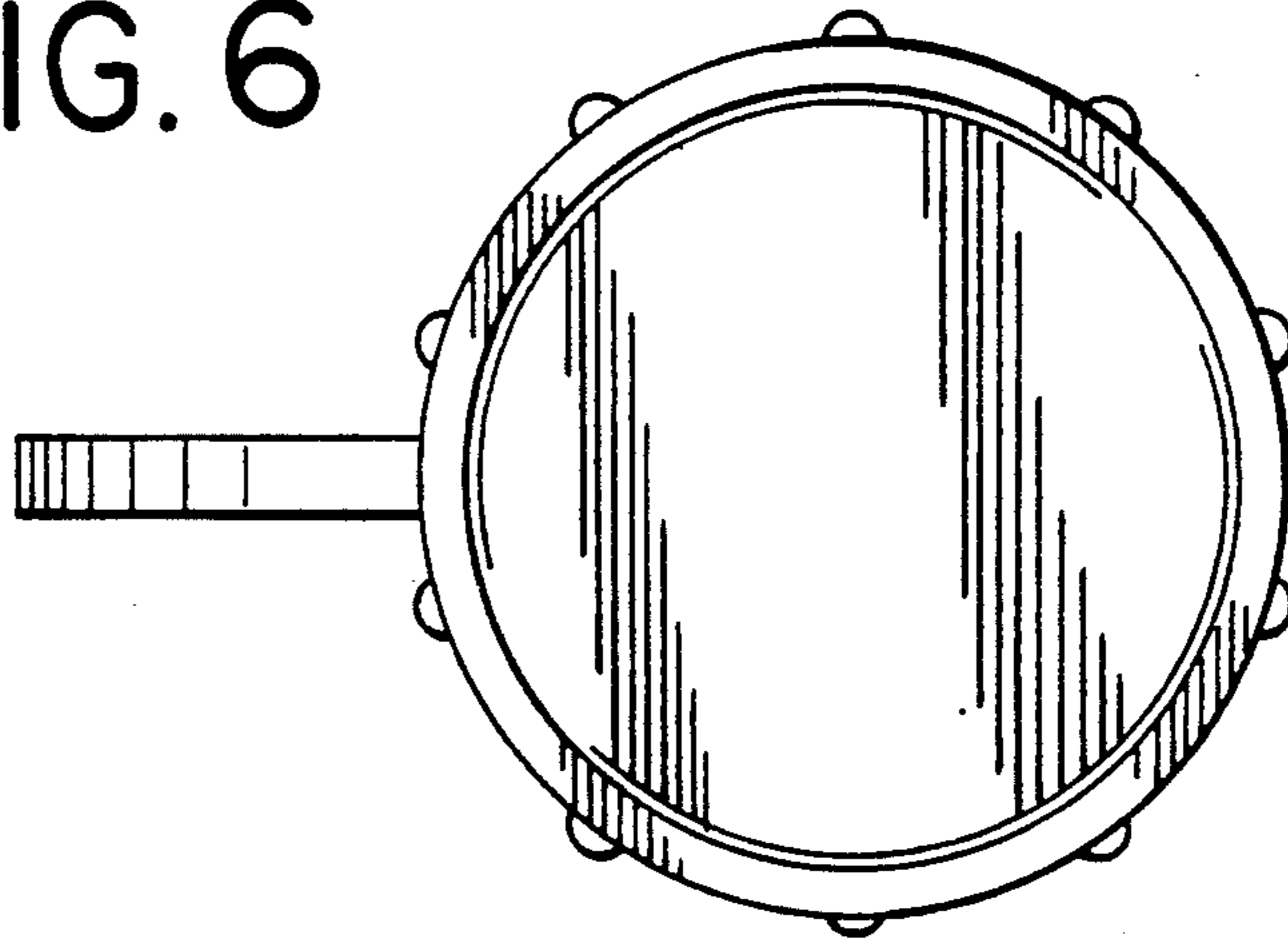

FIG. 7

