



US00D333580S

United States Patent [19]

Brummett

[11] Patent Number: **Des. 333,580**

[45] Date of Patent: **** Mar. 2, 1993**

[54] CONTROL CADDY

[76] Inventor: **Beatrice L. Brummett, 5541 E. Tulare Ave., Sp87, Fresno, Calif. 93727**

[**] Term: **14 Years**

[21] Appl. No.: **476,649**

[22] Filed: **Feb. 8, 1990**

[52] U.S. Cl. **D6/491**

[58] Field of Search **D6/491, 492, 494, 495, D6/499, 500-502, 509-511, 513, 514, 553, 466-467; D3/40; D8/373**

[56] References Cited

U.S. PATENT DOCUMENTS

- D. 154,993 8/1949 Crothers D6/553 X
- D. 247,327 2/1978 Tracy D3/40
- D. 306,520 3/1990 McCarthy D3/40
- D. 324,810 3/1992 Maye, Sr. D3/40 X

OTHER PUBLICATIONS

Rubbermaid Spec. Products Cat. ©1978, p. 13, holder at bottom right.

Lillian Vernon, p. 50, Pocket Rack at bottom left.

Lillian Vernon, p. 48, Bed Caddy center right.

Potpourri-Holiday 1989, p. 58, item A at top left-Arm-chair Caddy.

Primary Examiner—Nelson C. Holtje

Assistant Examiner—J. E. Seeger

Attorney, Agent, or Firm—Leon Gilden

[57] CLAIM

The ornamental design for a control caddy, as shown and described.

DESCRIPTION

FIG. 1 is a front elevational view of the control caddy showing my new design;

FIG. 2 is a rear elevational view thereof;

FIG. 3 is a left side elevational view thereof;

FIG. 4 is a right side elevational view thereof;

FIG. 5 is a top plan view thereof;

FIG. 6 is a bottom plan view thereof; and,

FIG. 7 is a perspective view thereof.

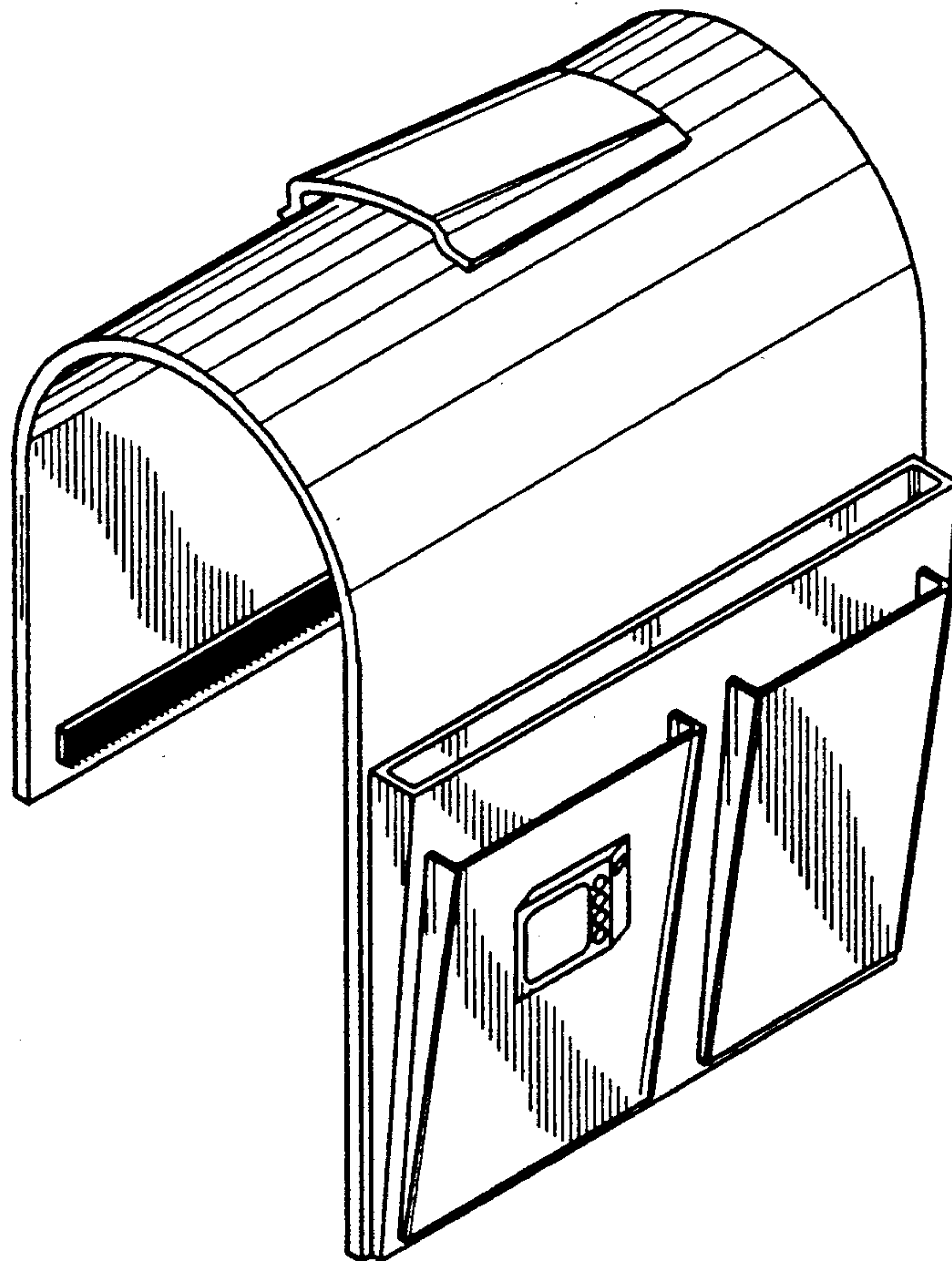

FIG. 1

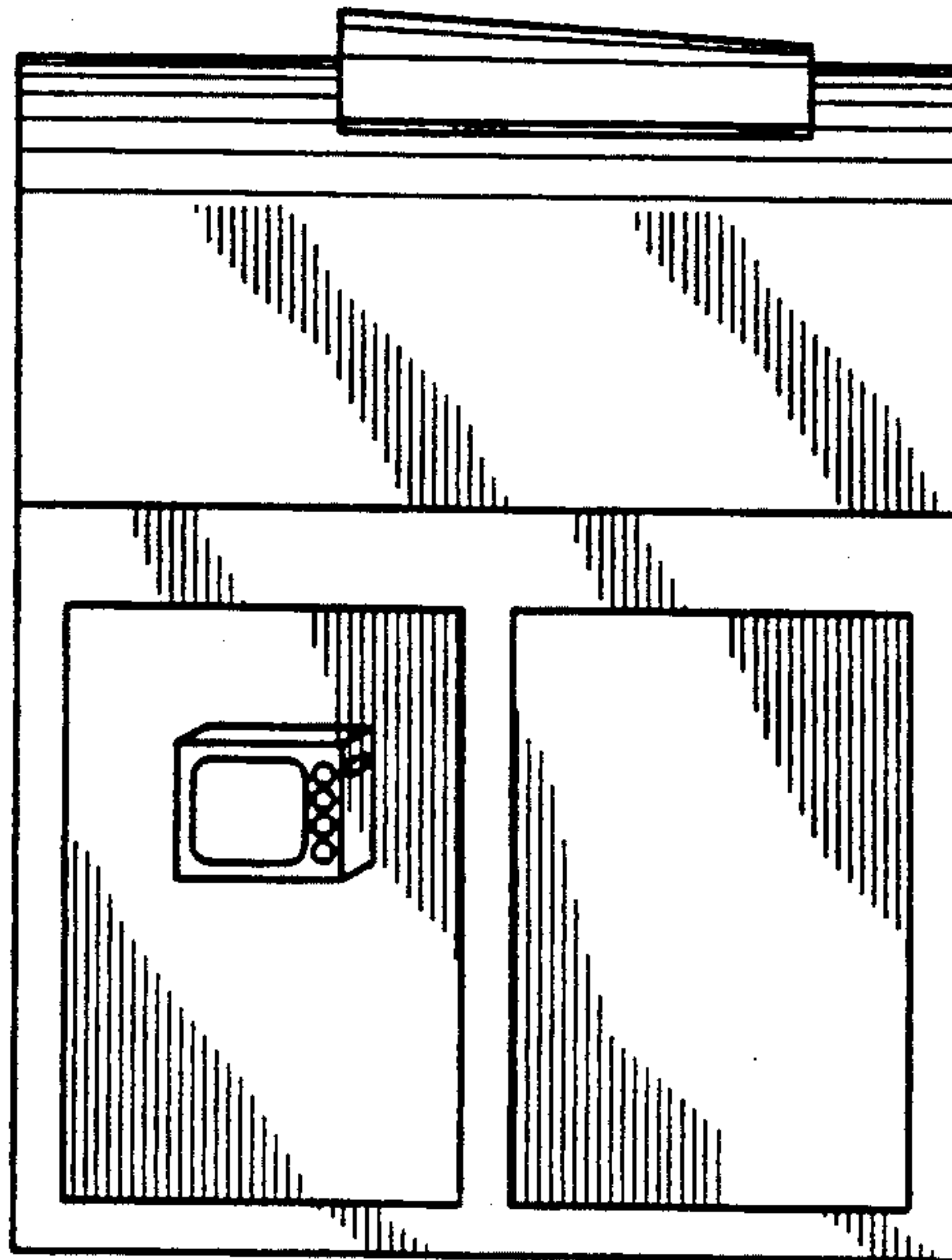

FIG. 2

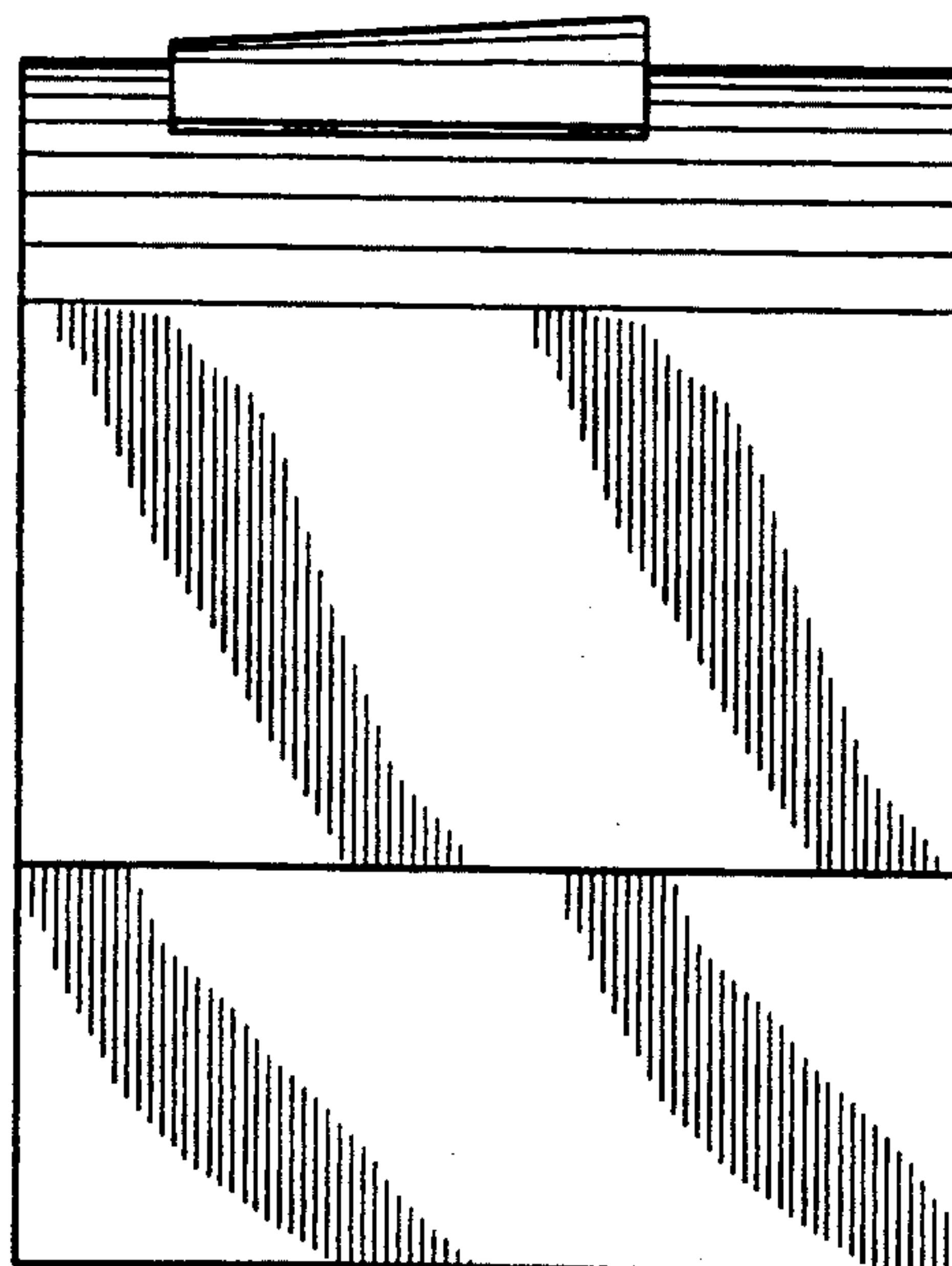

FIG. 3

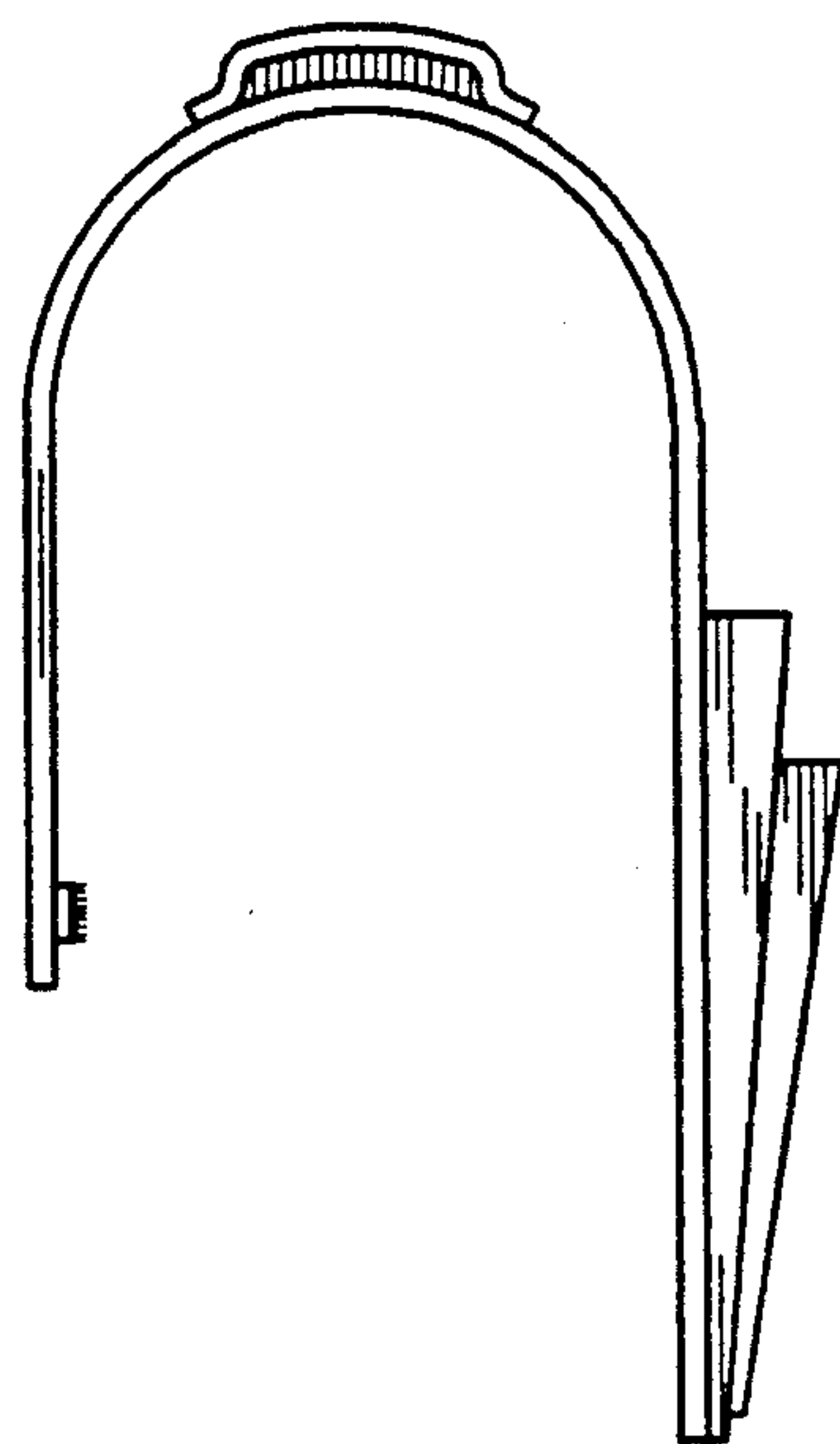

FIG. 4

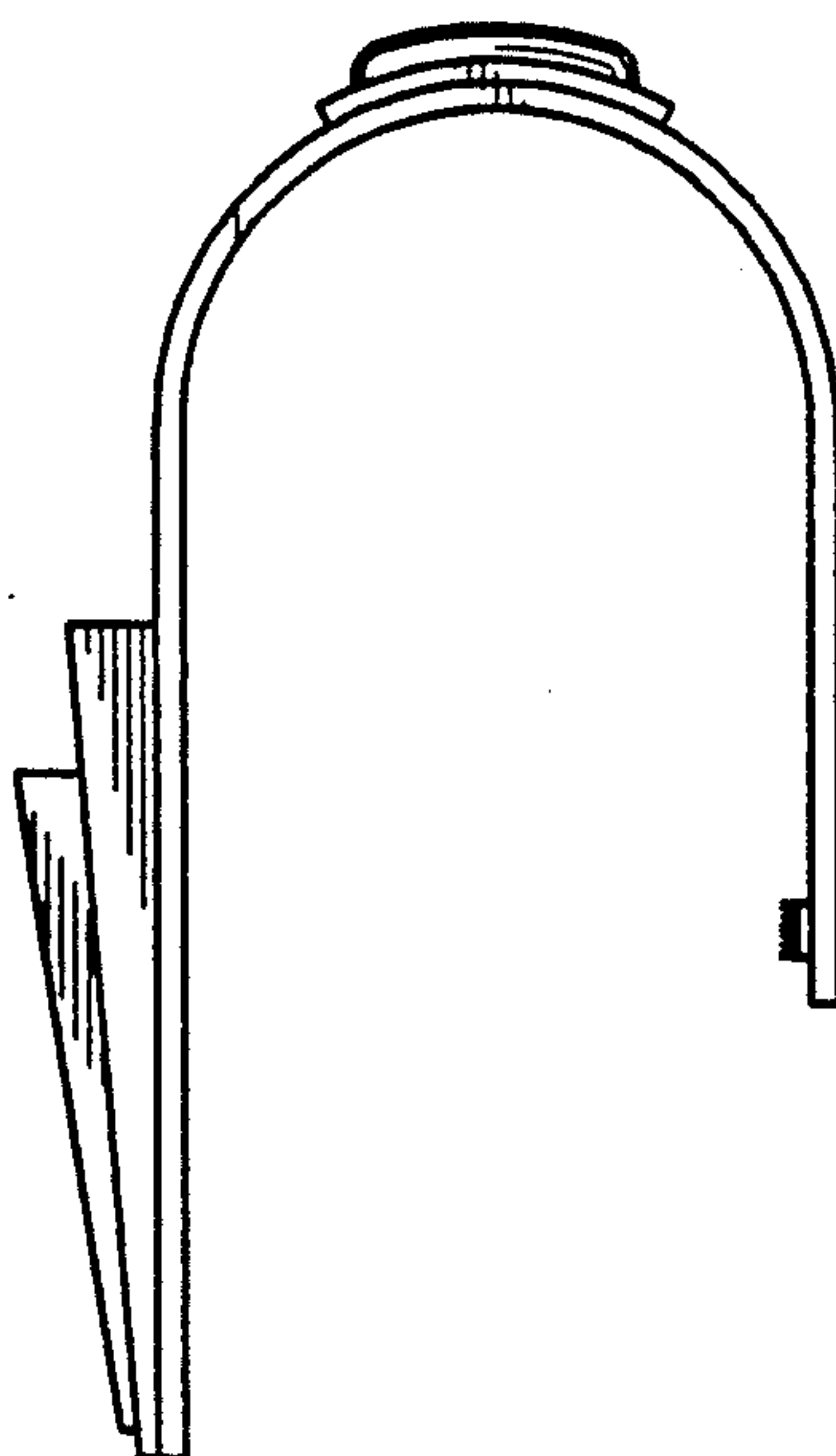

FIG. 5

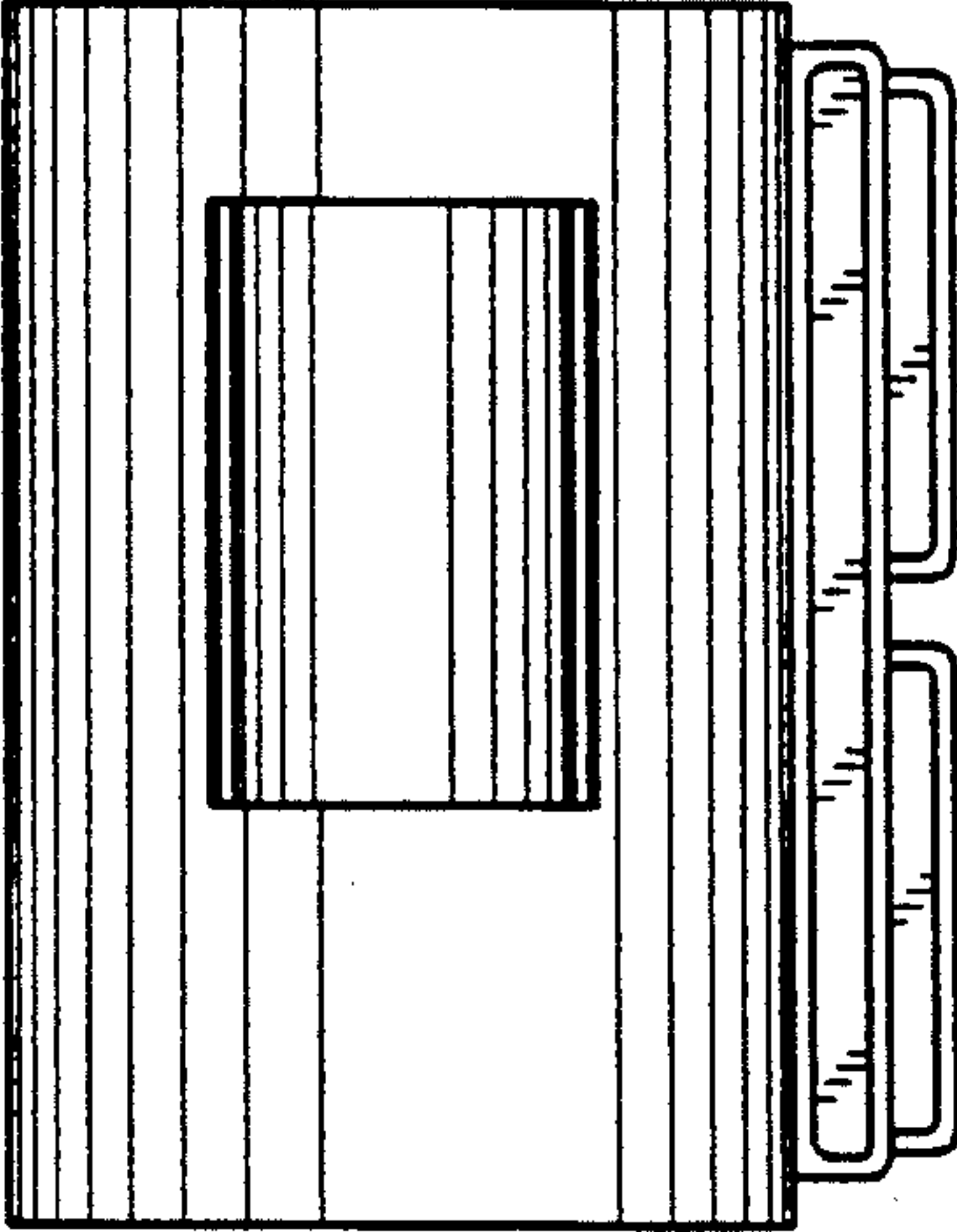

FIG. 6

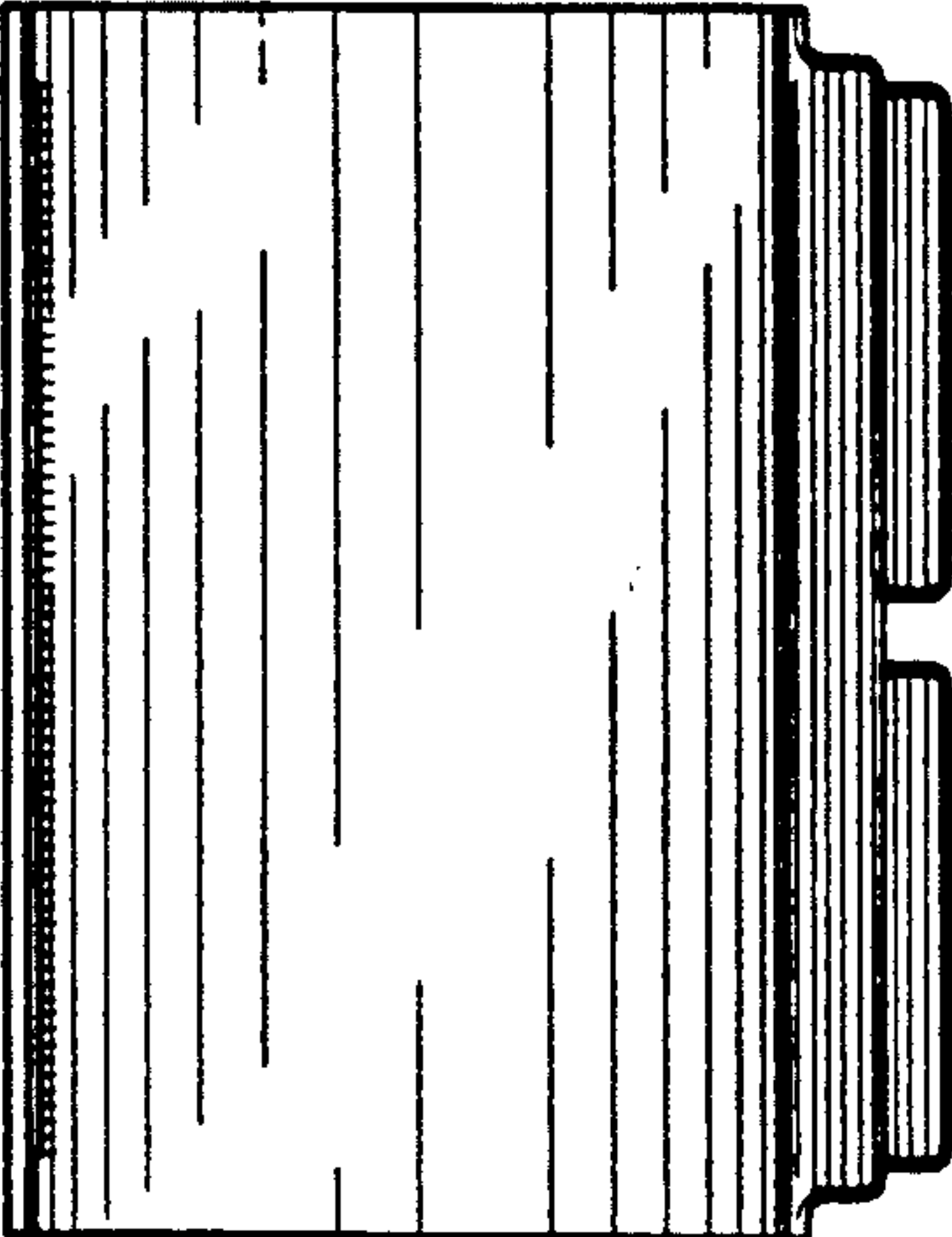

FIG. 7

