



US00D333566S

United States Patent [19]

Landreau

[11] Patent Number: **Des. 333,566**

[45] Date of Patent: **** Mar. 2, 1993**

[54] **TRAVEL BAG**

[75] Inventor: **Michel Landreau, Annecy, France**

[73] Assignee: **Salomon S.A., Chavanod, France**

[**] Term: **14 Years**

[21] Appl. No.: **646,332**

[22] Filed: **Jan. 28, 1991**

[30] **Foreign Application Priority Data**

Jul. 27, 1990 [IB] Int'l Pat. Institute **DMA 001295**

[52] U.S. Cl. **D3/71**

[58] Field of Search **D3/77, 36, 72, 37;**
190/18 A, 108, 109, 110, 111, 900, 901, 902,
15.1, 124, 127, 113, 114, 115, 110, 119; 150/106,
113, 107, 110; 383/110

[56] **References Cited**

U.S. PATENT DOCUMENTS

- D. 222,688 11/1971 Canton D3/36
- D. 264,146 5/1982 Davis D3/36
- D. 267,443 1/1983 Salas D3/36

- D. 275,531 9/1984 Petrie D3/72 X
- D. 319,346 8/1991 Jesson D3/37
- 2,510,643 6/1950 Long 190/119 X
- 4,210,186 7/1980 Belenson 190/110 X
- 5,005,679 4/1991 Hjelle 190/110

Primary Examiner—A. Hugo Word
Assistant Examiner—Paula A. Mortimer
Attorney, Agent, or Firm—Pollock, Vande Sande & Priddy

[57] **CLAIM**

The ornamental design for a travel bag, as shown and described.

DESCRIPTION

FIG. 1 is a front perspective view of a travel bag showing my new design;
FIG. 2 is a front elevational view thereof;
FIG. 3 is a top plan view thereof;
FIG. 4 is a rear elevation view thereof;
FIG. 5 is a bottom plan view thereof;
FIG. 6 is a left end elevational view thereof; and,
FIG. 7 is a right end elevational view thereof.

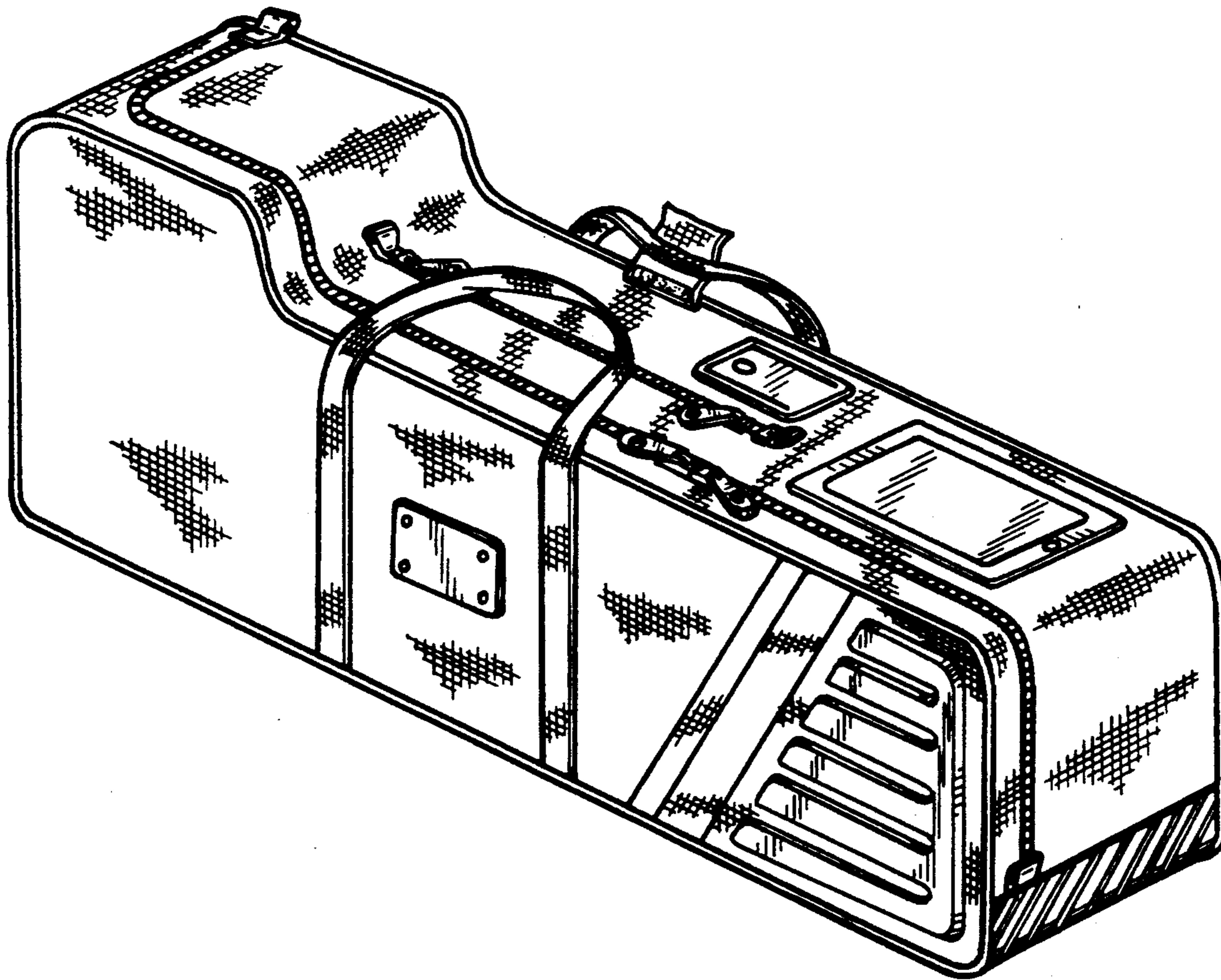

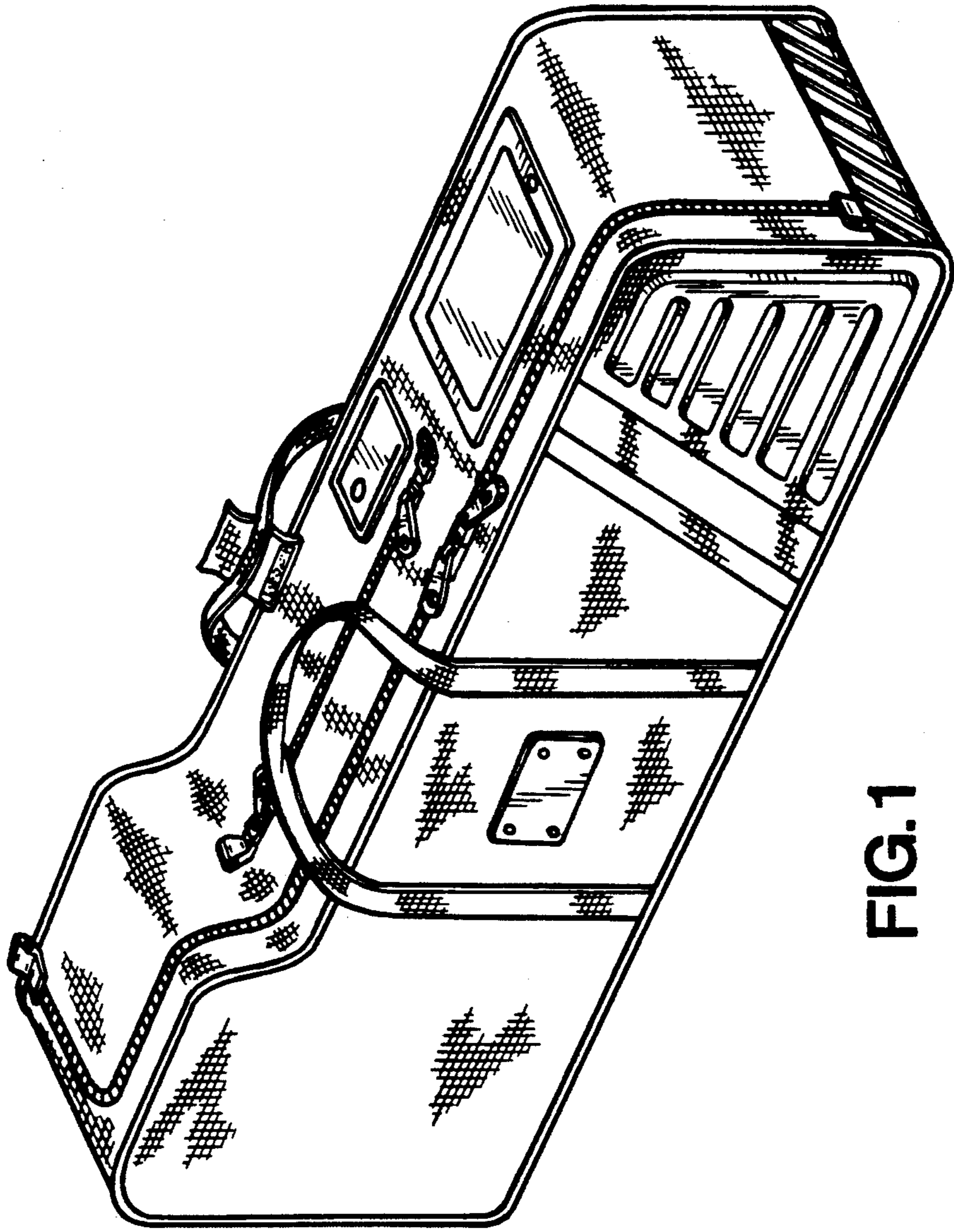

FIG.1

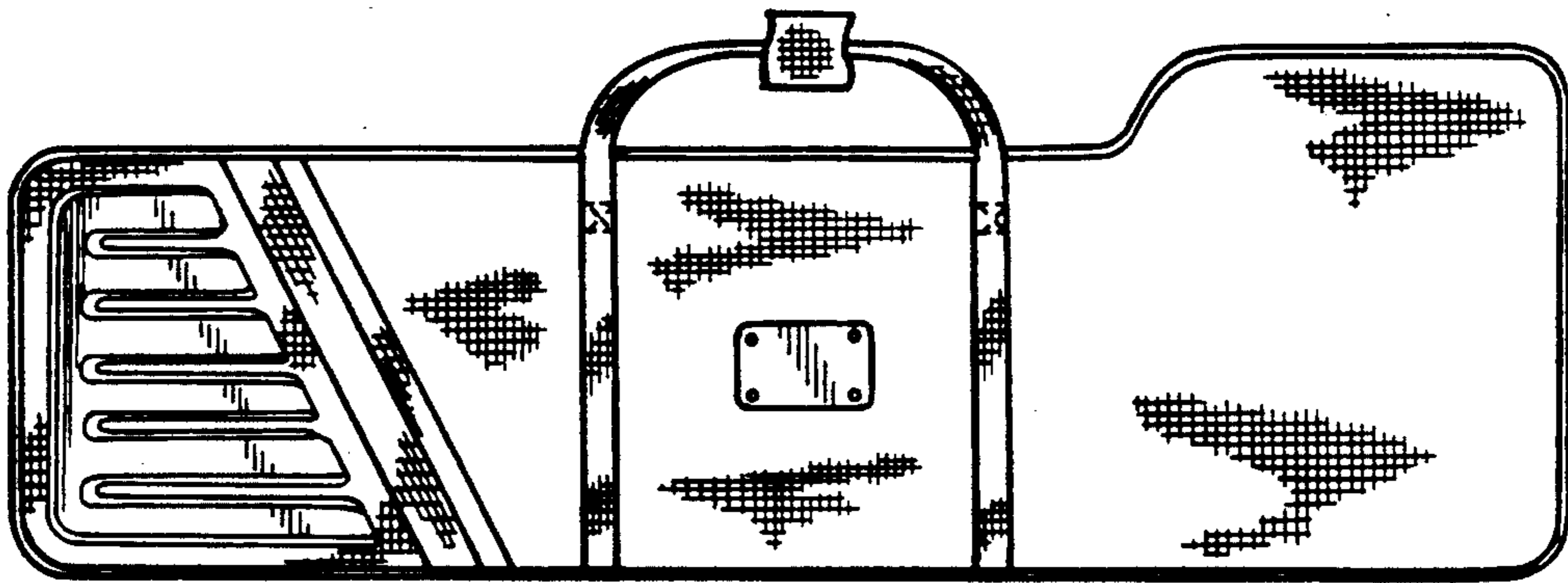

FIG. 2

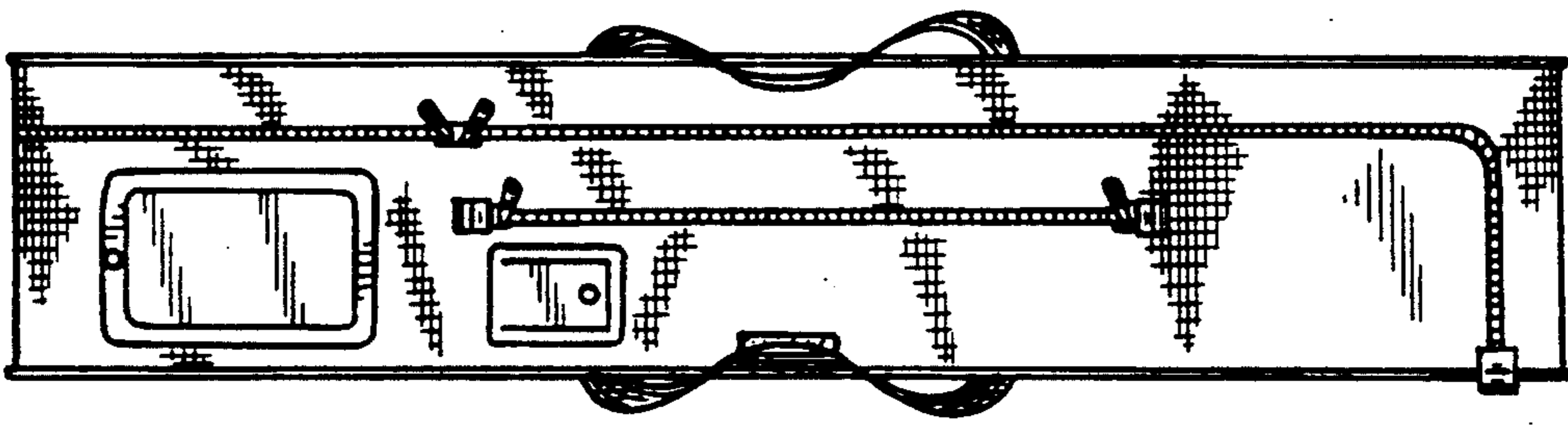

FIG. 3

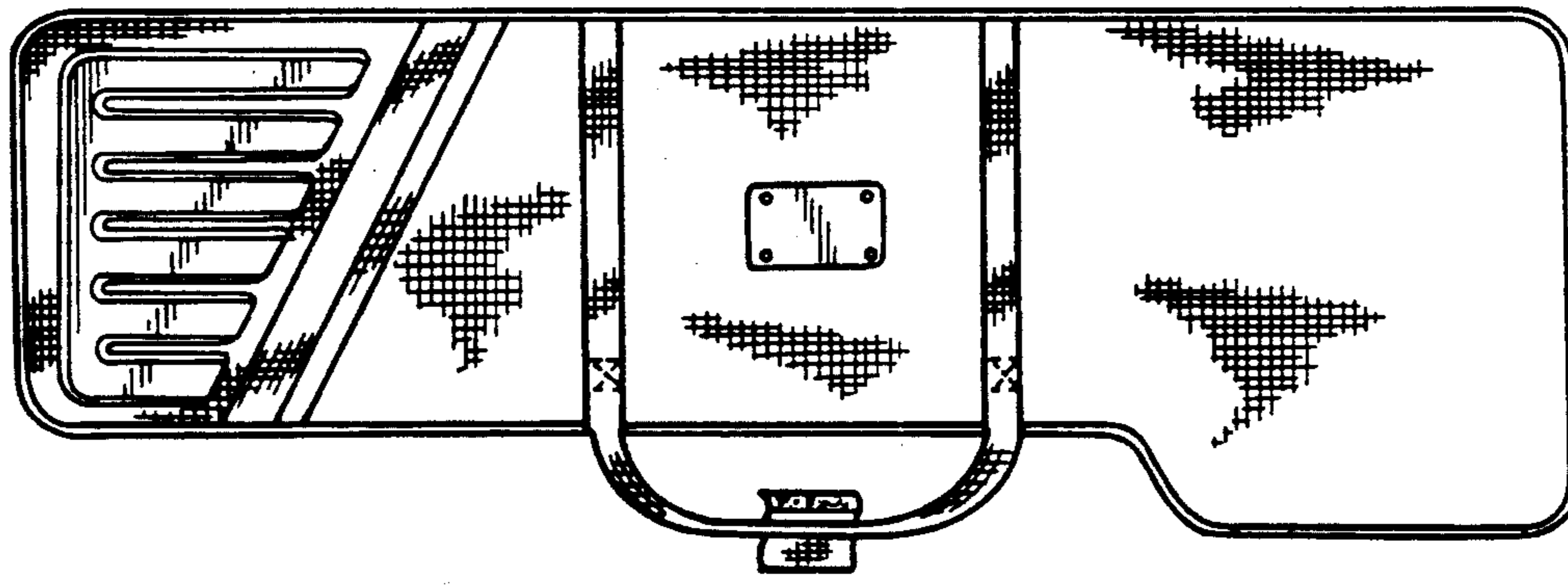

FIG. 4

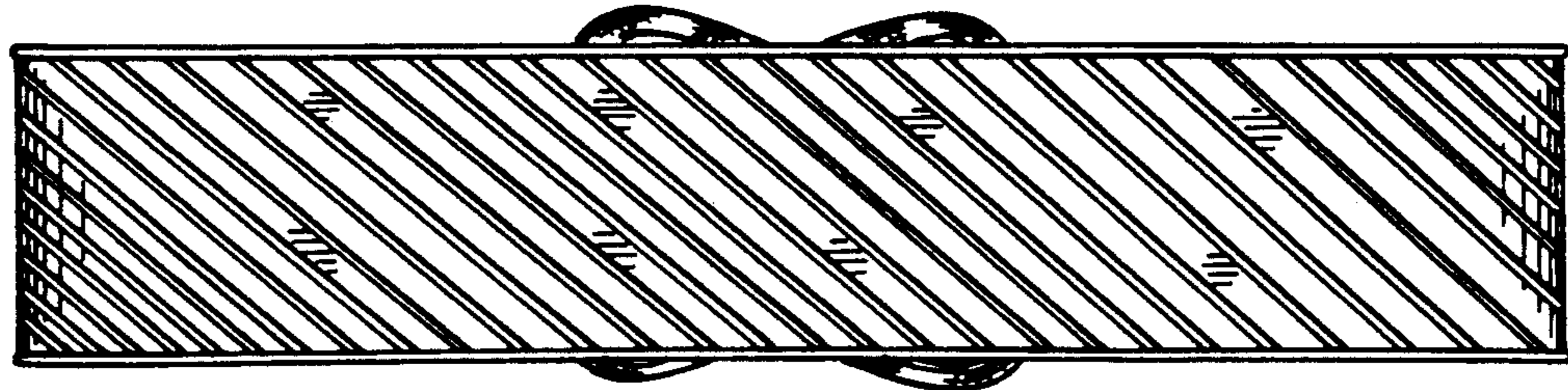

FIG. 5

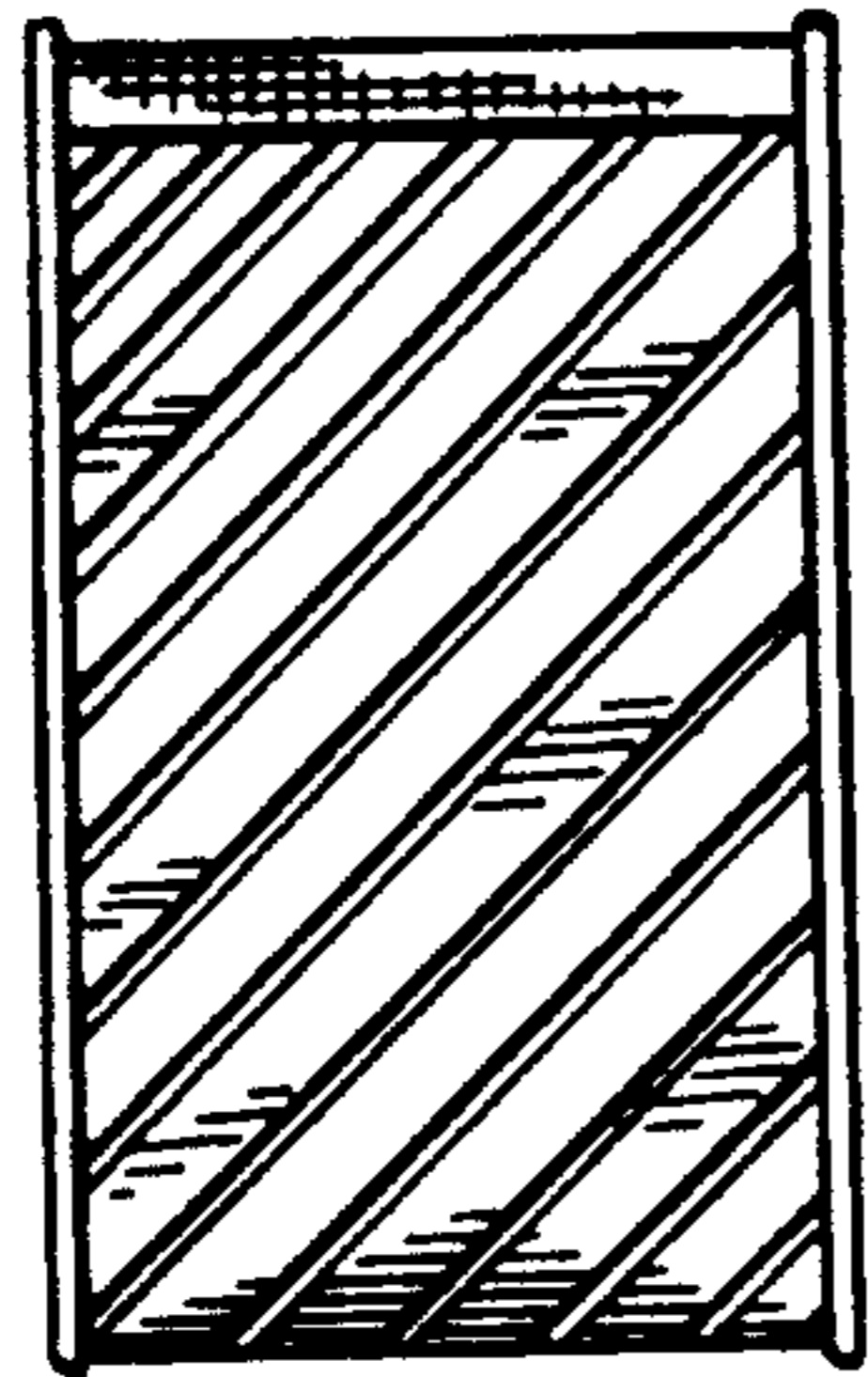

FIG. 6

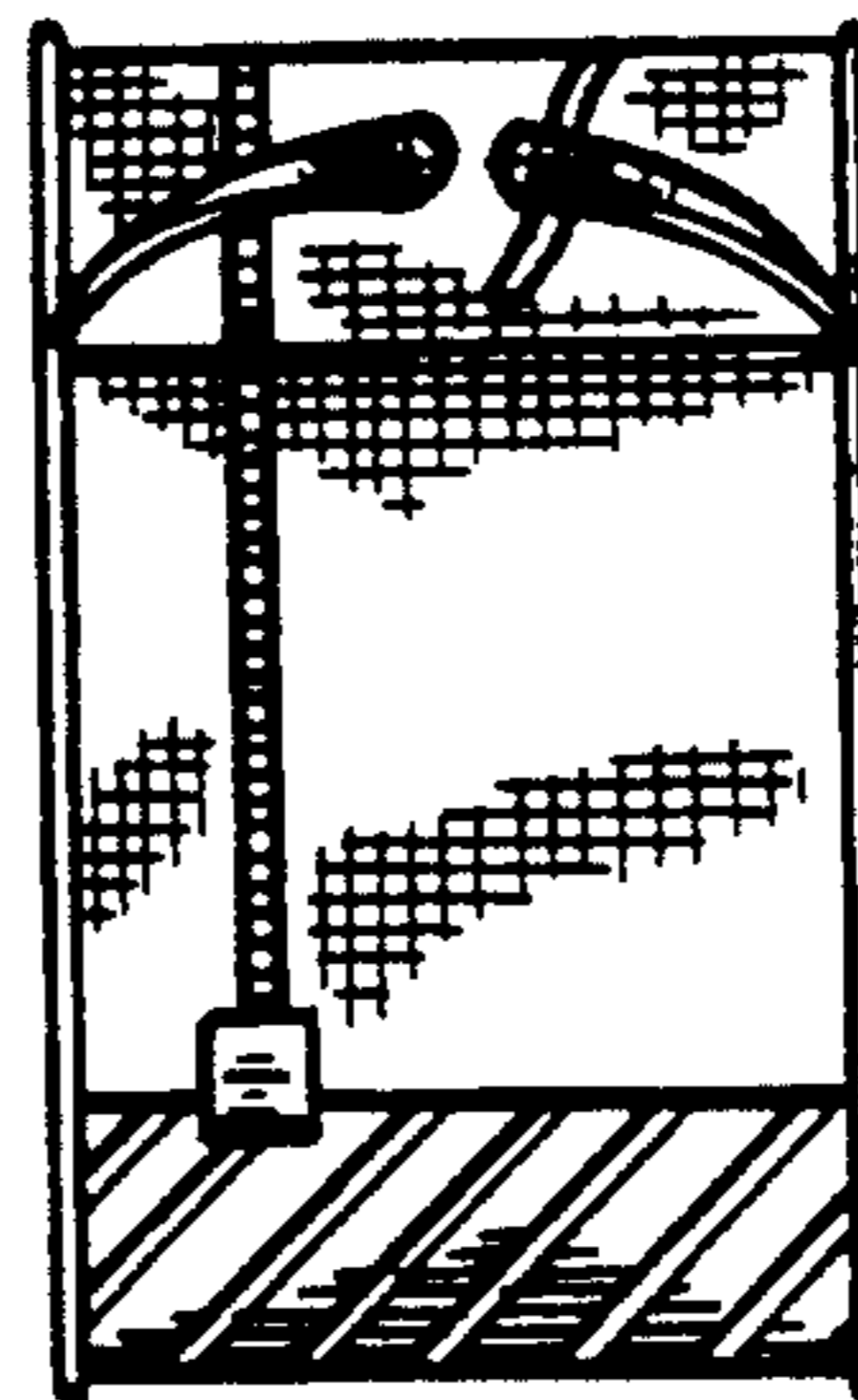

FIG. 7