



US00D333528S

**United States Patent** [19]  
**Blet**

[11] **Patent Number: Des. 333,528**  
[45] **Date of Patent: \*\* Feb. 23, 1993**

[54] **ADJUSTABLE LAMP**

[75] **Inventor: Thierry Blet, Paris, France**

[73] **Assignee: Societe Elixir, Paris, France**

[\*\*] **Term: 14 Years**

[21] **Appl. No.: 731,940**

[22] **Filed: Jul. 18, 1991**

[30] **Foreign Application Priority Data**

Jan. 18, 1991 [FR] France ..... 91 0299  
[52] **U.S. Cl. .... D26/62**  
[58] **Field of Search .... D26/60-66;**  
362/401, 402, 413, 418, 419, 427, 428, 269, 275,  
287

[56] **References Cited**

**U.S. PATENT DOCUMENTS**

D. 296,480 6/1988 Engel ..... D26/62  
D. 312,887 12/1990 Magistretti ..... D26/65  
D. 321,948 11/1991 Huang ..... D26/65  
D. 325,647 4/1992 Huang ..... D26/63

*Primary Examiner*—Susan J. Lucas  
*Attorney, Agent, or Firm*—Sandler, Greenblum &  
Bernstein

[57] **CLAIM**

The ornamental design for a adjustable lamp, as shown and described.

**DESCRIPTION**

FIG. 1 is a right side elevational view of an adjustable lamp showing my new design;  
FIG. 2 is a left side elevational view thereof;  
FIG. 3 is a top plan view thereof;  
FIG. 4 is a bottom plan view thereof;  
FIG. 5 is a front elevational view thereof; and,  
FIG. 6 is a rear elevational view thereof.



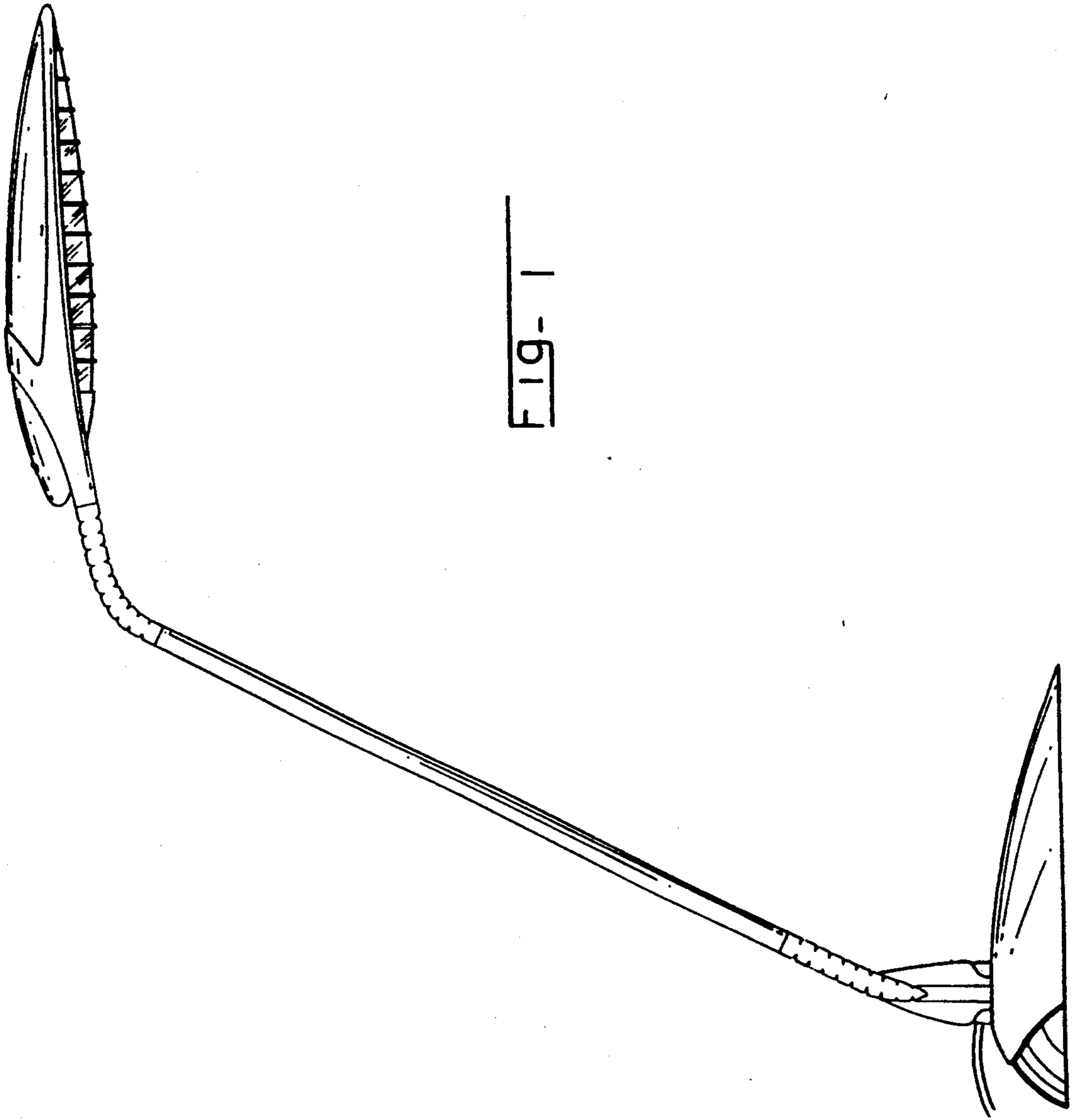

FIG. 1

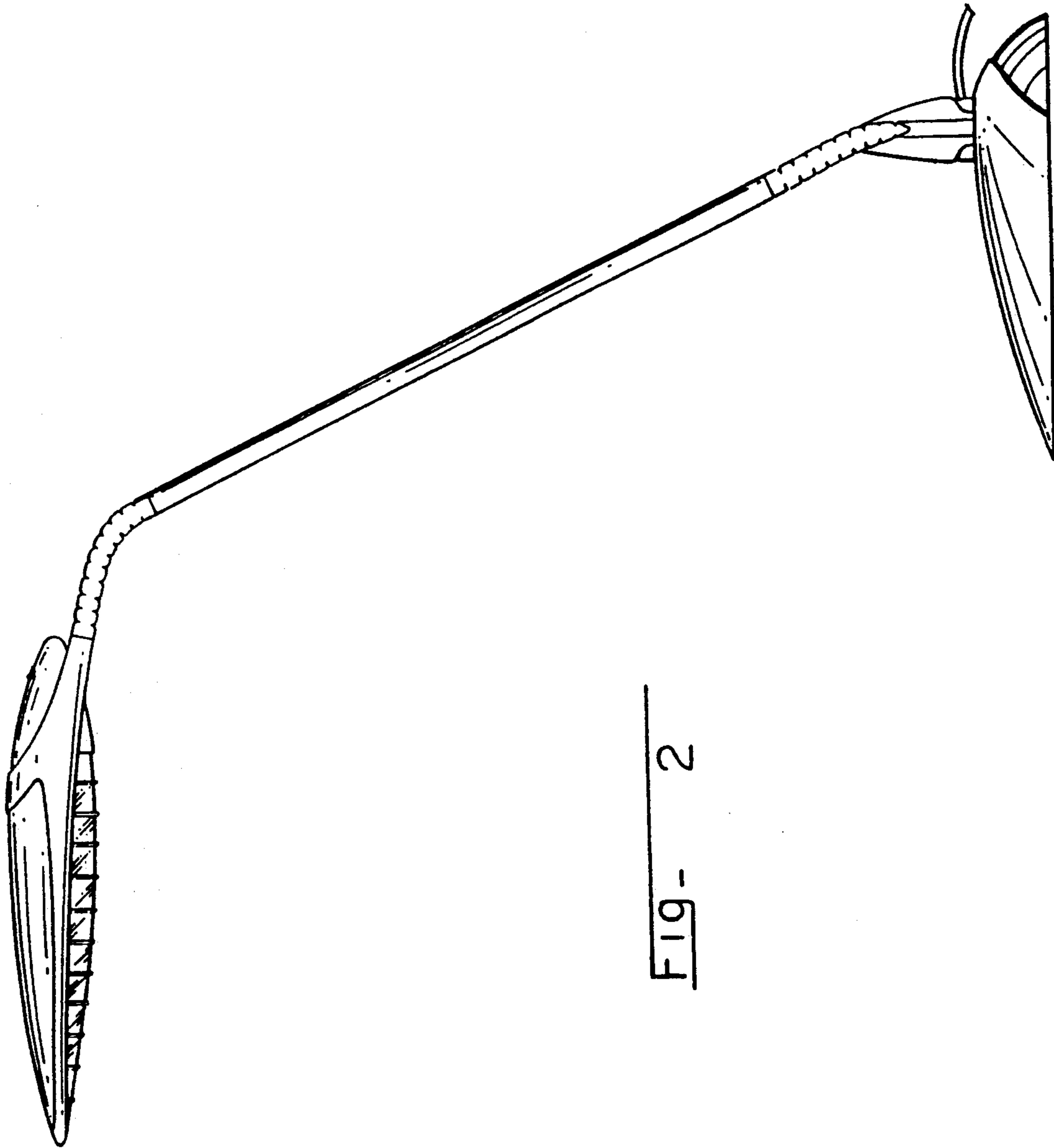
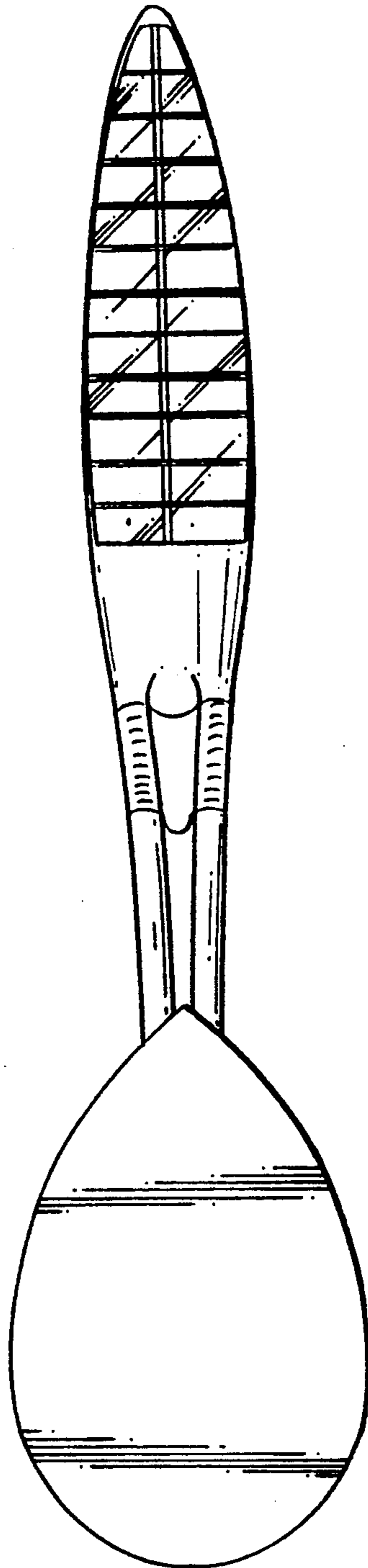
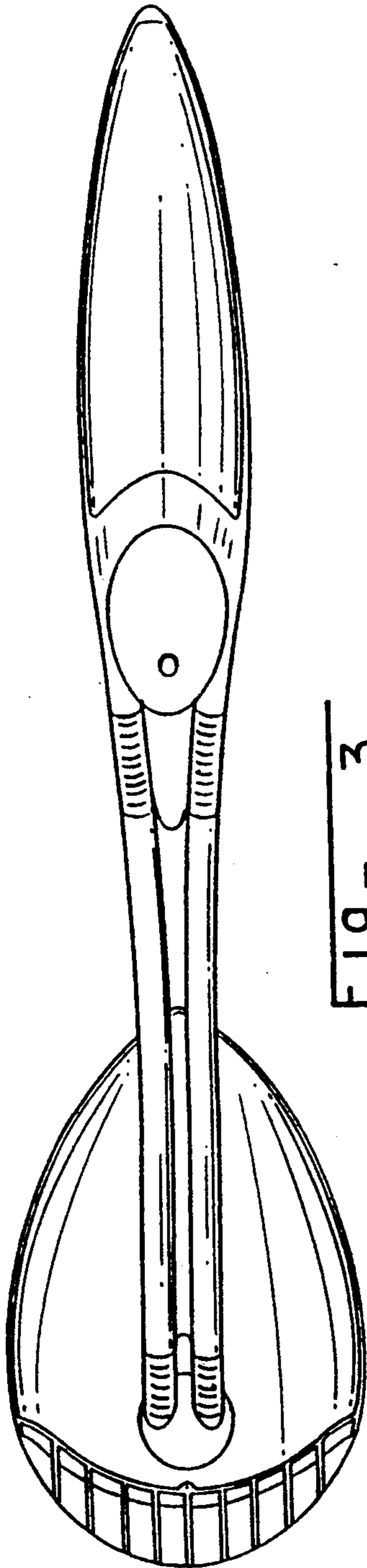

FIG- 2



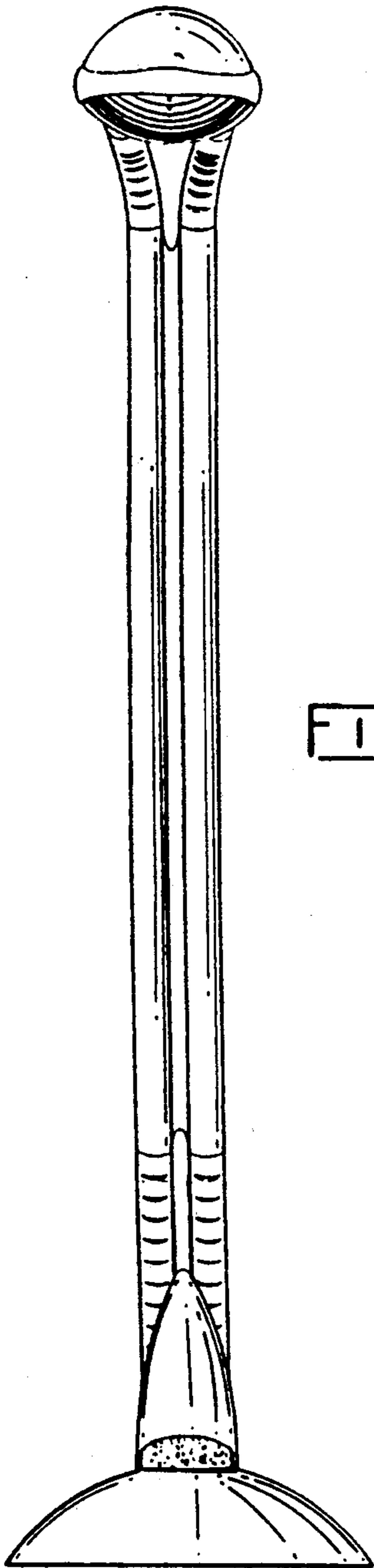

FIG - 5

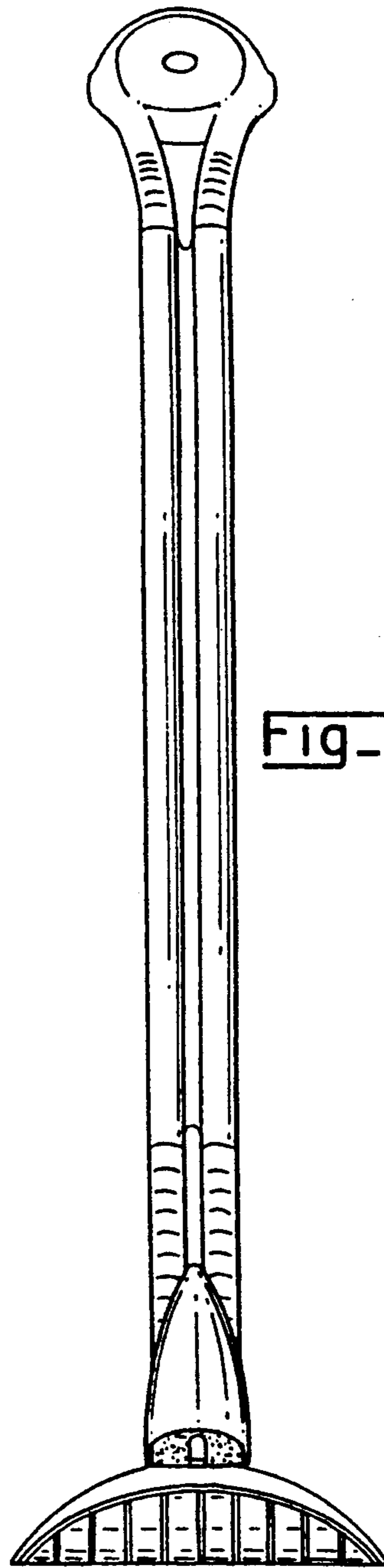

FIG - 6