



US00D333465S

United States Patent [19]

Hayes et al.

[11] Patent Number: **Des. 333,465**

[45] Date of Patent: **** Feb. 23, 1993**

[54] TELEPHONE SET

[75] Inventors: **Robert J. Hayes, Gahanna, Ohio;**
Vincent L. Haley, Raleigh, N.C.;
Robert W. Mervar, Dublin, Ohio

[73] Assignee: **Forerunner Corporation, Columbus, Ohio**

[**] Term: **14 Years**

[21] Appl. No.: **641,563**

[22] Filed: **Jan. 16, 1991**

[52] U.S. Cl. **D14/142; D14/148;**
D14/151; D14/247

[58] Field of Search **D14/148, 248, 142, 243,**
D14/143, 138

[56] References Cited

U.S. PATENT DOCUMENTS

D. 189,877	3/1961	Mosing	D14/148
D. 271,871	12/1983	Shimizu et al.	D14/148
D. 279,004	5/1985	Ryan	D14/248
D. 280,895	10/1985	Kao	D14/148
D. 287,362	12/1986	Rittenhouse et al.	D14/148
D. 301,499	6/1989	Tapdrup	D14/143
D. 303,386	9/1989	Iino et al.	D14/242
D. 319,442	8/1991	Namba et al.	D14/142
D. 319,828	9/1991	Thomke	D14/142 X
D. 321,185	10/1991	Gee et al.	D14/138
D. 322,438	12/1991	Skowronski	D14/142

FOREIGN PATENT DOCUMENTS

1215958 4/1992 United Kingdom D14/151

Primary Examiner—Horace B. Fay, Jr.
Attorney, Agent, or Firm—Mueller and Smith

[57] CLAIM

The ornamental design for a telephone set, as shown and described.

DESCRIPTION

FIG. 1 is a rear, top and right side perspective view of a telephone set;
 FIG. 2 is a top plan view thereof;
 FIG. 3 is a side elevational view thereof;
 FIG. 4 is the side opposite the view of FIG. 3;
 FIG. 5 is a bottom plan view thereof;
 FIG. 6 is a rear elevational view thereof;
 FIG. 7 is a rear elevational view thereof;
 FIG. 8 is a top plan view of the base of the telephone set;
 FIG. 9 is a side elevational view of the handset component of the telephone set shown in FIGS. 1 and 9 thereof;
 FIG. 10 is a bottom plan view of the handset component shown in FIG. 1;
 FIG. 11 is an rear end elevational view of the handset component thereof;
 FIG. 12 is a front end elevational view of the handset component thereof;
 FIG. 13 is a left side, top and front perspective view thereof; and,
 FIG. 14 is a front, bottom and left side perspective view thereof.

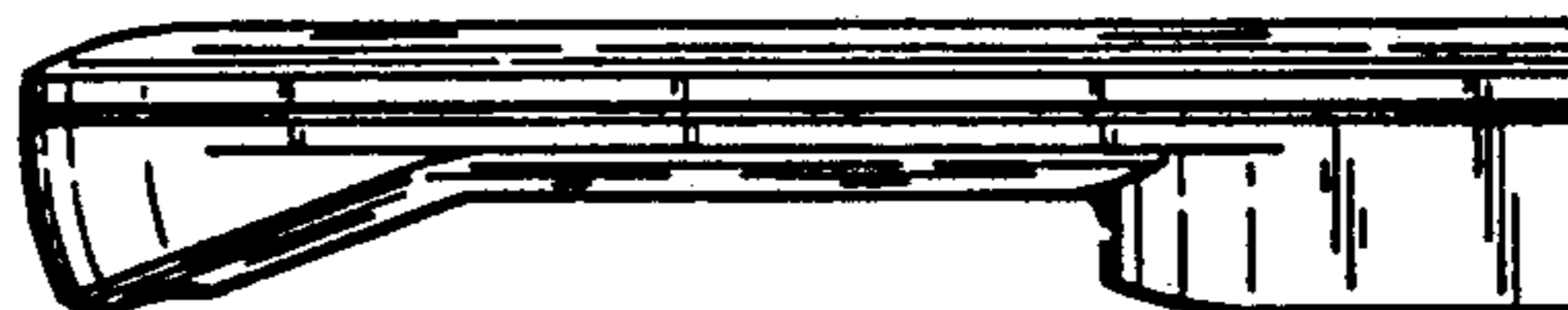
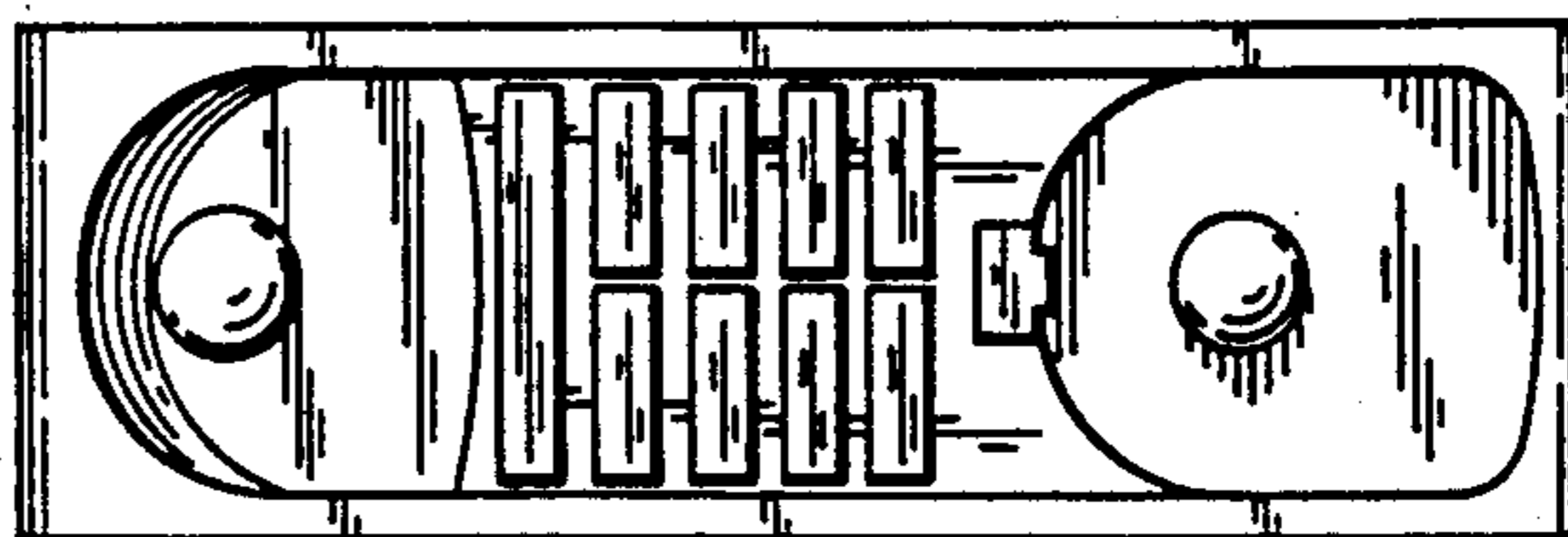
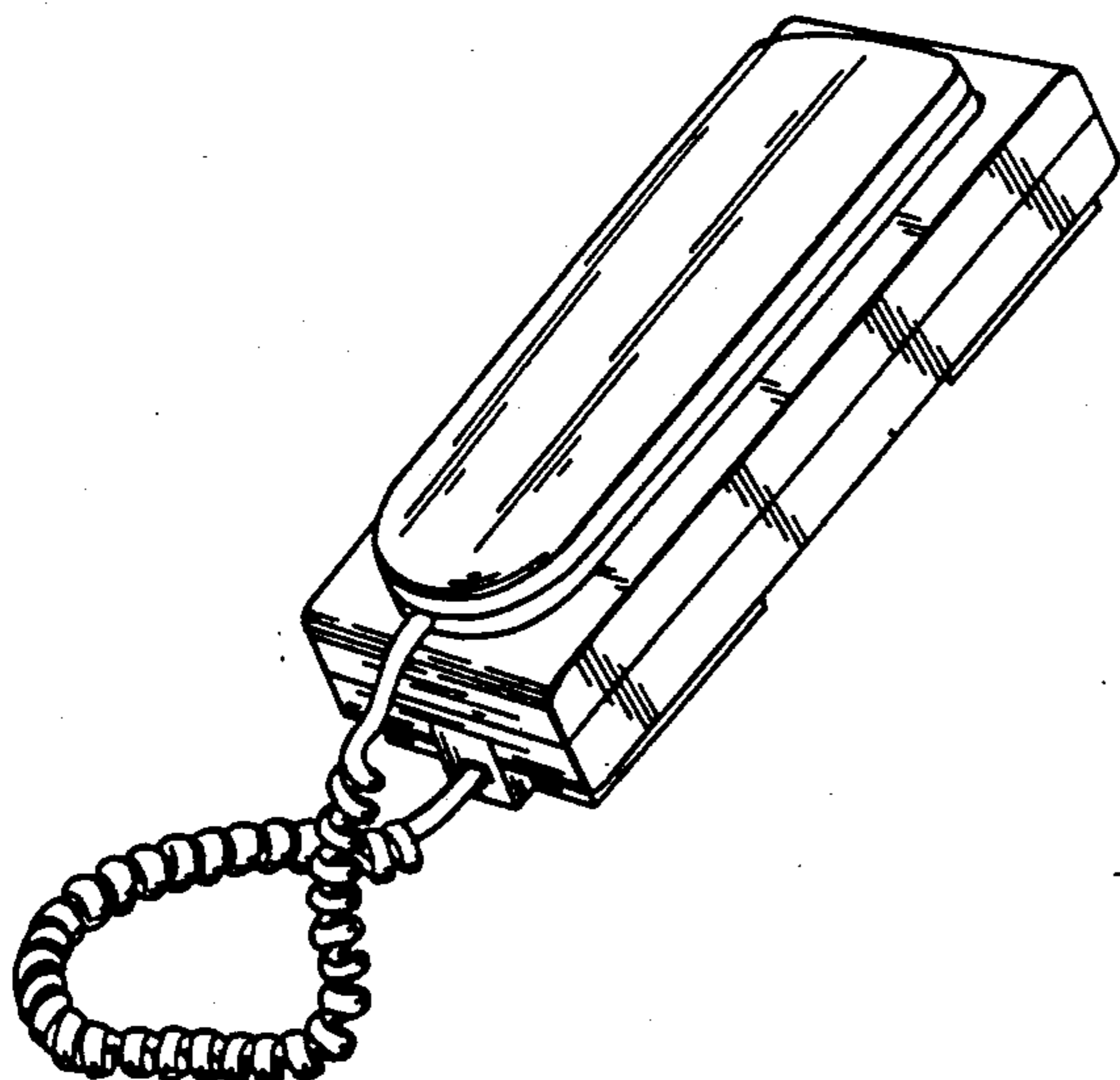

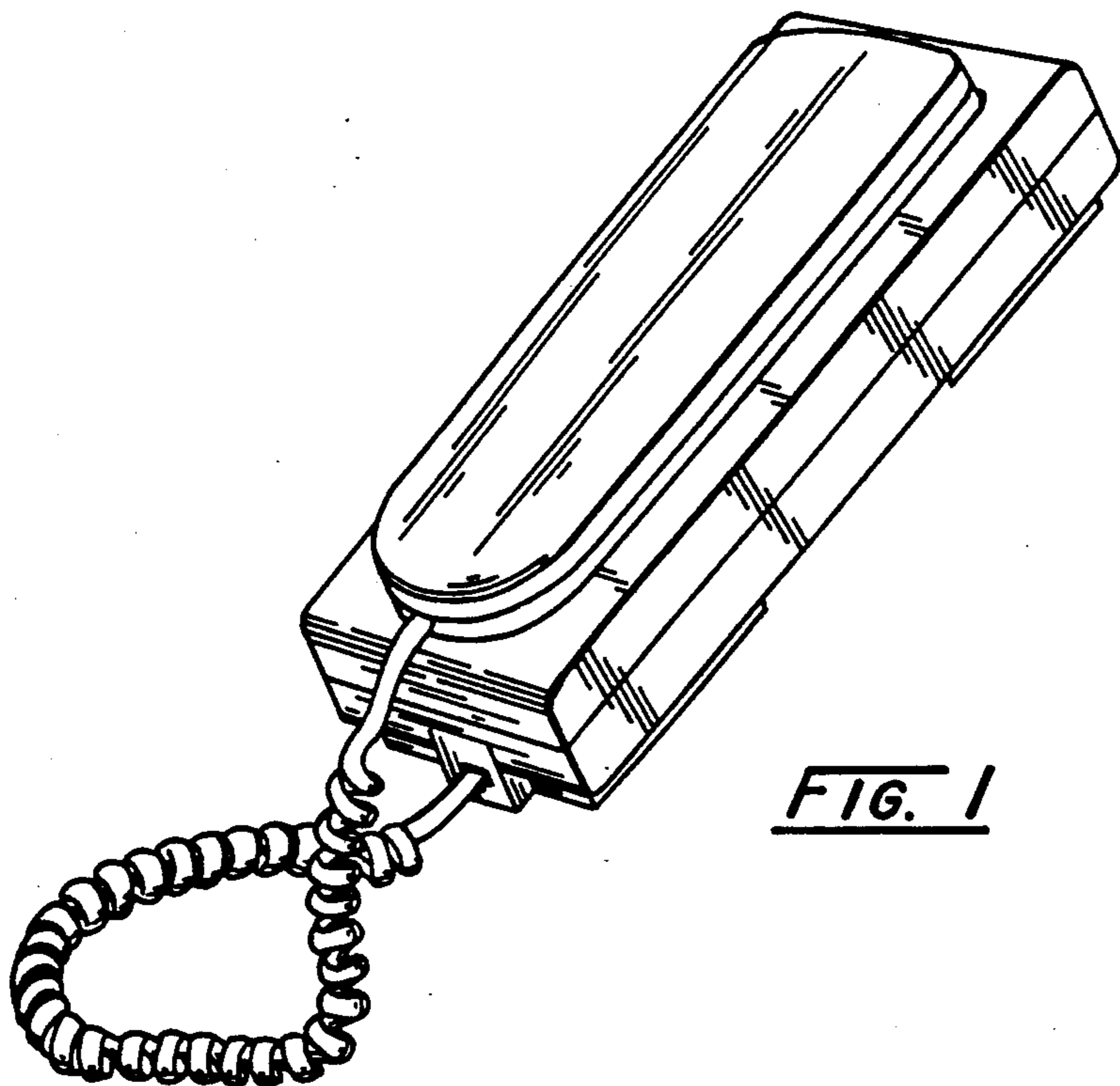

FIG. 1

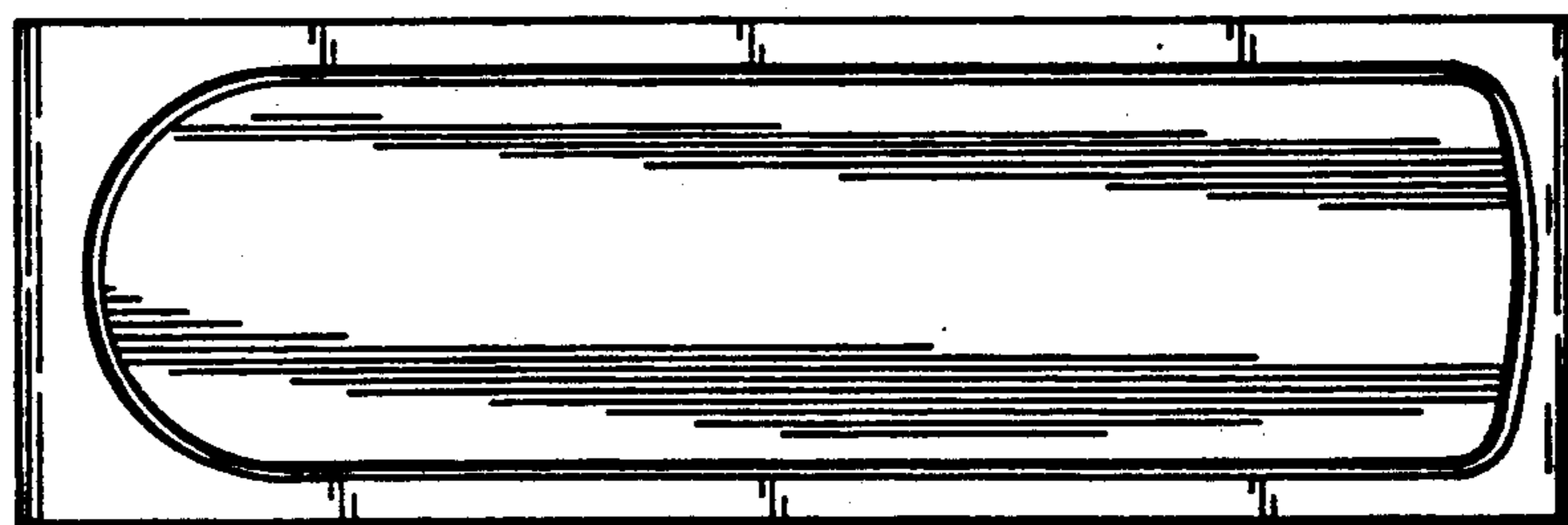

FIG. 2

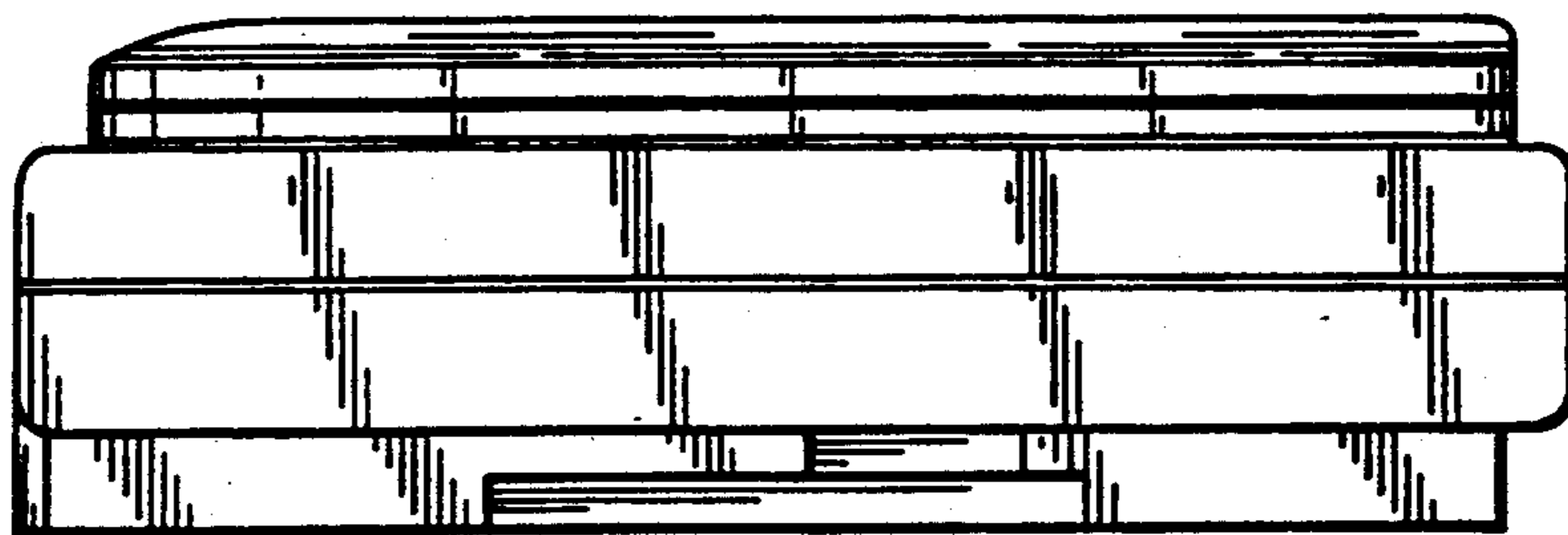

FIG. 3

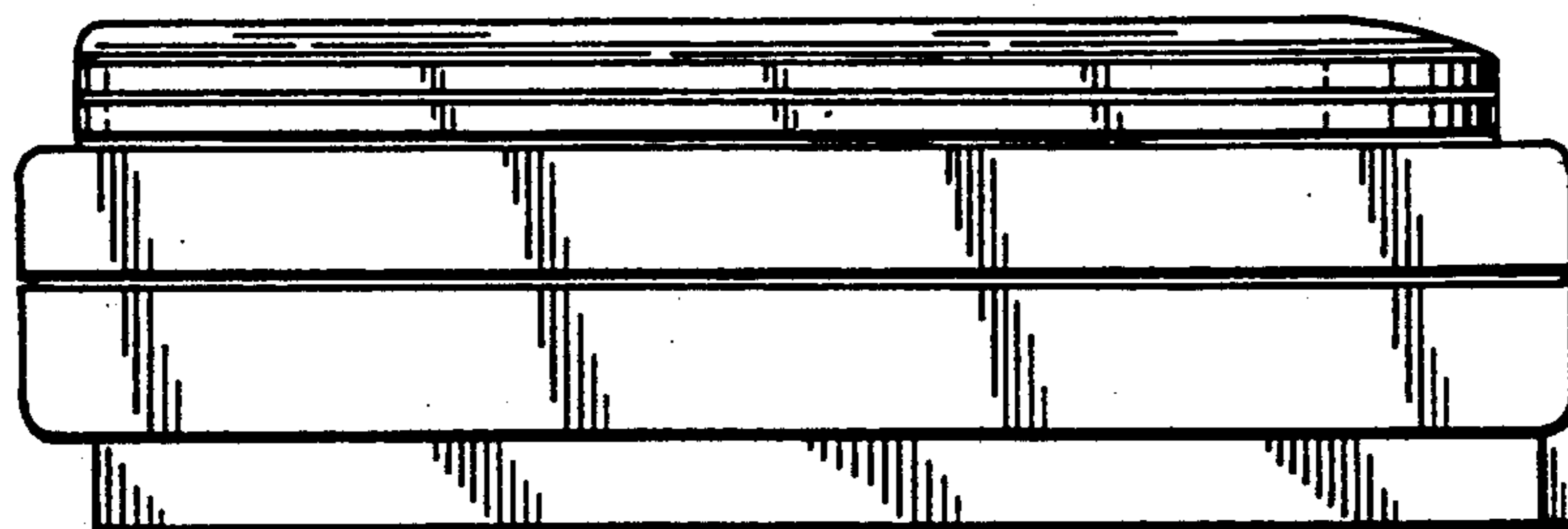

FIG. 4

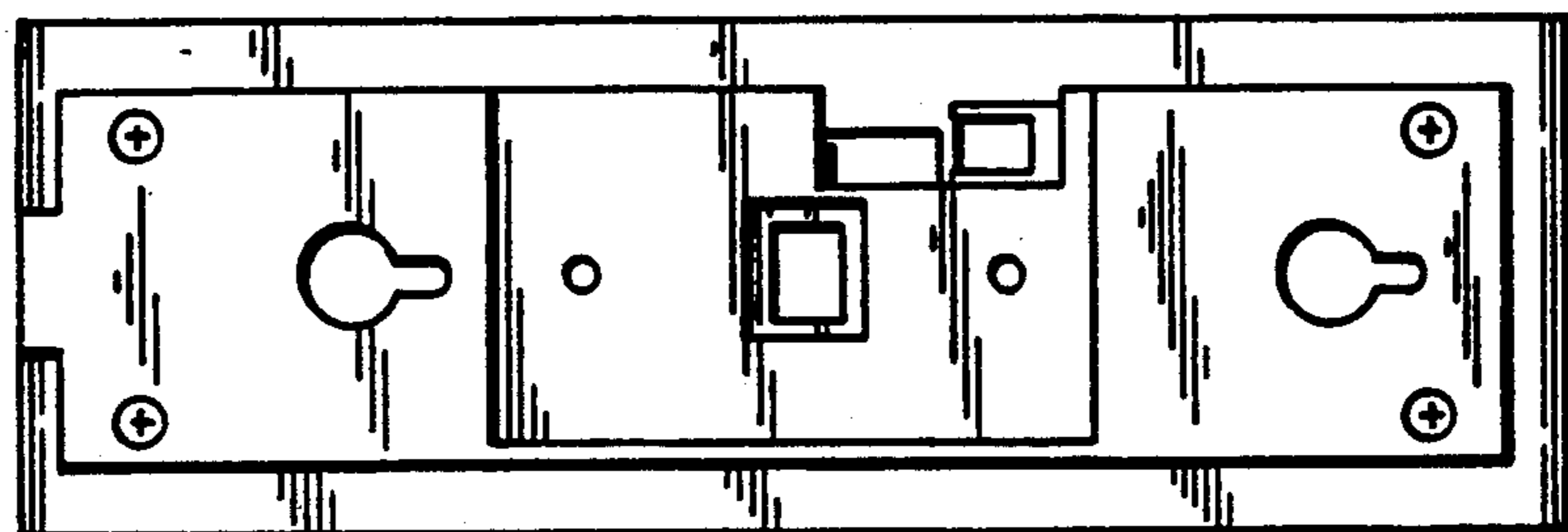

FIG. 5

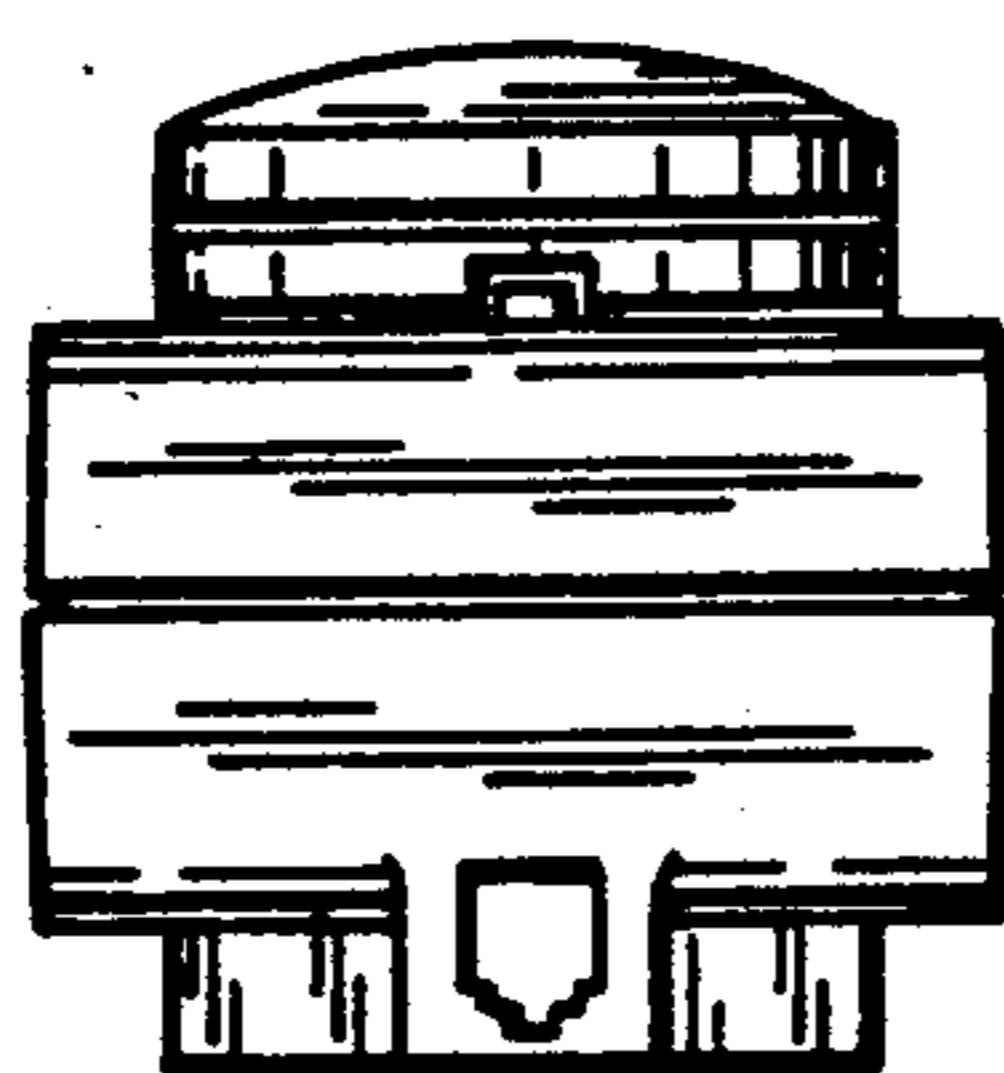

FIG. 6

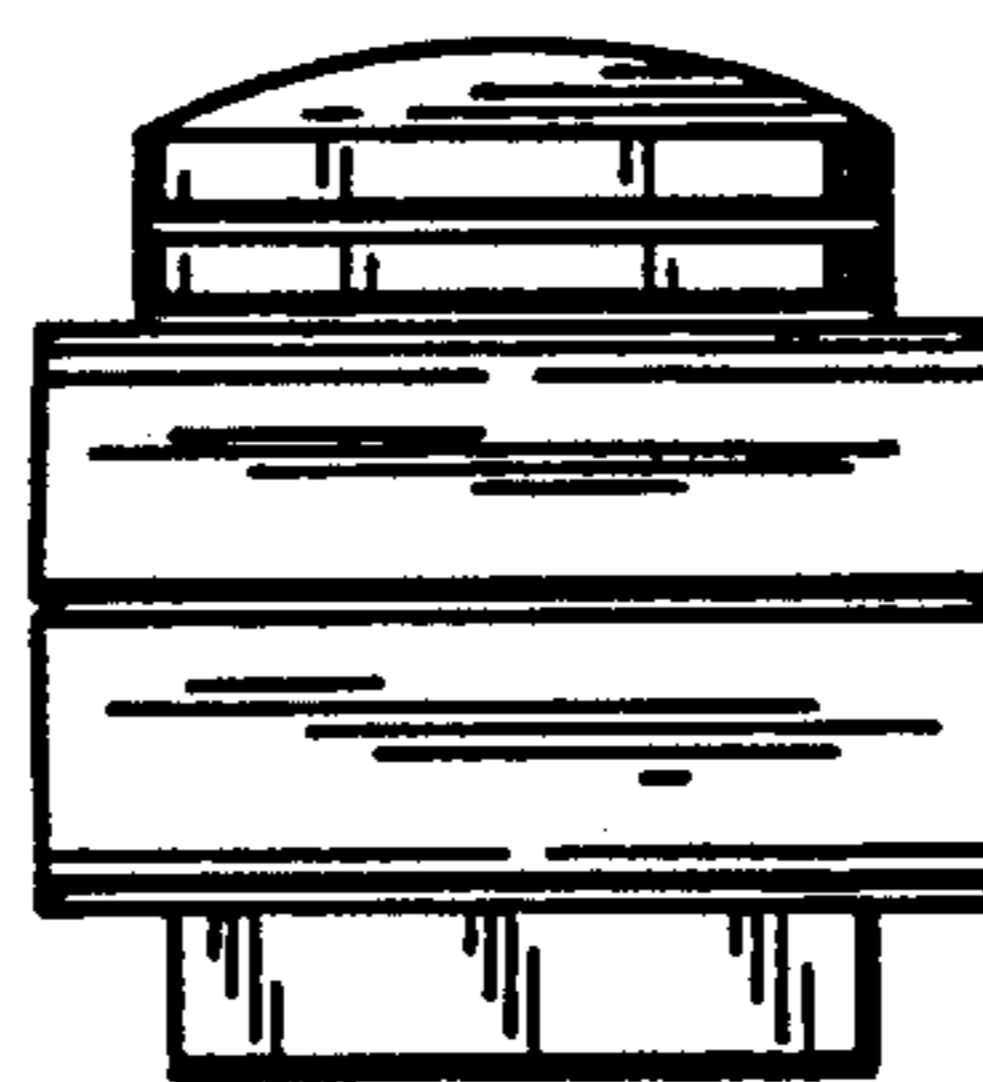

FIG. 7

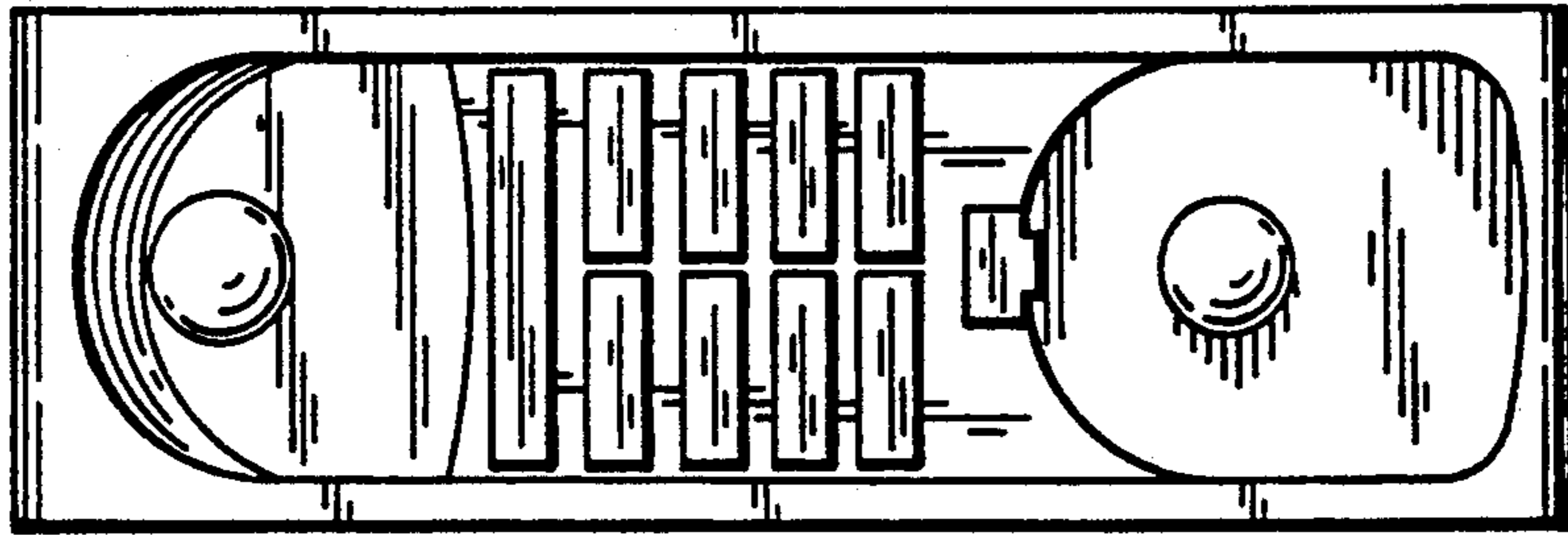

FIG. 8

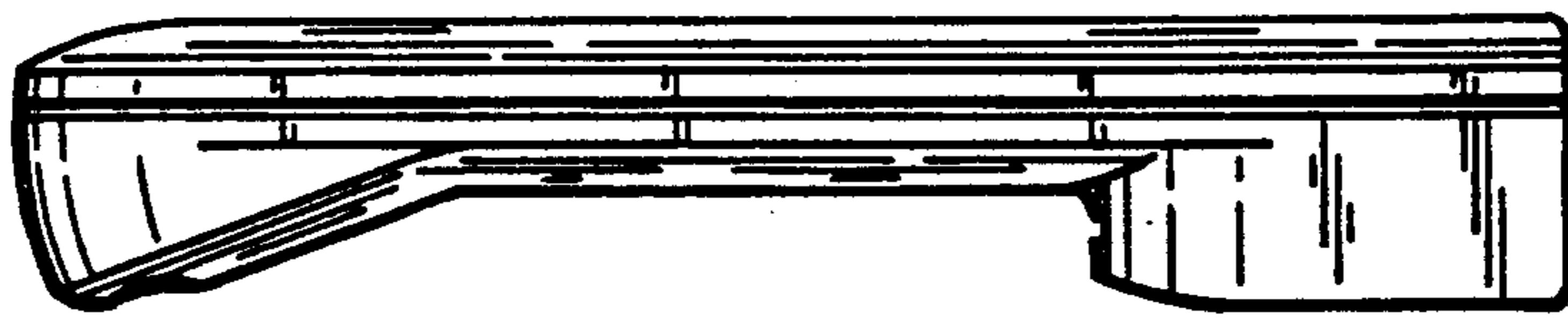

FIG. 9

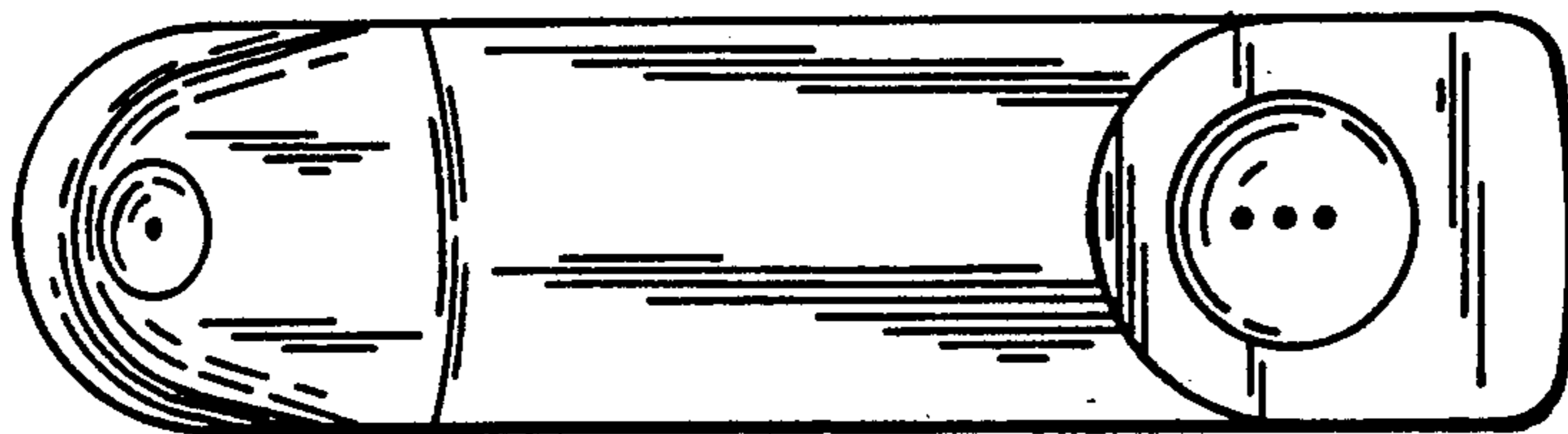

FIG. 10

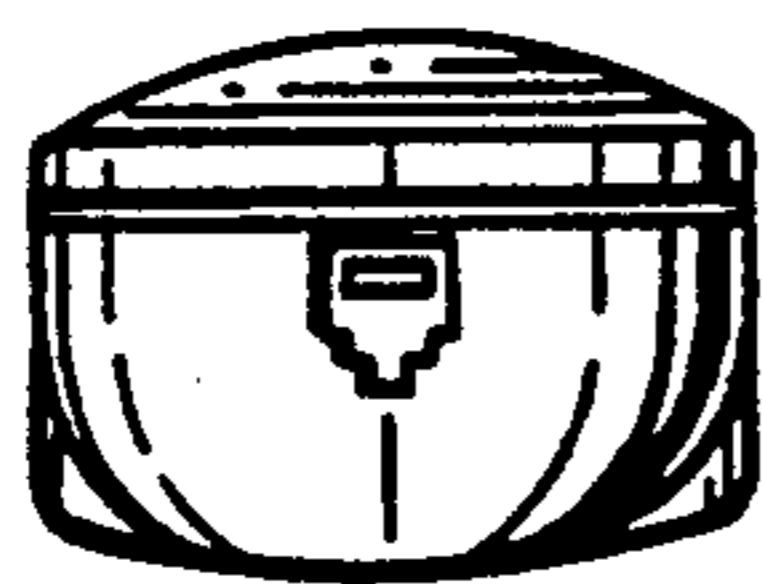

FIG. 11

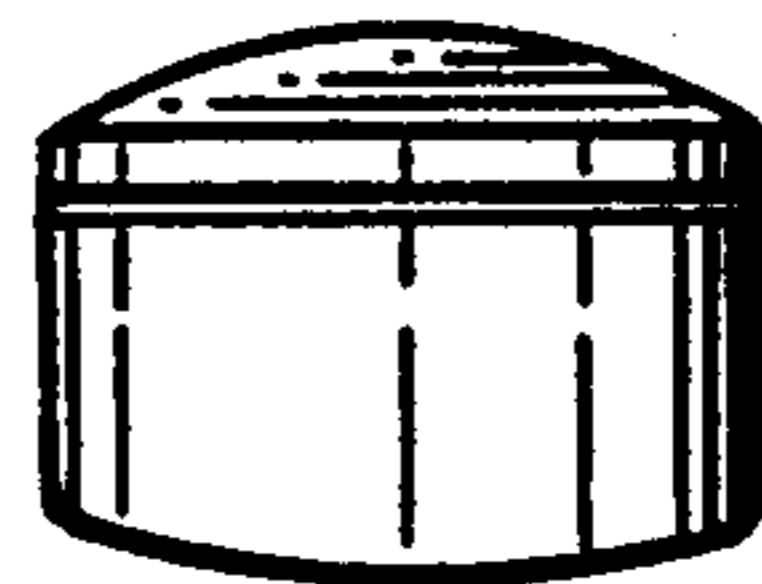

FIG. 12

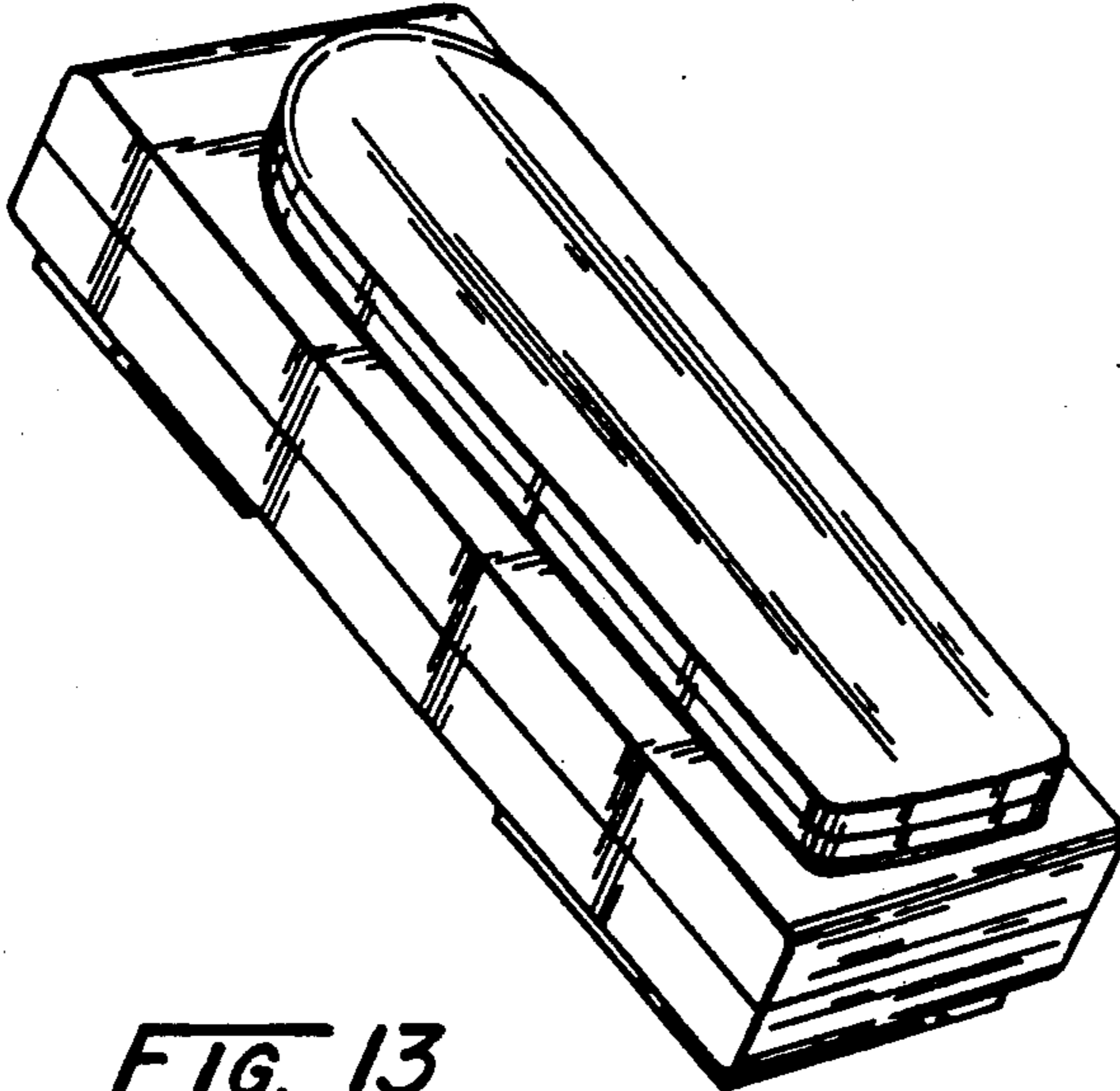

FIG. 13

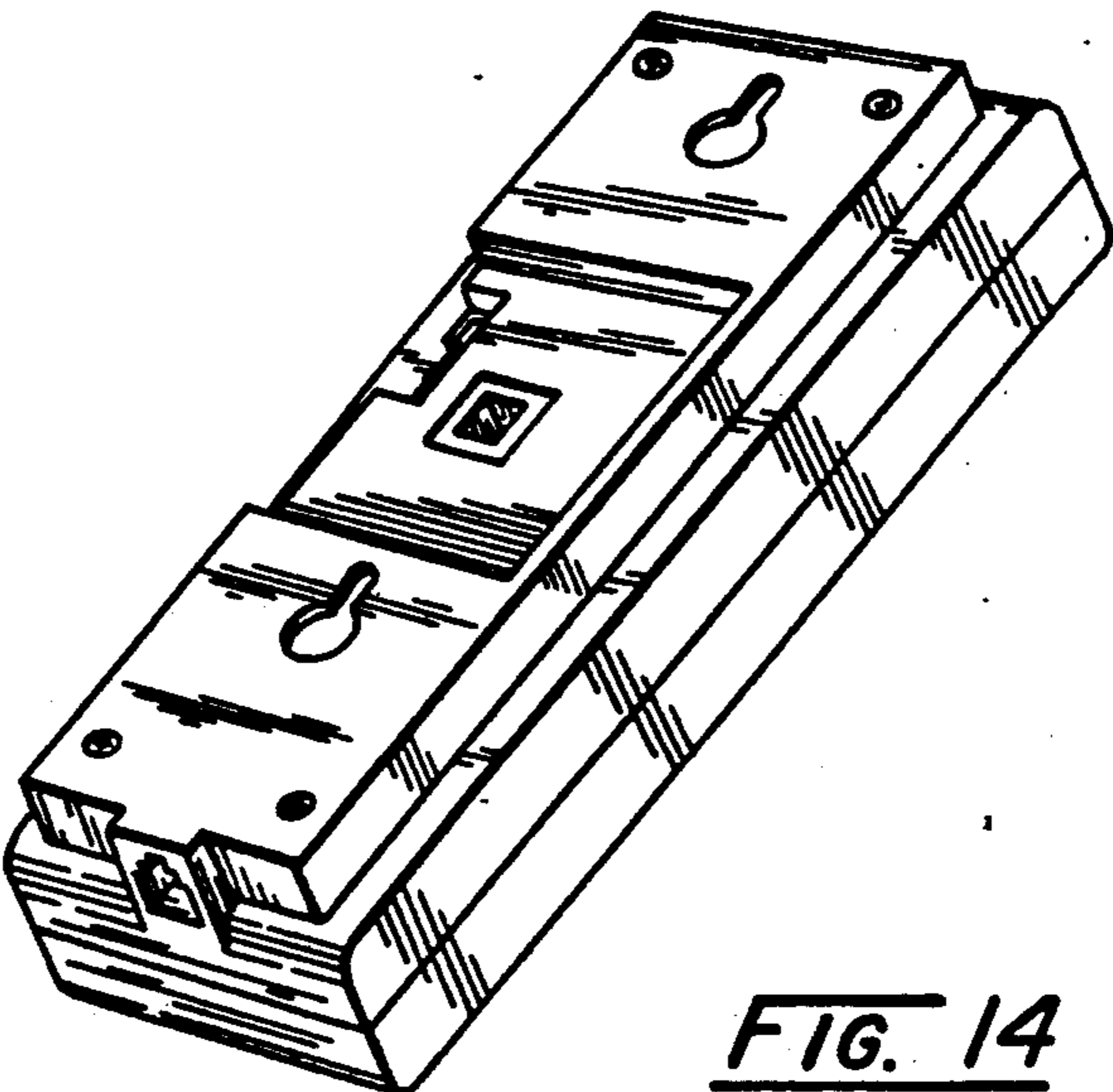

FIG. 14