



US00D333370S

United States Patent [19]

[11] Patent Number: **Des. 333,370**

Monk

[45] Date of Patent: **** Feb. 16, 1993**

[54] HUNTER'S CART

3,524,642 8/1970 Aguilar 280/47.3
3,870,333 3/1975 Burdick et al. 280/47.35

[76] Inventor: **Thomas J. Monk, 2202 Oregon Ave.,
Klamath Falls, Oreg. 97601**

Primary Examiner—Kay H. Chin
Attorney, Agent, or Firm—Leon Gilden

[**] Term: **14 Years**

[57] **CLAIM**

[21] Appl. No.: **677,853**

The ornamental design for a hunter's cart, as shown and described.

[22] Filed: **Apr. 1, 1991**

[52] U.S. Cl. **D34/12; D34/16**

DESCRIPTION

[58] Field of Search **D34/12, 24, 16, 23;
280/47.26, 652, 47.3, 79.1, 47.35**

FIG. 1 is a front elevational view of the hunter's cart showing my new design;

FIG. 2 is a rear elevational view thereof;

FIG. 3 is a left side elevational view thereof;

FIG. 4 is a right side elevational view thereof;

FIG. 5 is a top plan view thereof;

FIG. 6 is a bottom plan view thereof; and,

FIG. 7 is a top and front perspective view thereof.

[56]

References Cited

U.S. PATENT DOCUMENTS

D. 283,071 3/1986 Neuhaus D34/24
2,979,338 4/1961 Dwyer 280/47.3
2,992,834 7/1961 Tidwell et al. 280/47.3

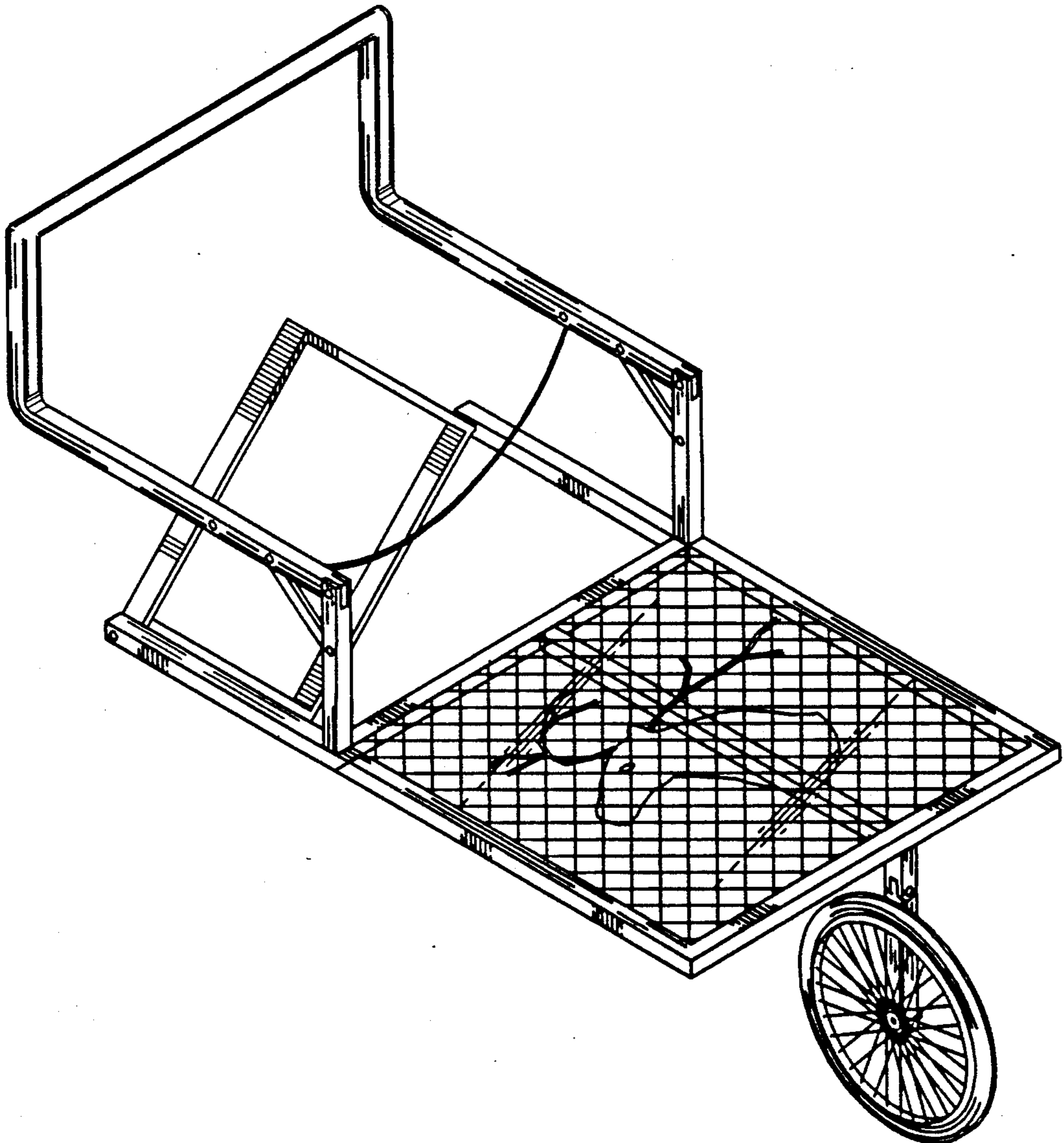

FIG. 1

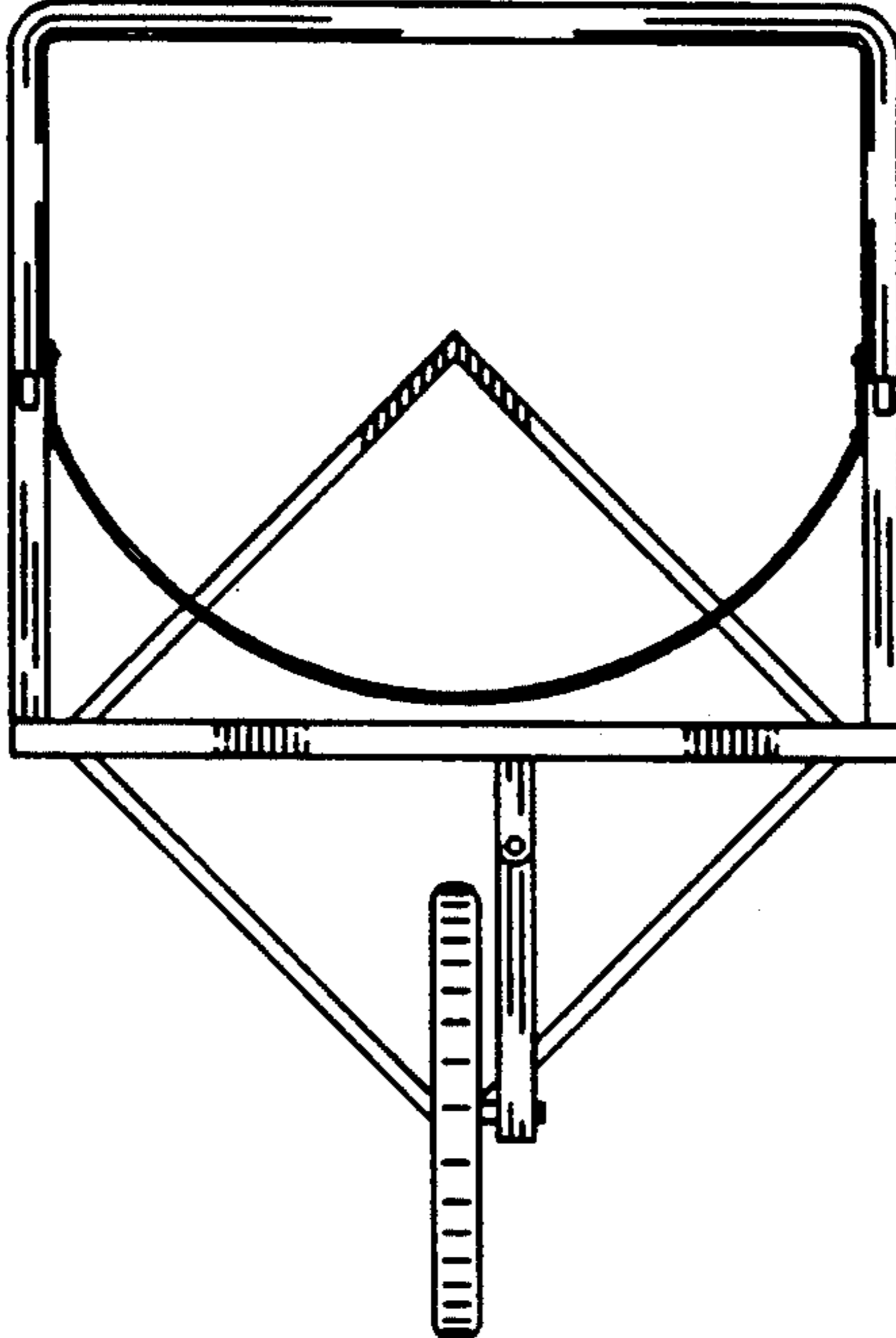

FIG. 2

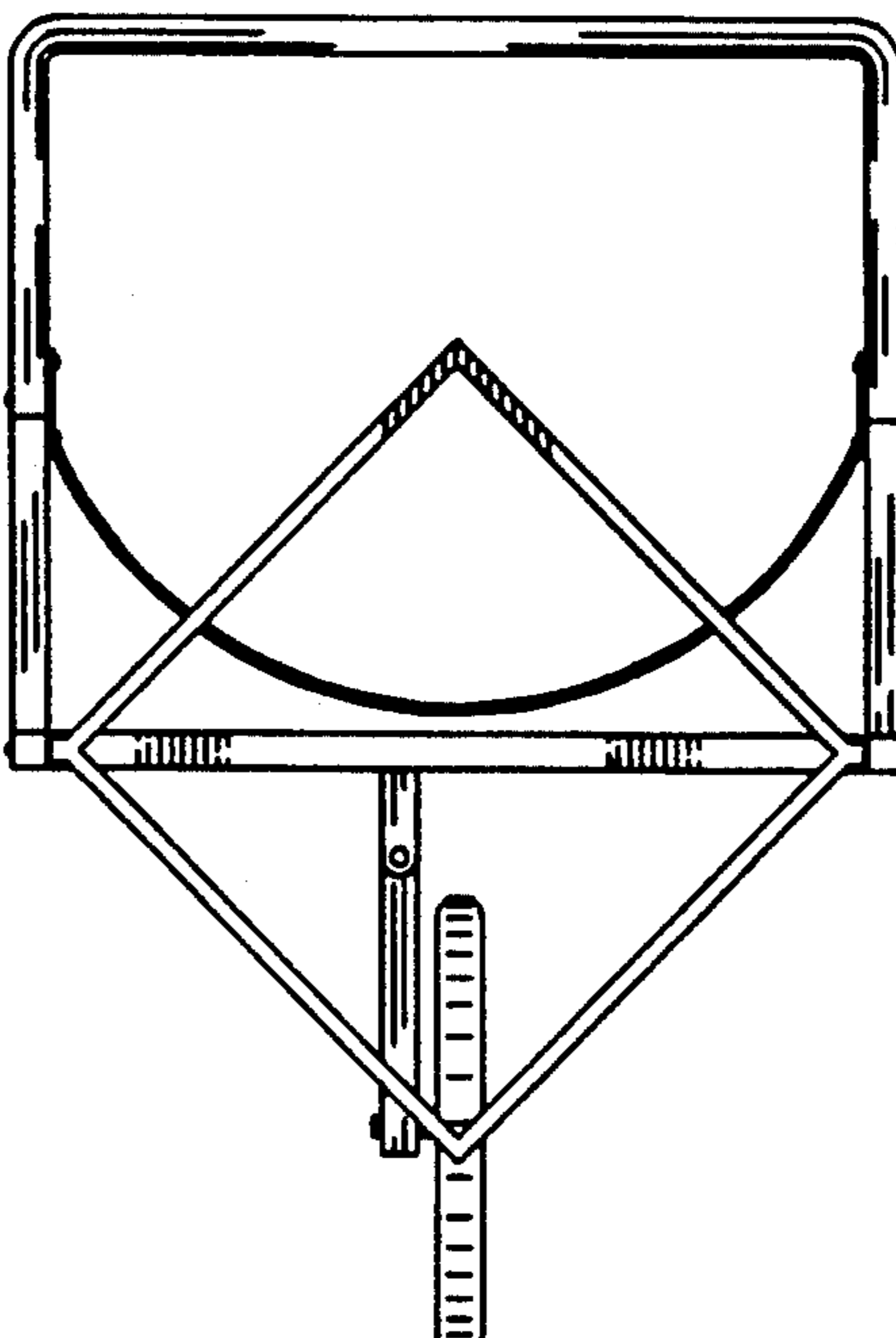

FIG. 3

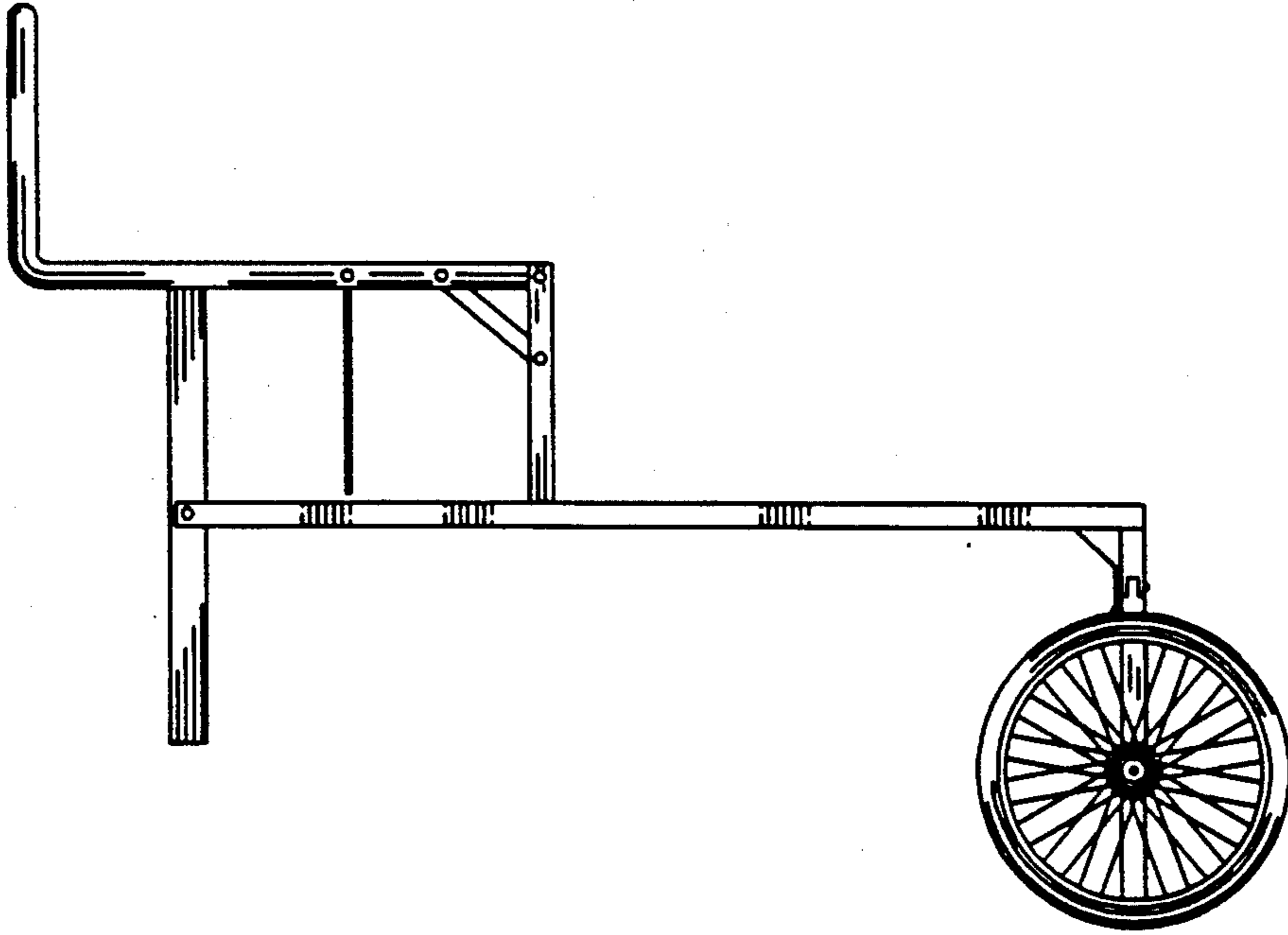

FIG. 4

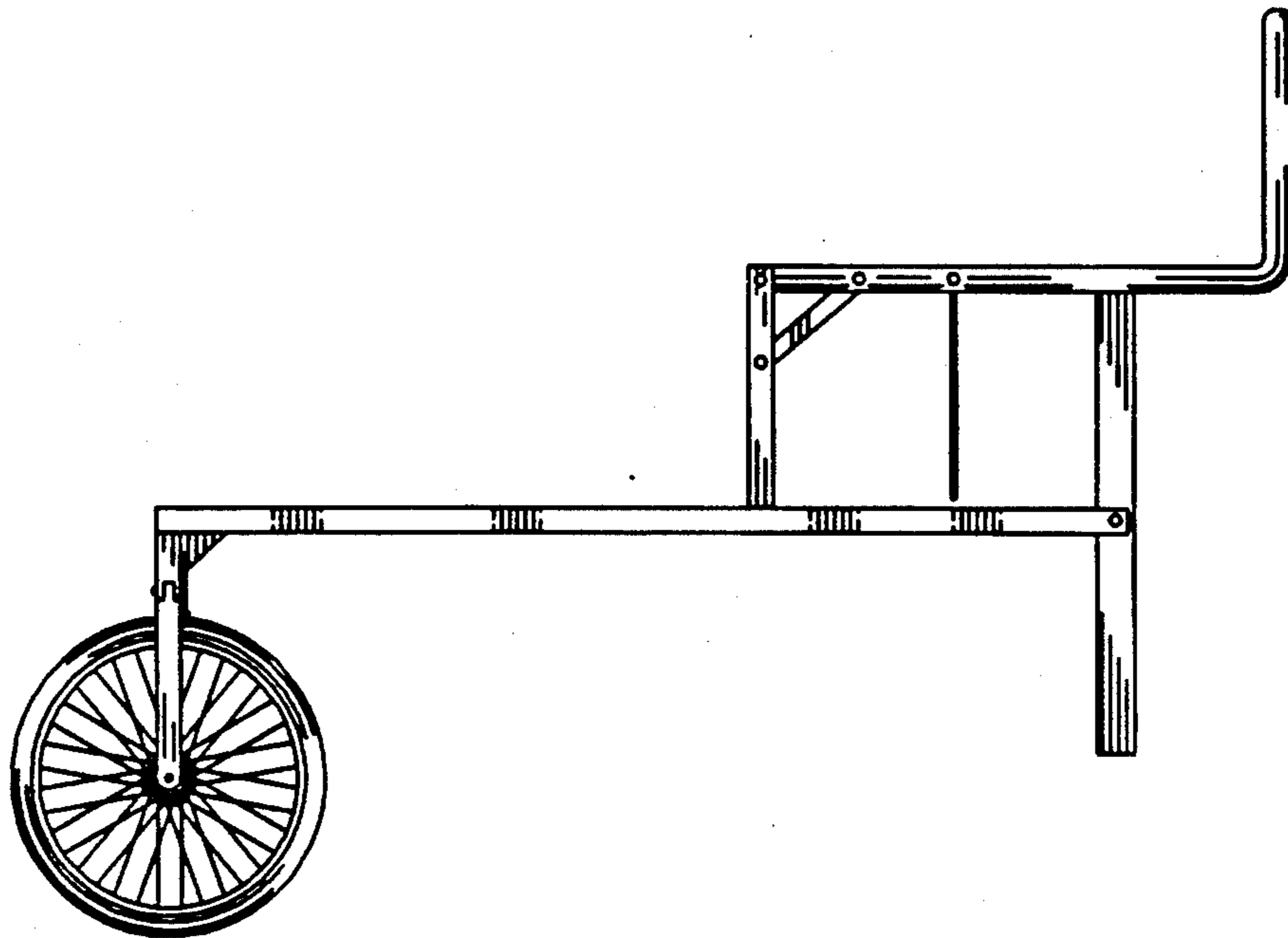

FIG. 5

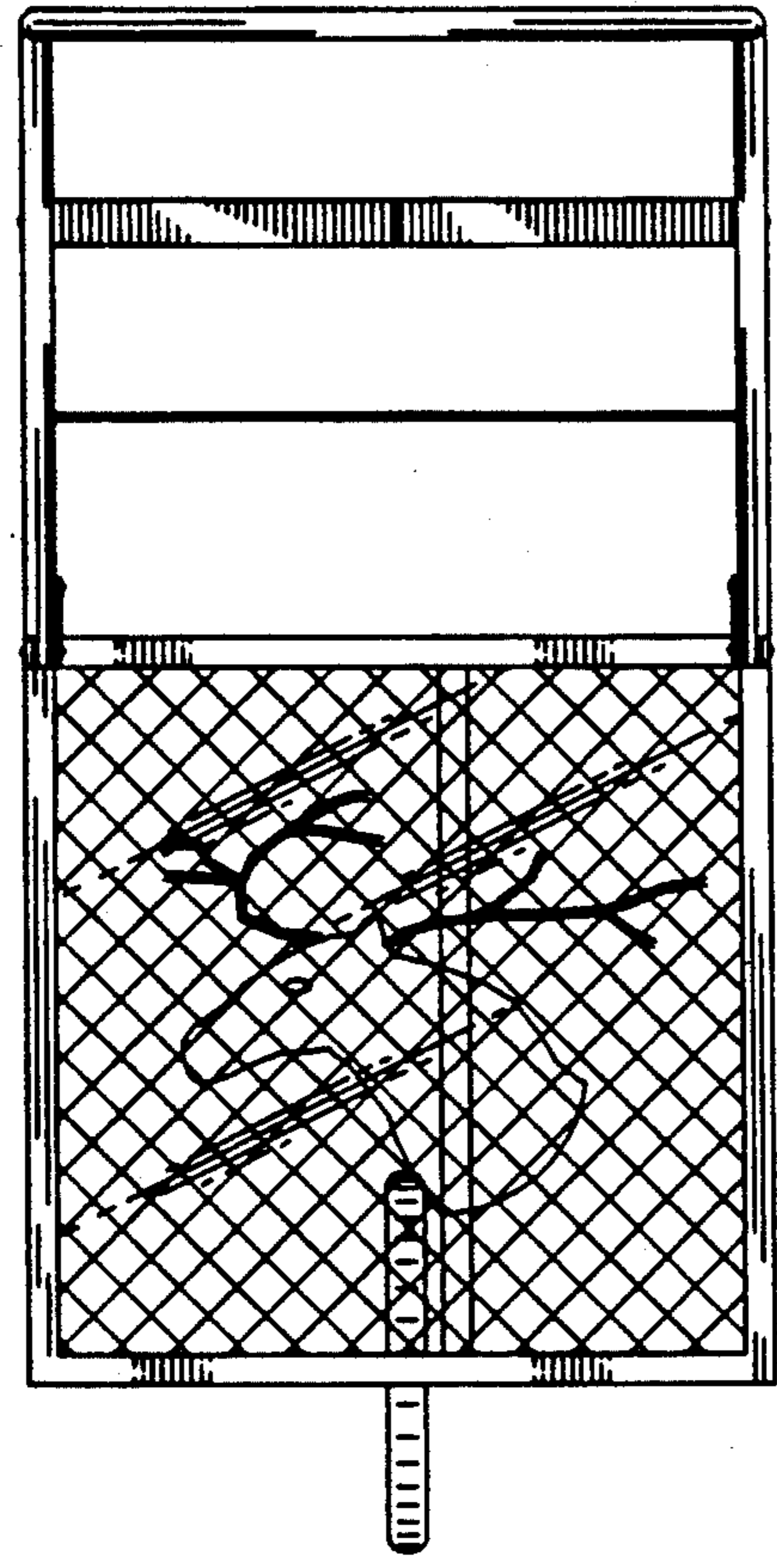

FIG. 6

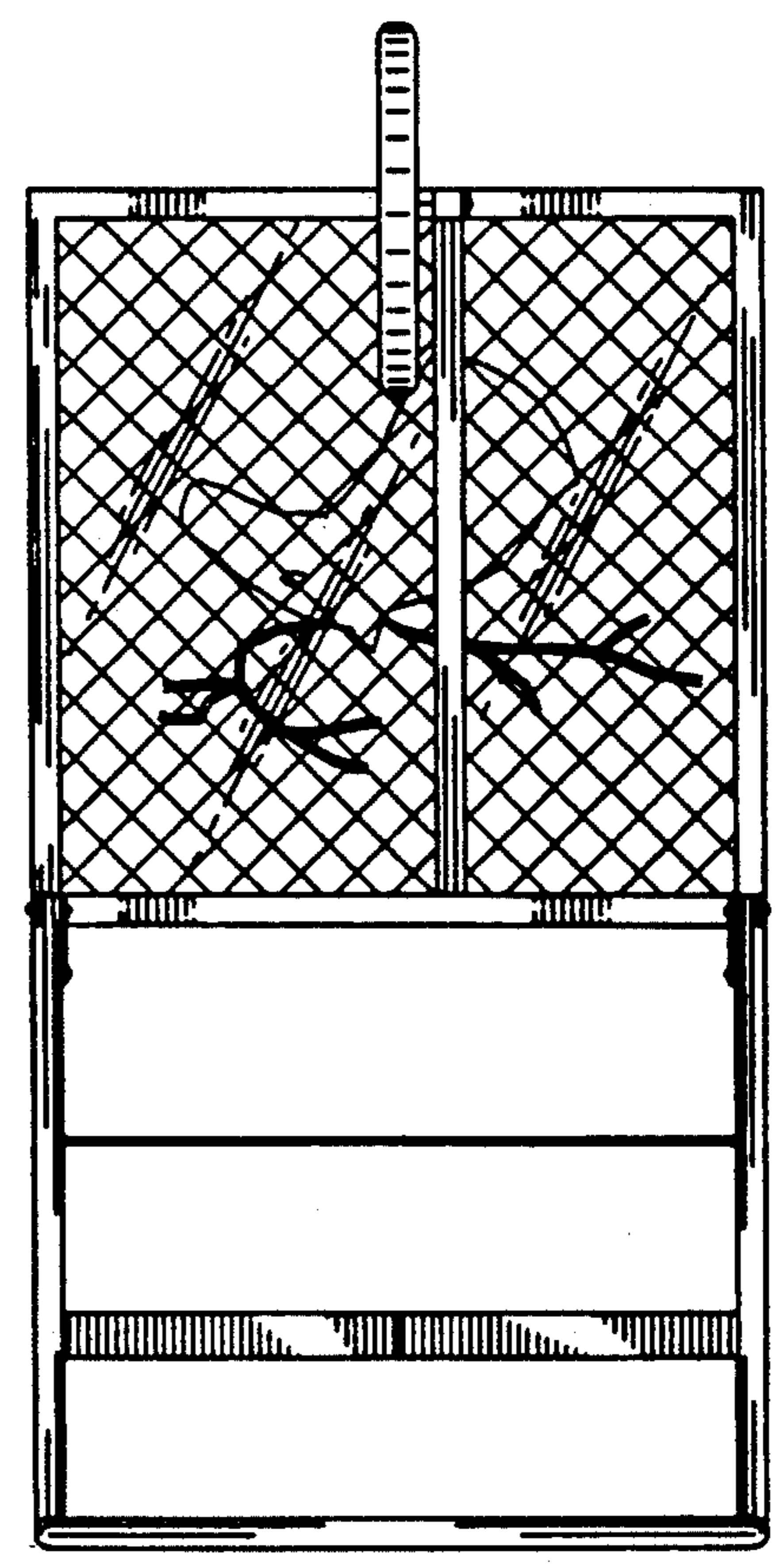

FIG. 7

