



US00D333348S

United States Patent [19]
Yokomachi

[11] **Patent Number: Des. 333,348**

[45] **Date of Patent: ** Feb. 16, 1993**

[54] **ANESTHESIA SOLUTION FILTER**

[75] **Inventor: Shinsuke Yokomachi, Fujinomiya, Japan**

[73] **Assignee: Terumo Kabushiki Kaisha, Tokyo, Japan**

[**] **Term: 14 Years**

[21] **Appl. No.: 556,792**

[22] **Filed: Jul. 20, 1990**

[30] **Foreign Application Priority Data**

Jan. 25, 1990 [JP] Japan 2-1695

[52] **U.S. Cl. D24/162**

[58] **Field of Search D24/161, 164, 169;
210/445, 446, 436, 448, 493.1, 447, 188, 321.84;
604/406; 606/200, 191**

[56] **References Cited**

U.S. PATENT DOCUMENTS

- D. 319,504 8/1991 Sone et al. D24/162
- D. 328,493 8/1992 Kuroda et al. D24/162
- 4,304,670 12/1981 Watanabe et al. D24/162 X
- 4,341,538 7/1982 Vadnay et al. 210/445 X

Primary Examiner—Stella Reid

Attorney, Agent, or Firm—Frishauf, Holtz, Goodman & Woodward

[57] **CLAIM**

The ornamental design for an anesthesia solution filter, as shown.

DESCRIPTION

FIG. 1 is a perspective view of an anesthesia solution filter, showing my new design;
 FIG. 2 is a front elevational view thereof;
 FIG. 3 is a rear elevational view thereof;
 FIG. 4 is a top plan view thereof;
 FIG. 5 is a bottom plan view thereof;
 FIG. 6 is a right side elevational view thereof;
 FIG. 7 is a left side elevational view thereof;
 FIG. 8 is a cross-sectional view taken along line 8—8 of FIG. 2;
 FIG. 9 is a cross-sectional view taken along line 9—9 of FIG. 2;
 FIG. 10 is a perspective view of a second embodiment of the anesthesia solution filter, showing my new design;
 FIG. 11 is a front elevational view thereof;
 FIG. 12 is a rear elevational view thereof;
 FIG. 13 is a top plan view thereof;
 FIG. 14 is a bottom plan view thereof;
 FIG. 15 is a right side elevational view thereof;
 FIG. 16 is a left side elevational view thereof;
 FIG. 17 is a cross-sectional view taken along line 17—17 of FIG. 11; and,
 FIG. 18 is a cross-sectional view taken along line 18—18 of FIG. 11.

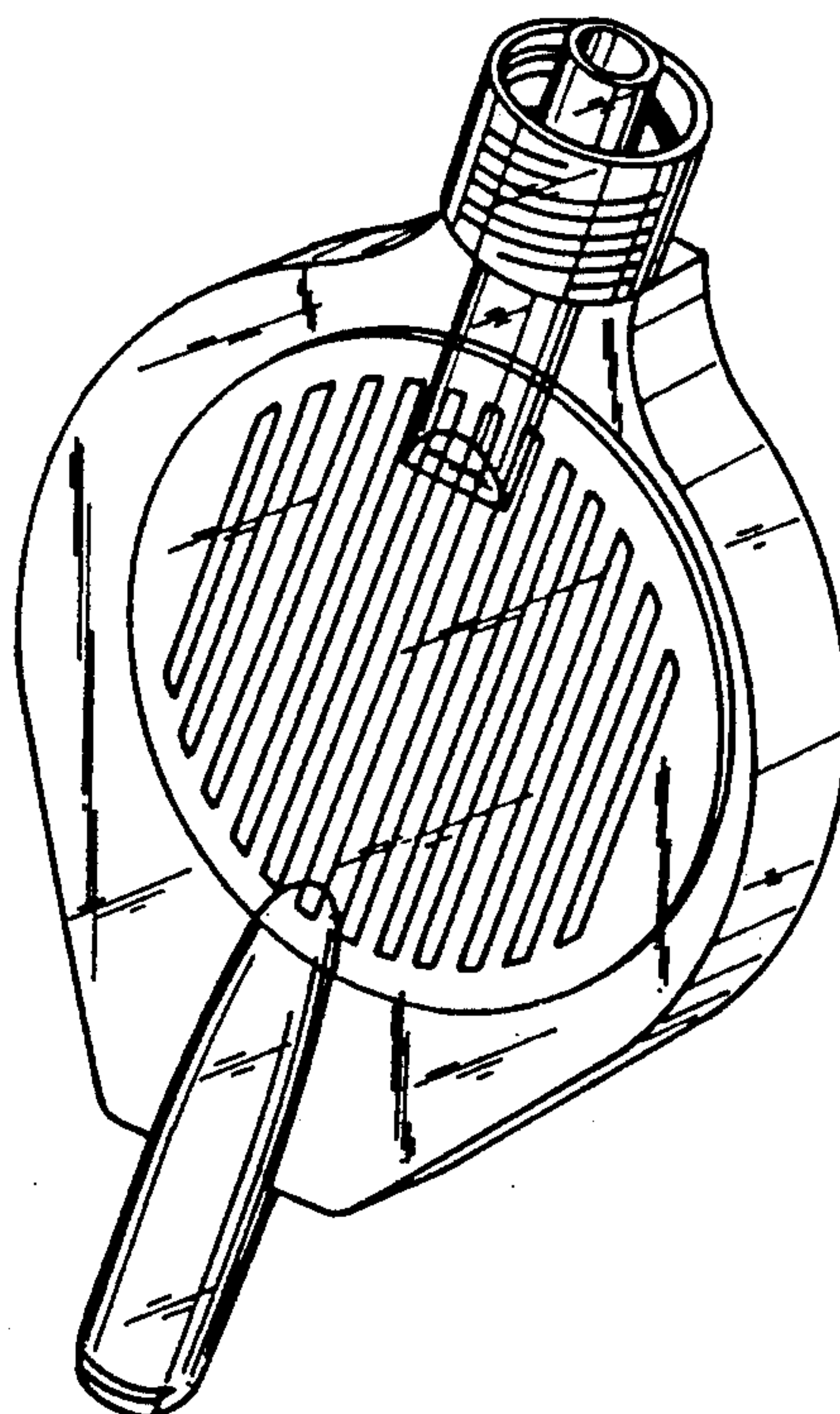
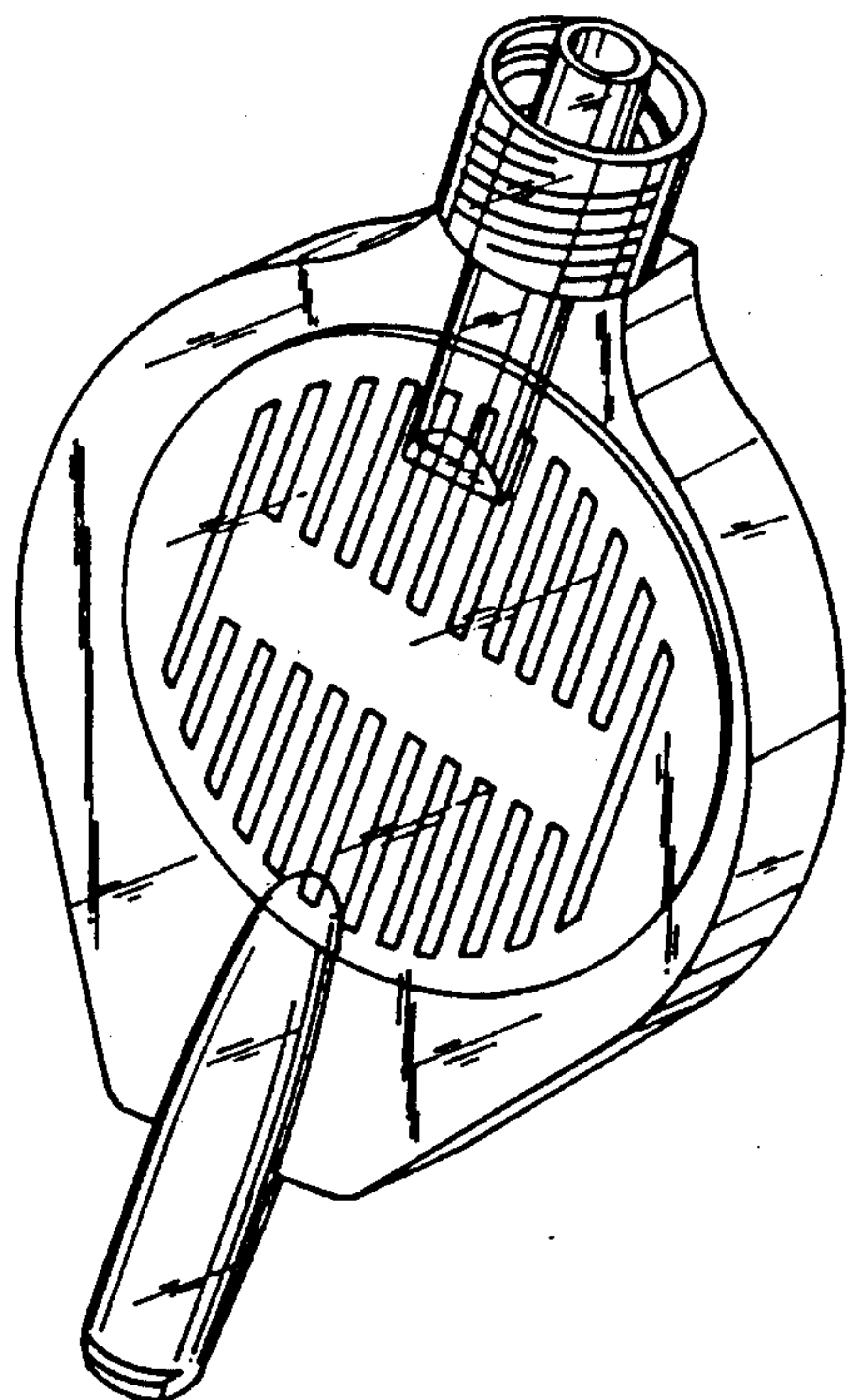

FIG. 1

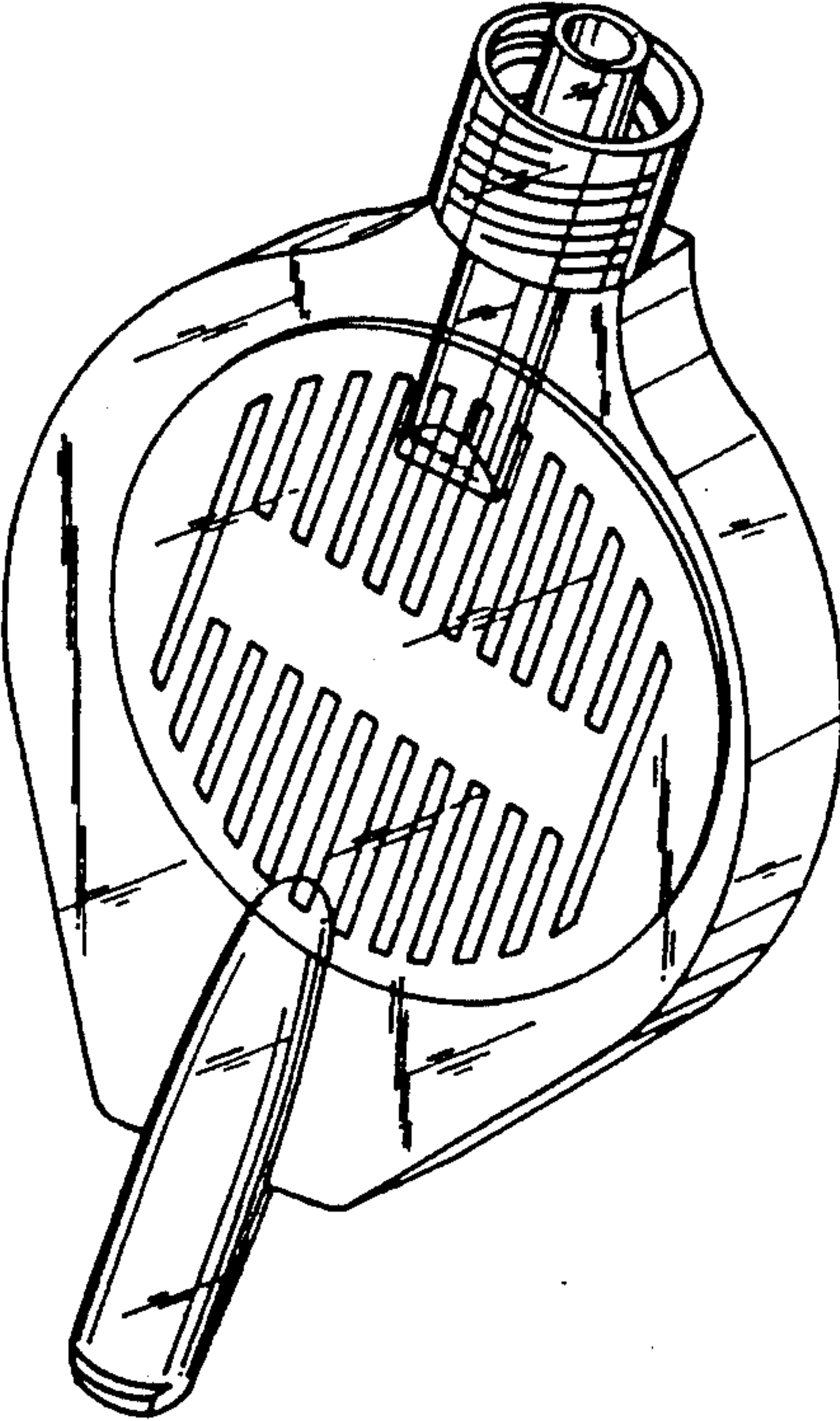

FIG. 2

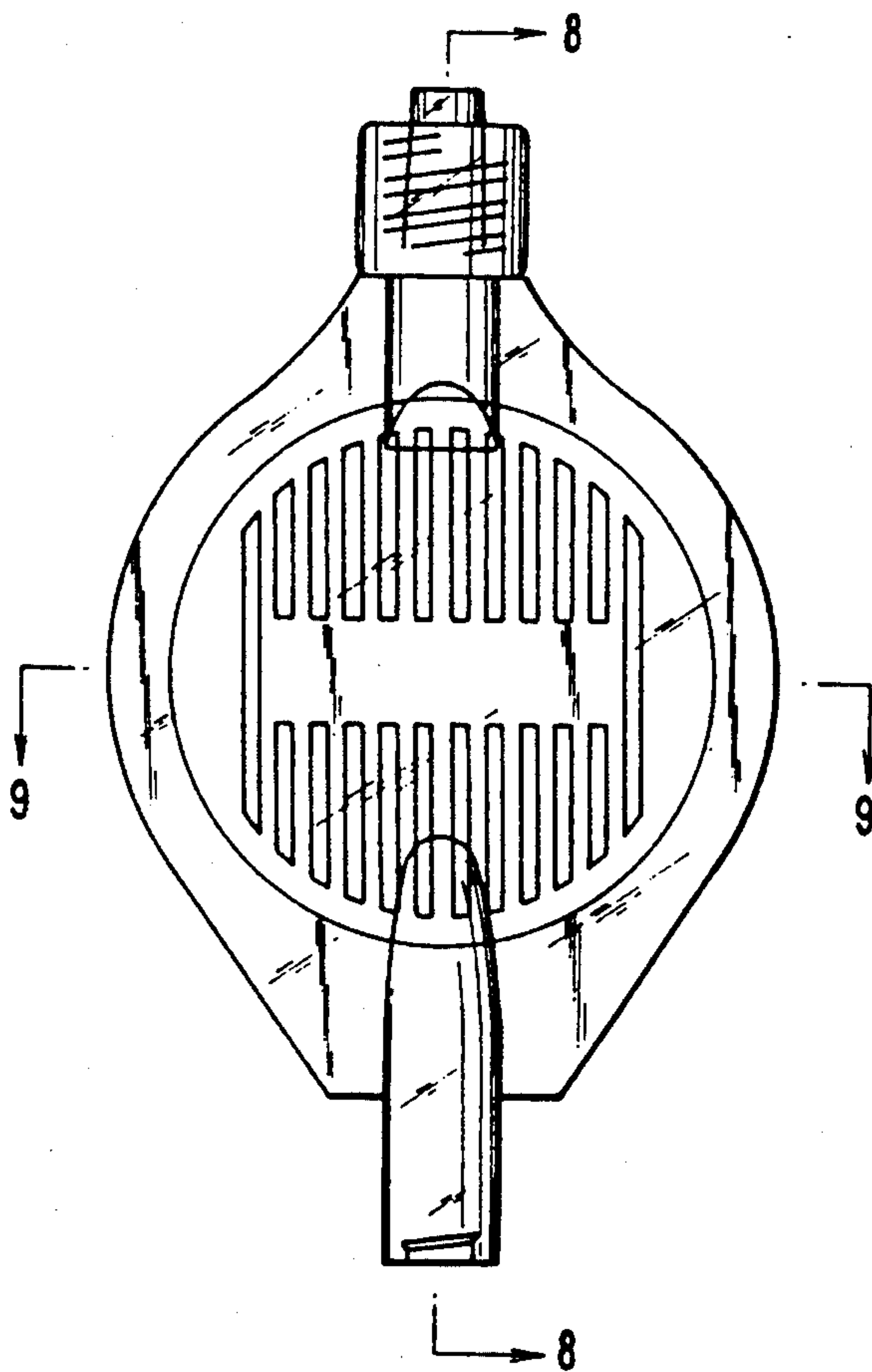

FIG. 3

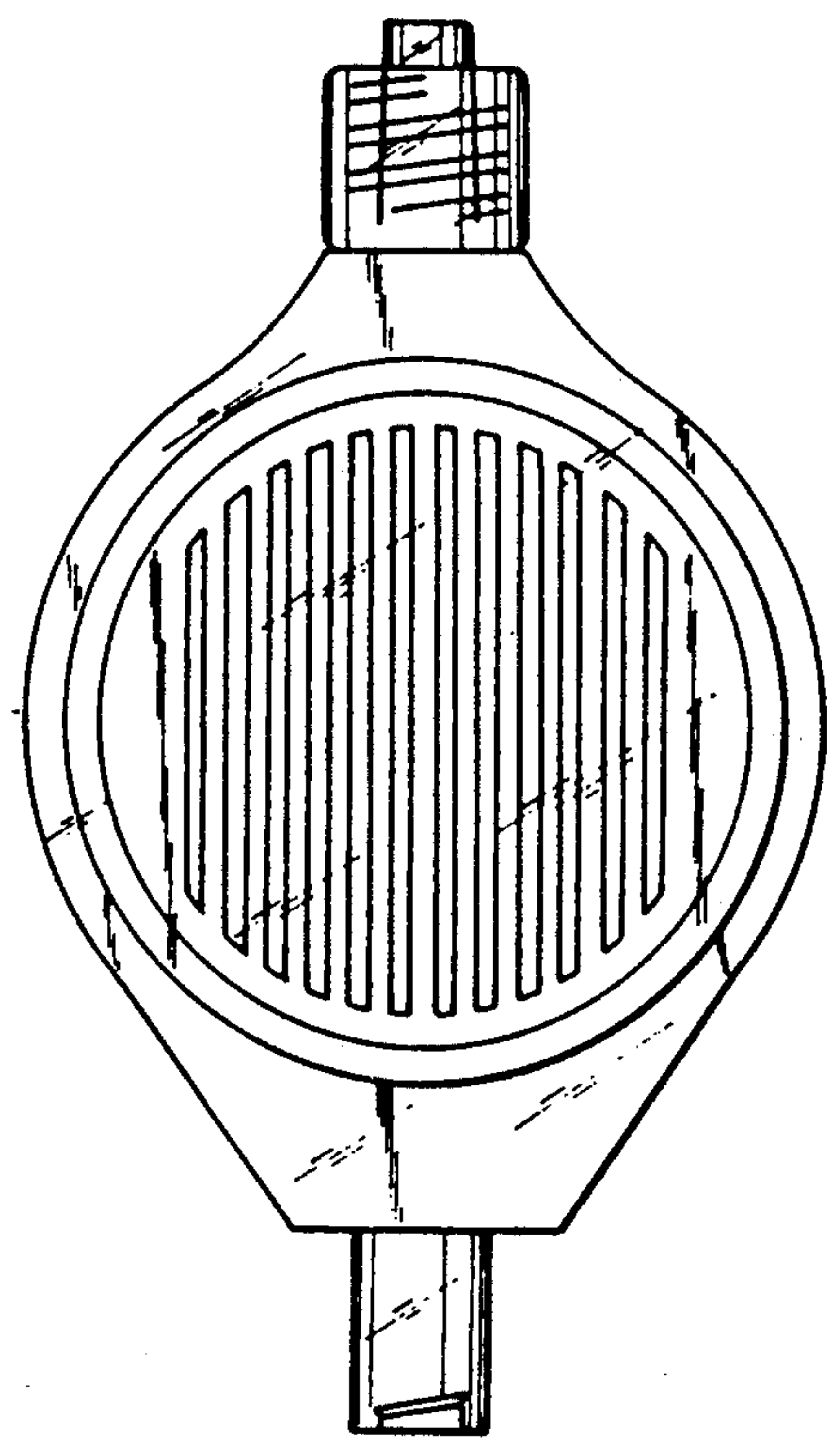

FIG. 4

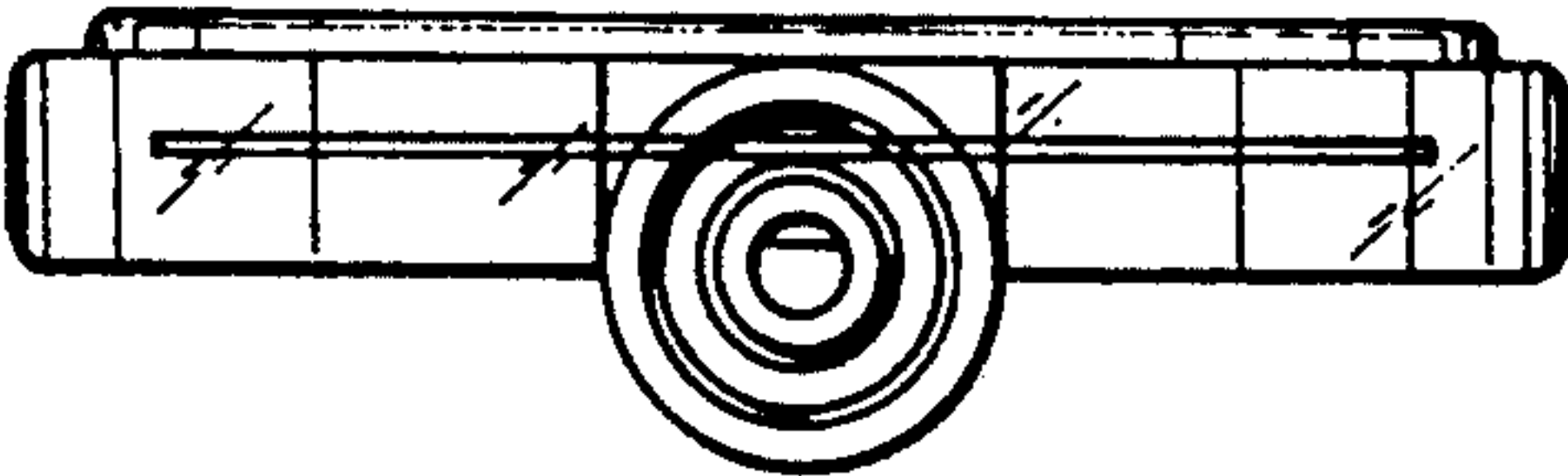

FIG. 5

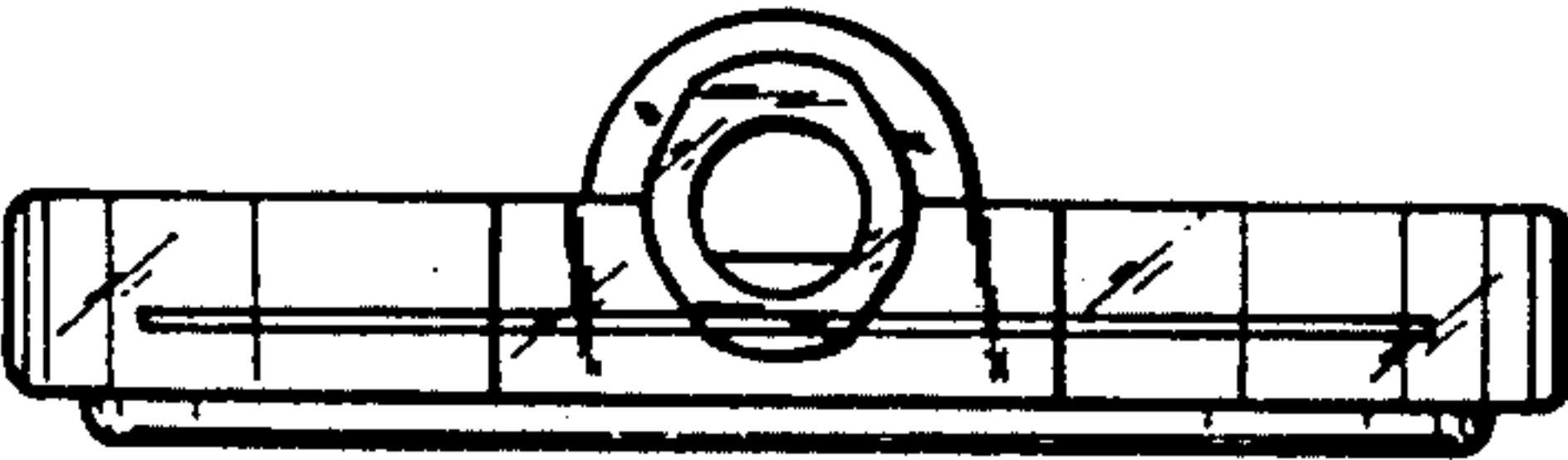

FIG. 6

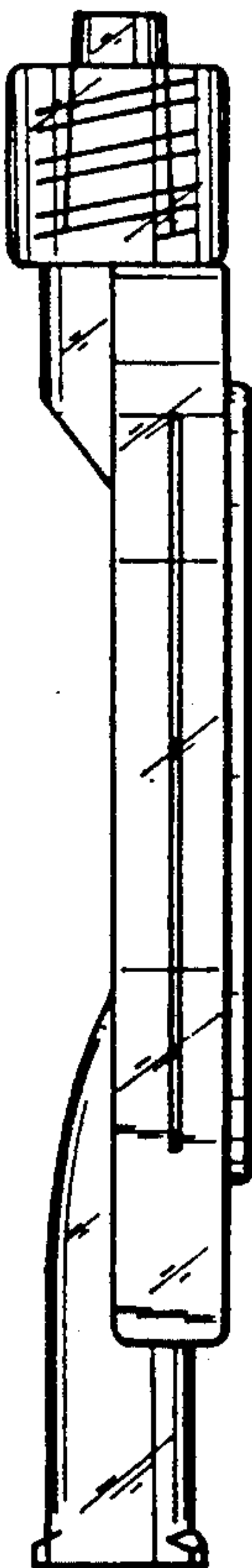

FIG. 7



FIG. 8

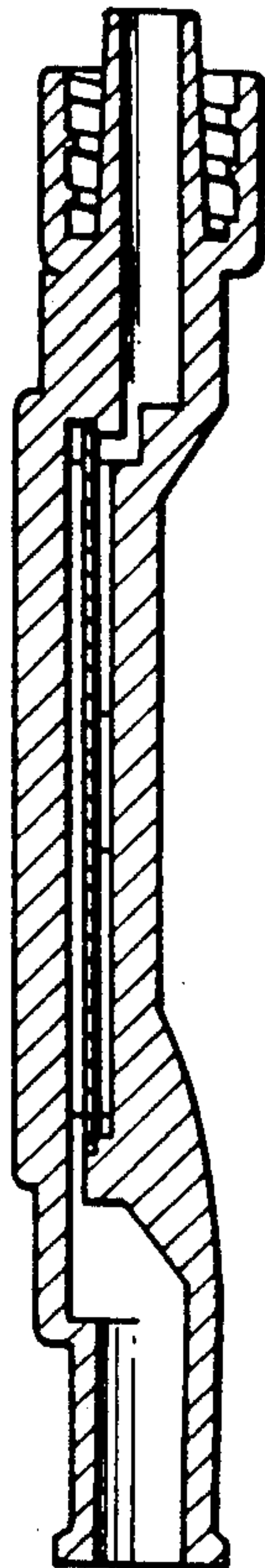

FIG. 9

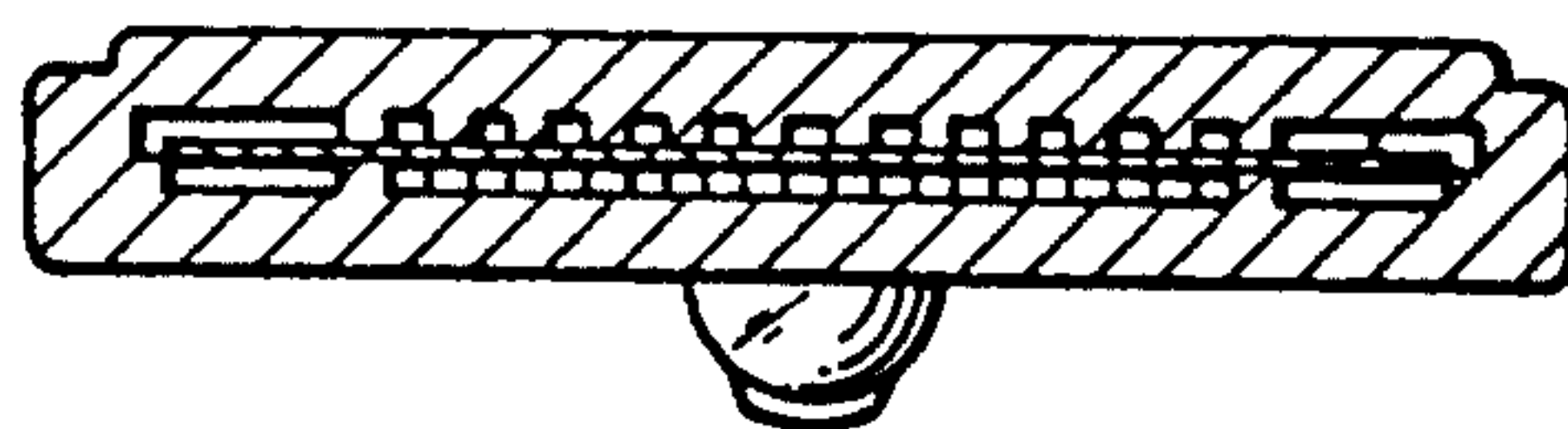

FIG. 10

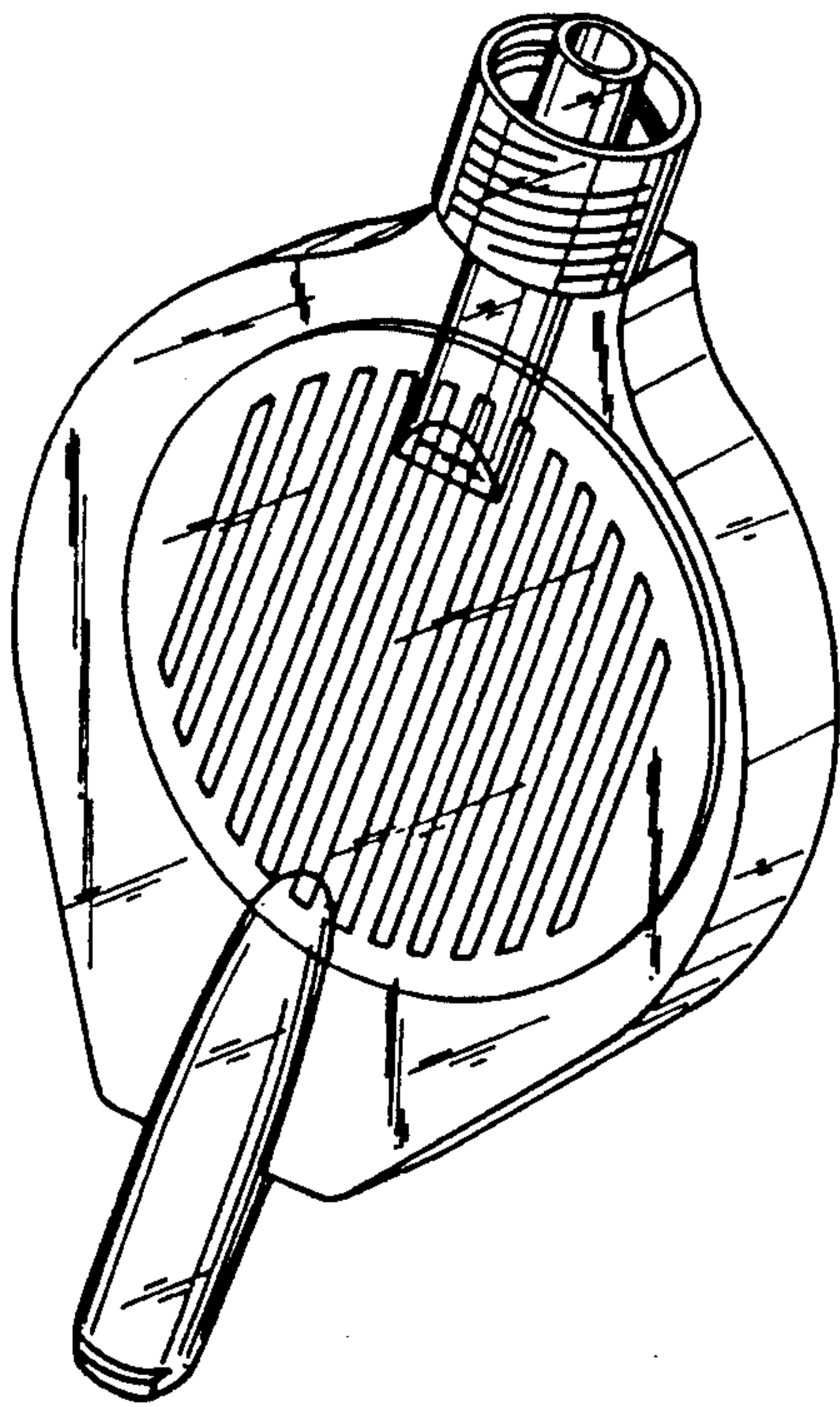

FIG. 11

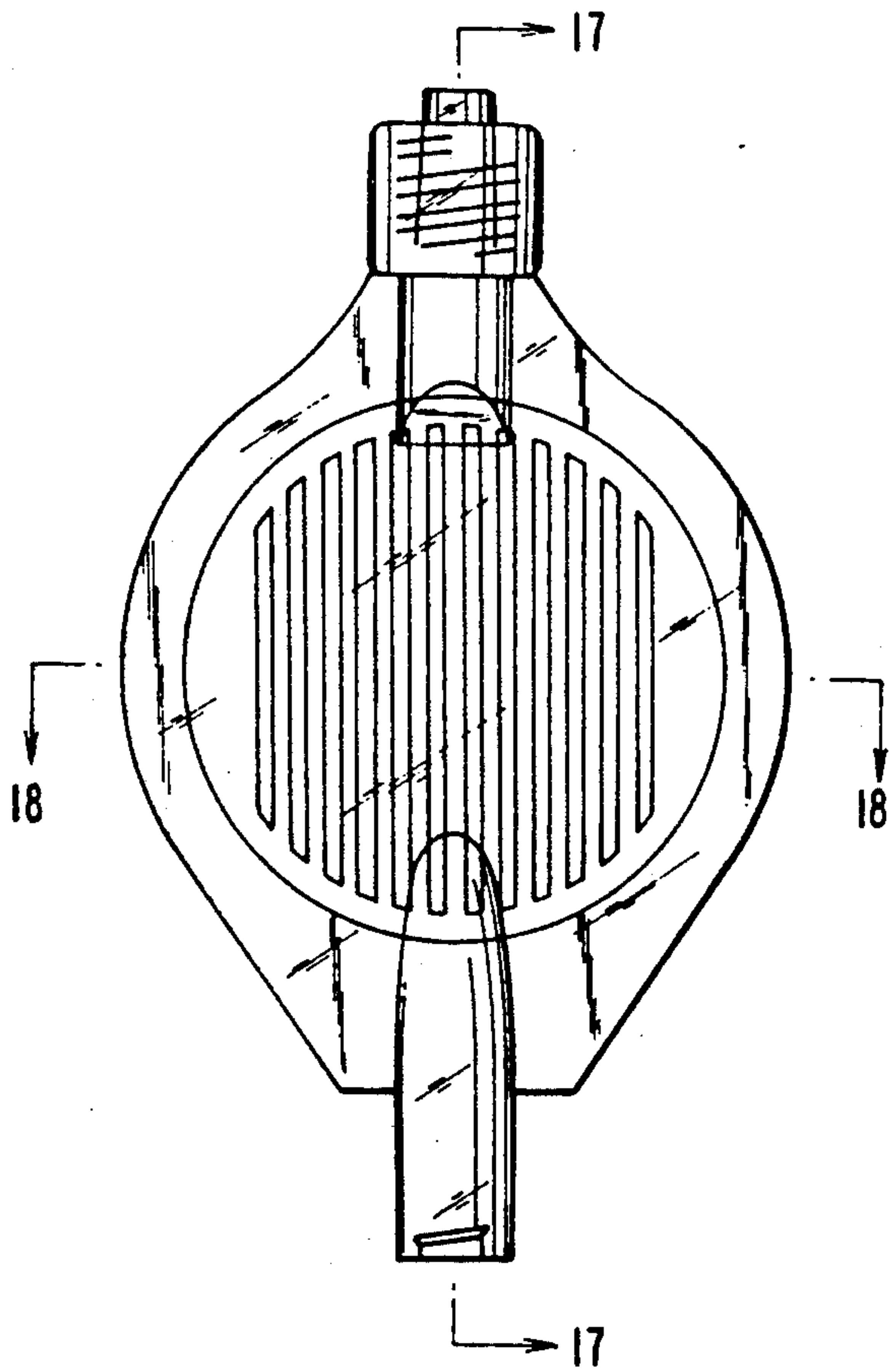

FIG. 12

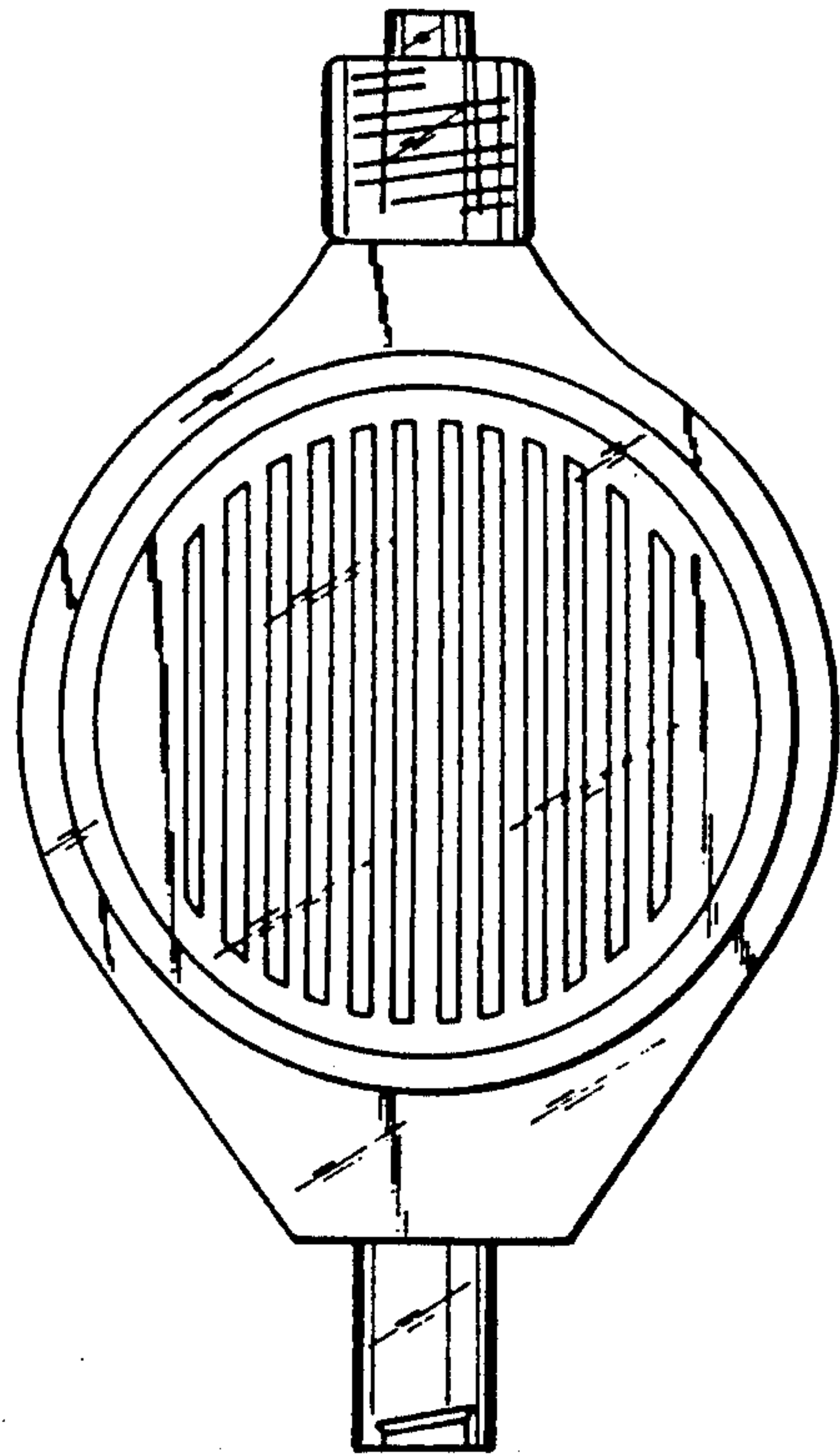

FIG. 13

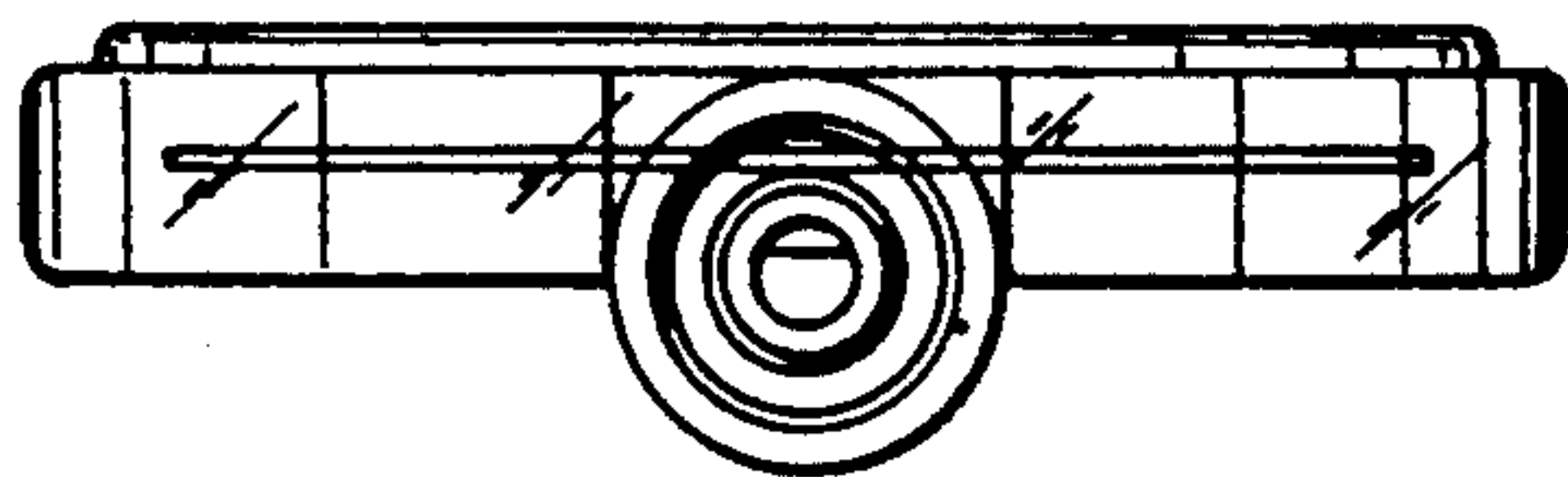

FIG. 14

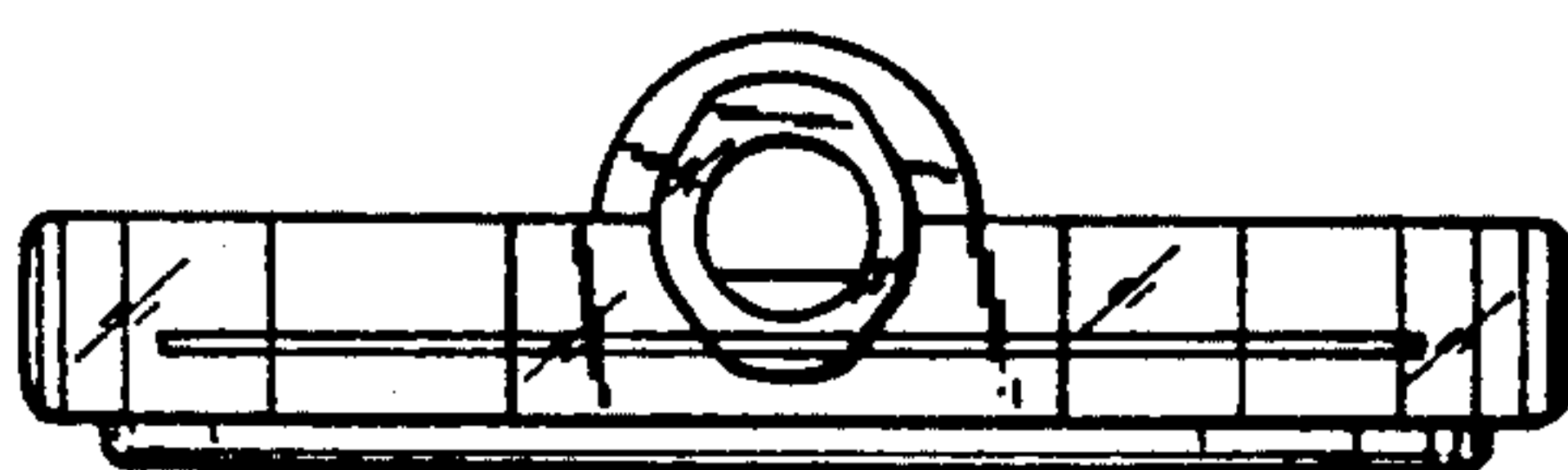

FIG. 15



FIG. 16



FIG. 17

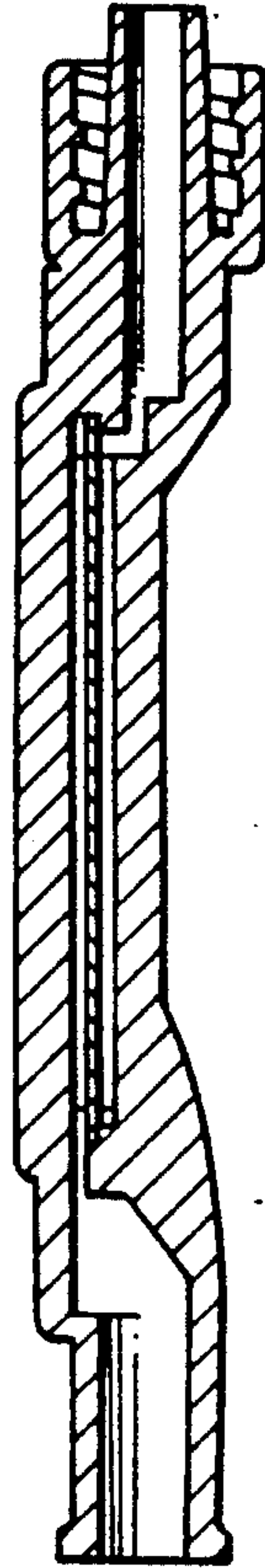

FIG. 18

