



US00D333305S

United States Patent [19]
West

[11] **Patent Number: Des. 333,305**
[45] **Date of Patent: ** Feb. 16, 1993**

[54] **HEADSET TELEPHONE**

[76] **Inventor: David H. West, 353 Mammoth Rd.,
Apt. B, Manchester, N.H. 03103**

[**] **Term: 14 Years**

[21] **Appl. No.: 705,891**

[22] **Filed: May 28, 1990**

[52] **U.S. Cl. D14/223; D14/205;
D14/247; D14/252; D14/138**

[58] **Field of Search D14/147, 205, 206, 223;
379/61, 446, 440**

D. 321,350 11/1991 Phelan D14/205
4,694,484 9/1987 Atkinson et al. 379/58
4,878,237 10/1989 Cianflone 379/416 X
4,882,745 11/1989 Silver 379/61

*Primary Examiner—Horace B. Fay, Jr.
Attorney, Agent, or Firm—Leon Gilden*

[56] **References Cited**

U.S. PATENT DOCUMENTS

D. 292,400 10/1987 Koggs et al. D14/206 X
D. 302,429 2/1989 Leer D14/266 X
D. 305,759 1/1990 Balbuena D14/147
D. 306,167 2/1990 Johnson, Jr. et al. D14/205 X

[57] **CLAIM**

The ornamental design for a headset telephone, as shown and described.

DESCRIPTION

FIG. 1 is a front elevational view of a headset telephone showing my new design;
FIG. 2 is a rear elevational view thereof;
FIGS. 3 and 4 are respectively left and right side elevational views thereof; and,
FIGS. 5 and 6 respectively top and bottom plan views thereof.

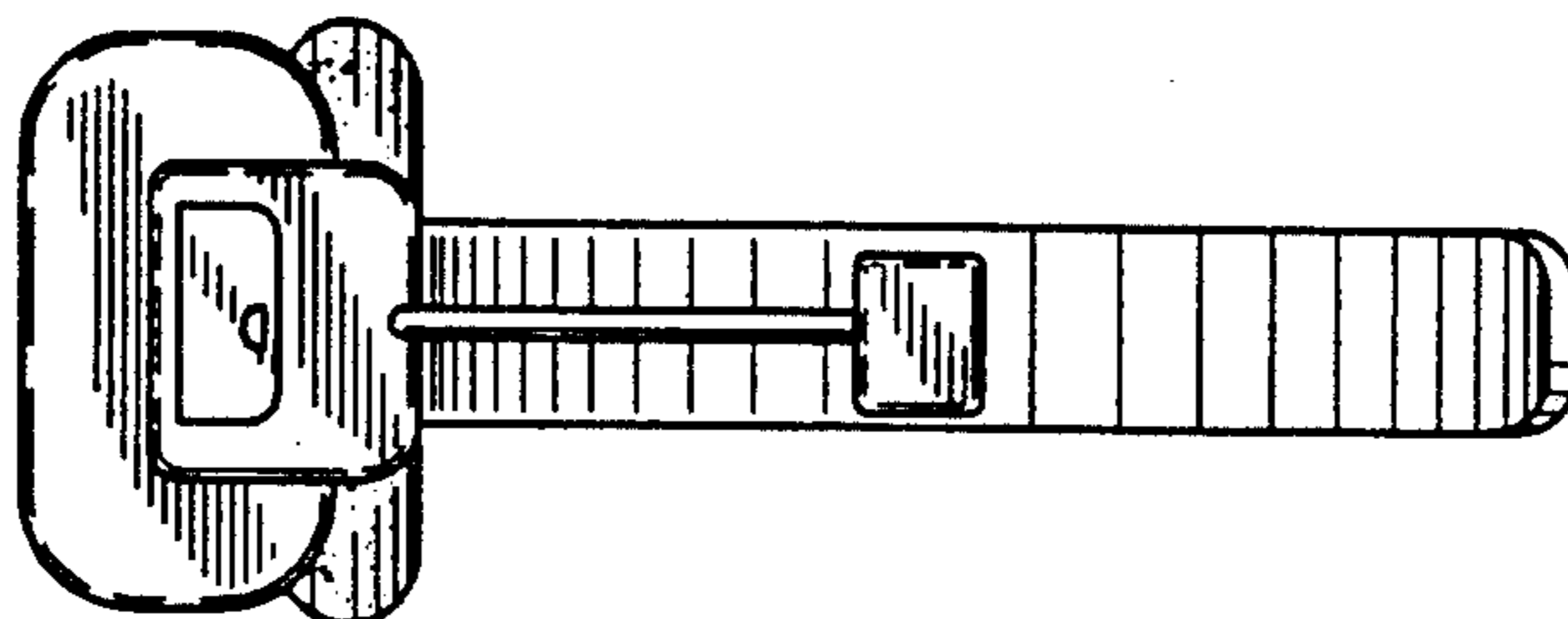
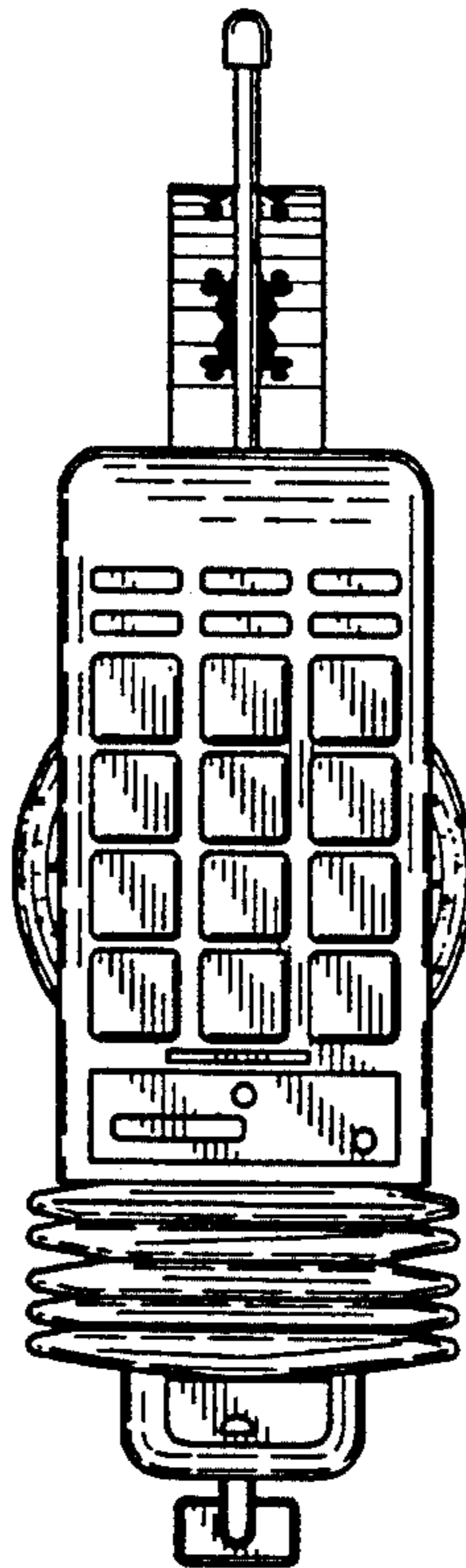

FIG. 1

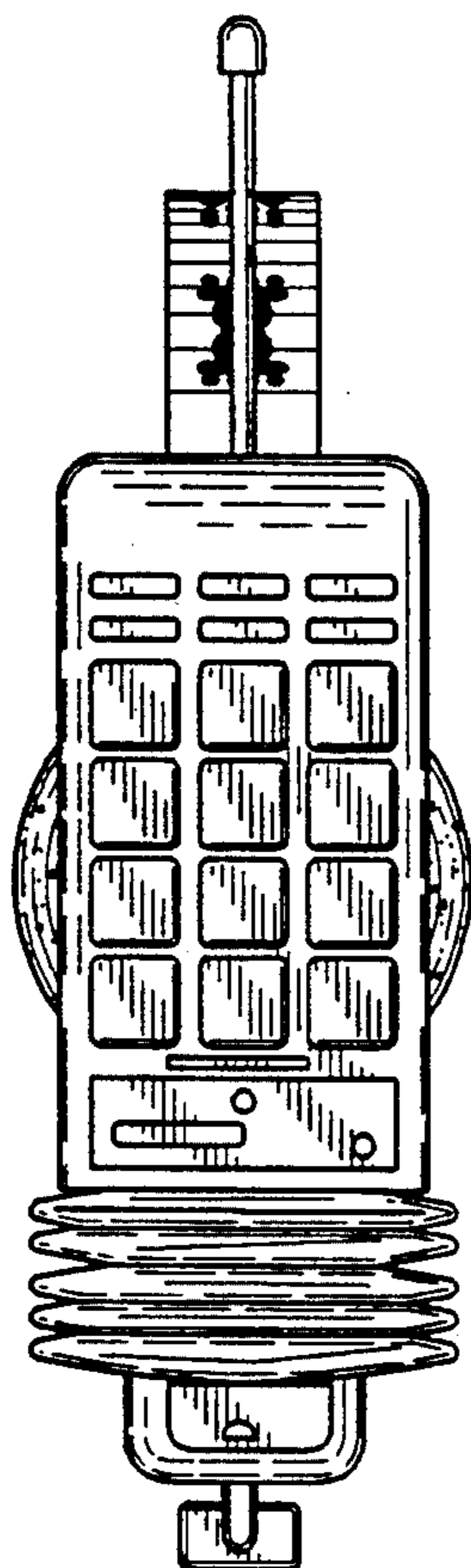

FIG. 2

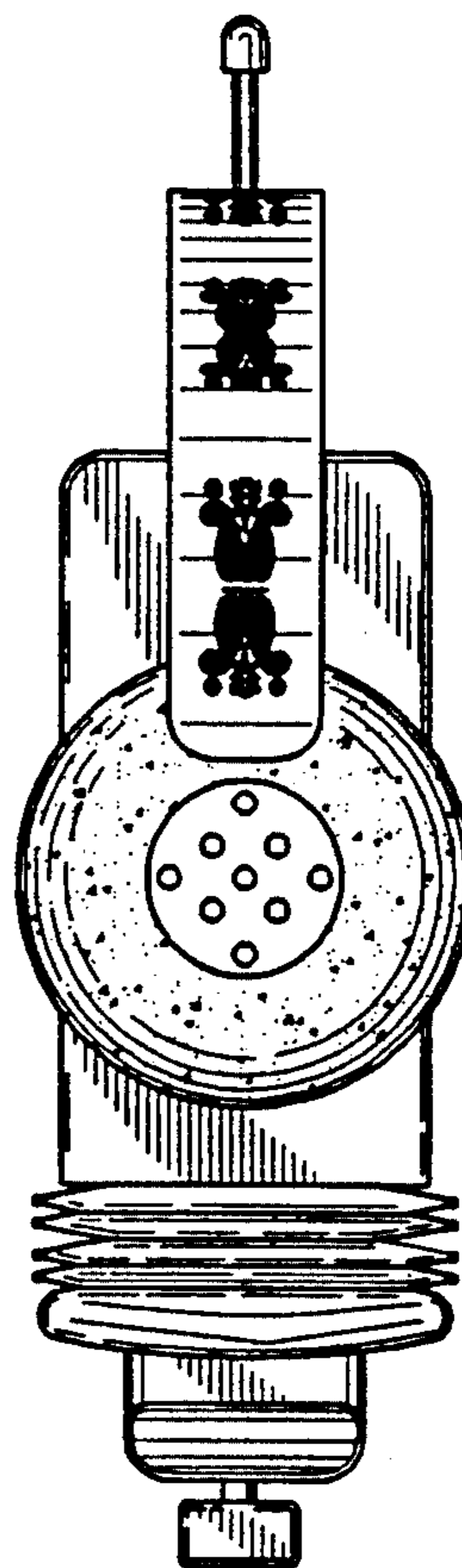

FIG. 3

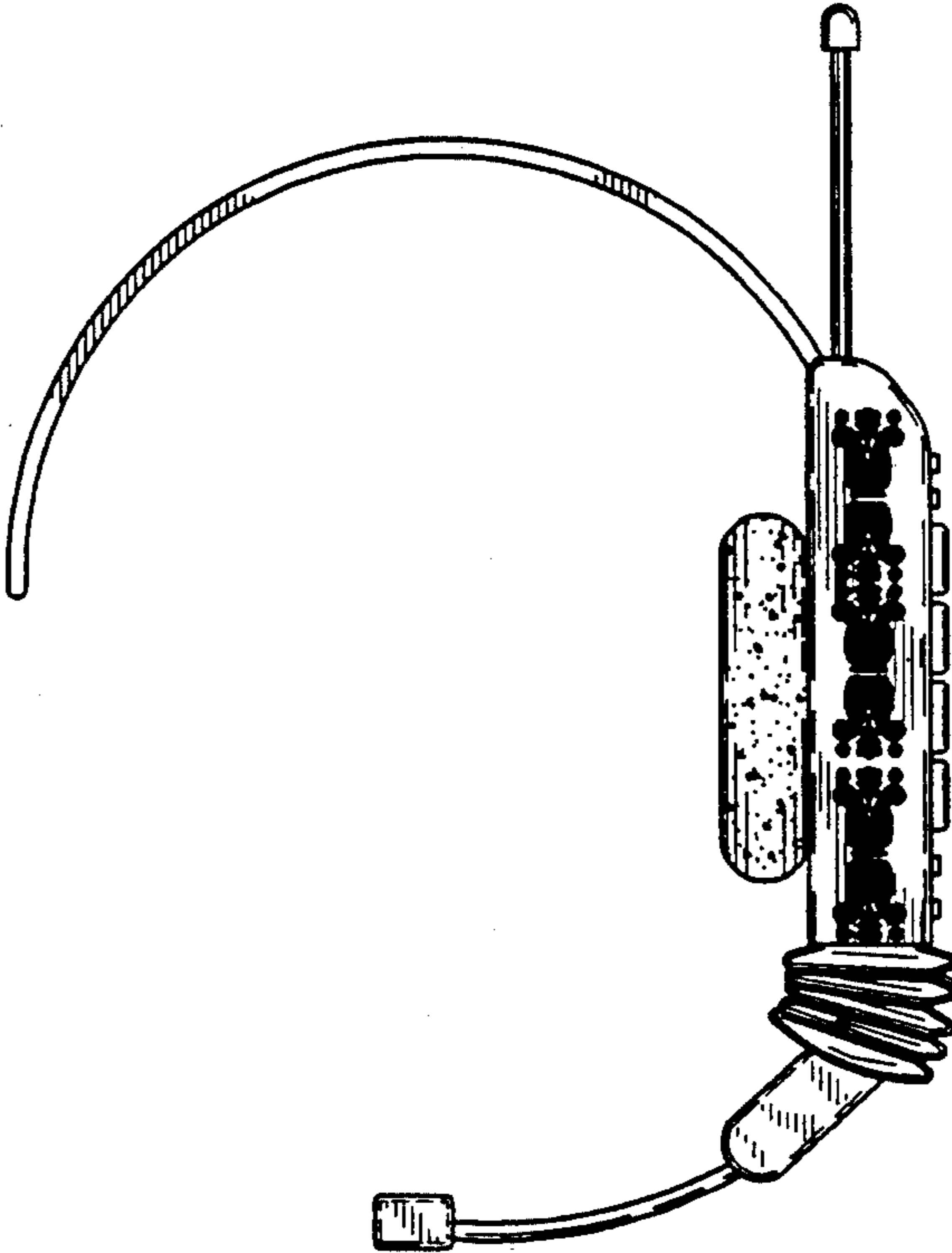

FIG. 4

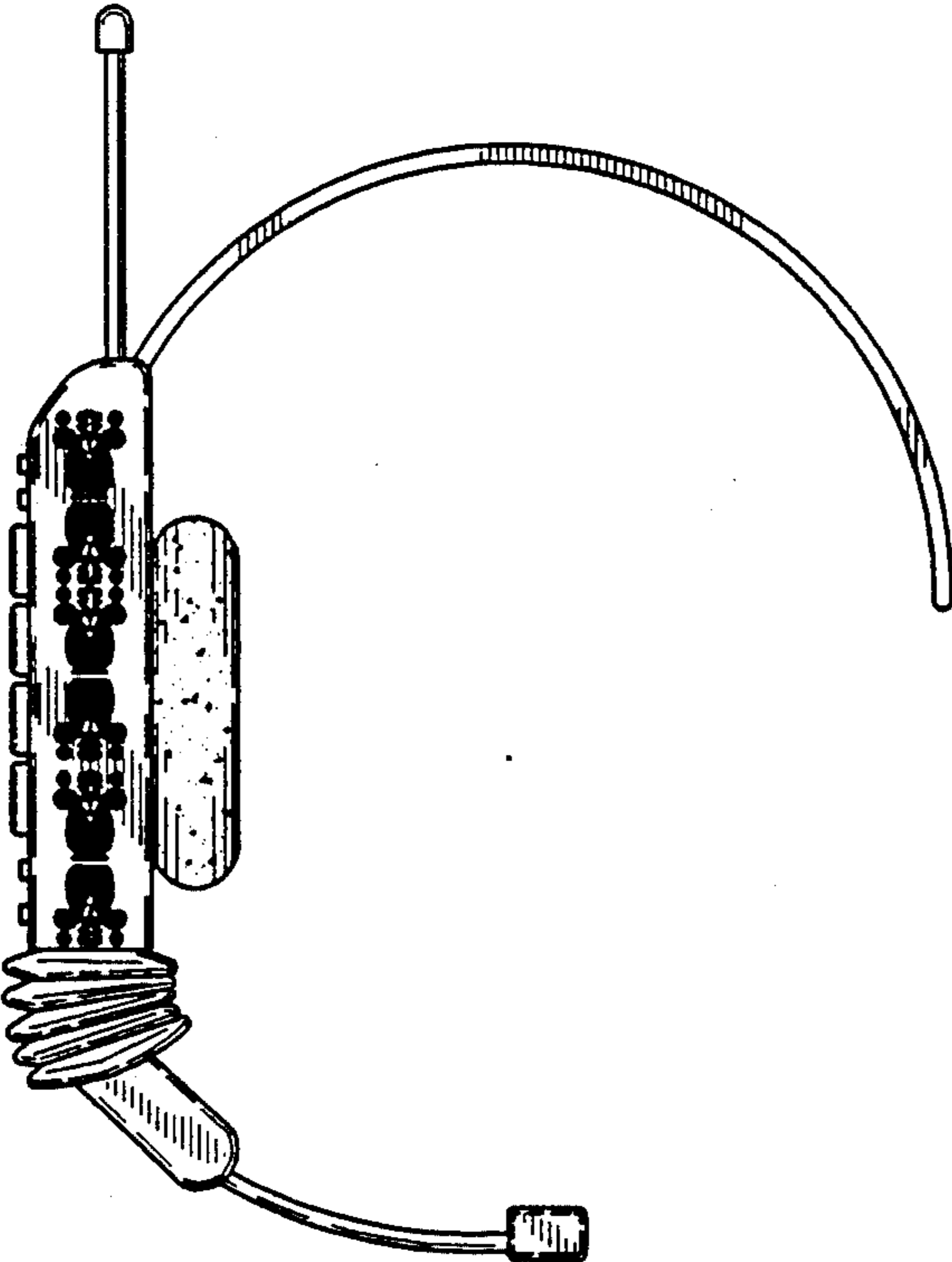

FIG. 5

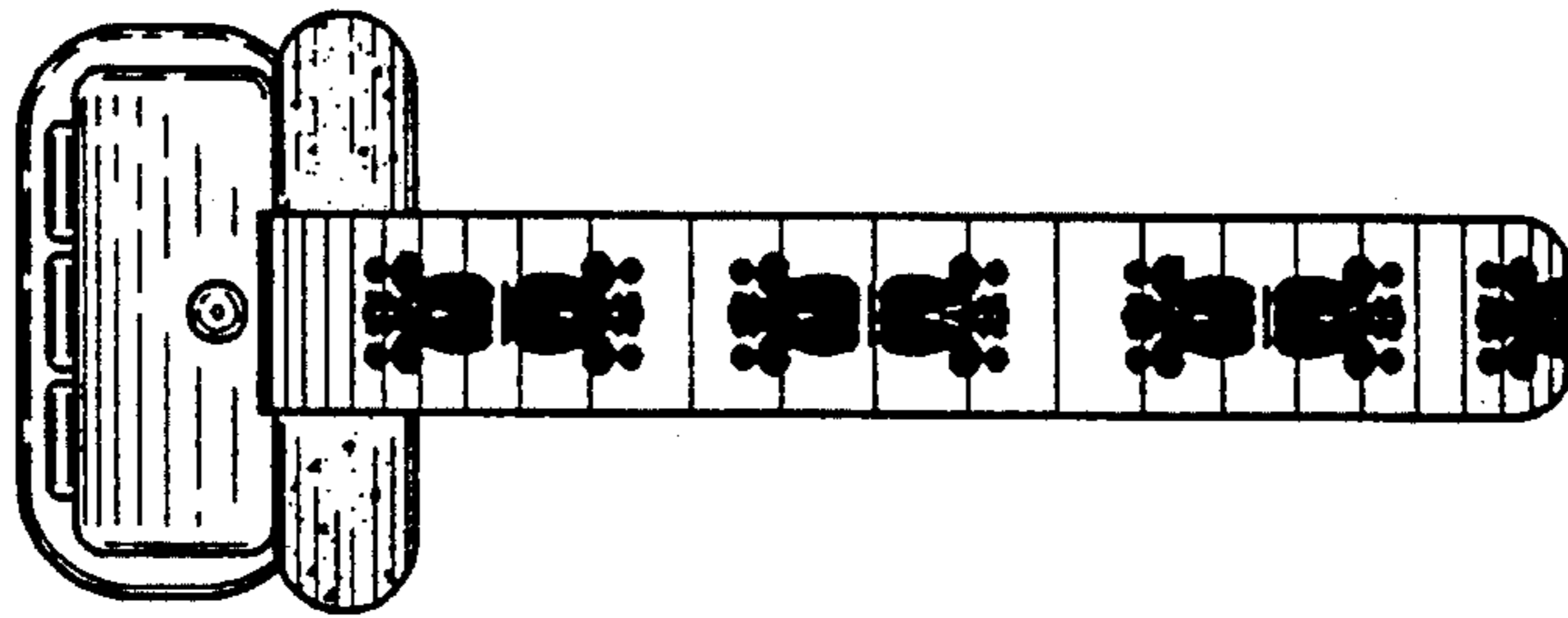

FIG. 6

