



US00D333304S

United States Patent [19]

[11] Patent Number: Des. 333,304

Taniuchi et al.

[45] Date of Patent: ** Feb. 16, 1993

[54] COMBINATION TELEPHONE, FACSIMILE, STILL PICTURE TELEVISION INFORMATION COMMUNICATION APPARATUS FOR HOME OR OFFICE USE

[75] Inventors: Takeshi Taniuchi; Kozo Shima, both of Kamakura, Japan; Gregory S. Breiding, Columbus; Spencer B. Murrell, Delaware, both of Ohio

[73] Assignee: Mitsubishi Denki Kabushiki Kaisha, Tokyo, Japan

[**] Term: 14 Years

[21] Appl. No.: 677,742

[22] Filed: Mar. 29, 1991

[52] U.S. Cl. D14/130; D14/240; D14/140; D14/144; D14/101

[58] Field of Search D14/144, 130; 379/433, 379/428, 436

[56] References Cited

U.S. PATENT DOCUMENTS

D. 296,891	7/1988	Taniuchi et al.	D14/130
D. 296,893	7/1988	Taniuchi et al.	D14/130
D. 308,970	7/1990	Takai et al.	D14/130
D. 309,304	7/1990	Takada et al.	D14/130 X
D. 313,231	12/1990	Taniuchi	D14/130
D. 321,870	11/1991	Beecher et al.	D14/130
D. 324,036	2/1992	Wakasa	D14/144 X
4,577,068	3/1986	Kelly et al.	D14/130 X

Primary Examiner—Horace B. Fay, Jr.

Attorney, Agent, or Firm—Rothwell, Figg, Ernst & Kurz

[57] CLAIM

The ornamental design for a combination telephone, facsimile and still picture television information communication apparatus for home or office use, as shown and described.

DESCRIPTION

FIG. 1 is a front elevational view of a combination telephone, facsimile and still picture television information communication apparatus for home or office use showing our new design;

FIG. 2 is a rear elevational view thereof;

FIG. 3 and 4 are respectively left and right side elevational views thereof;

FIG. 5 and 6 are respectively top and bottom plan views thereof;

FIG. 7 is a left side and front perspective view of the combination telephone communication apparatus et al. with the handset right side, and bottom perspective view spaced apart thereof;

FIG. 8 is a left side and front perspective view of the combination apparatus supported by its stand and having its handset cradled upon the main apparatus body;

FIG. 9 is a cross sectional view of FIG. 1 viewed from the right; and

FIG. 10 is a cross sectional view showing direction of facsimile paper flow.

The broken line showing of encircled numbers and symbols, and girdled words in FIG. 7 is for illustrative purposes only and forms no part of the claimed design.

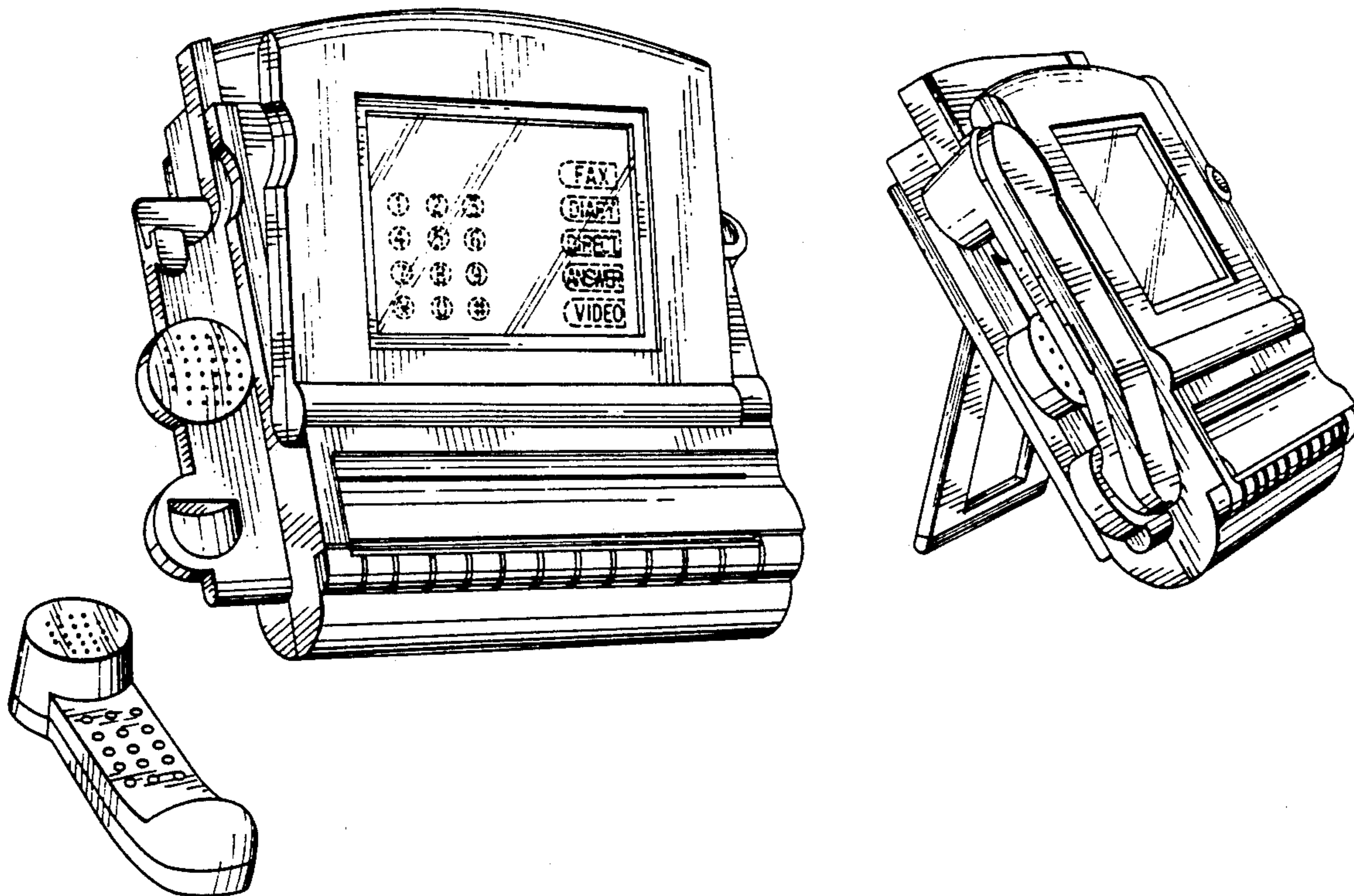

FIG. 1

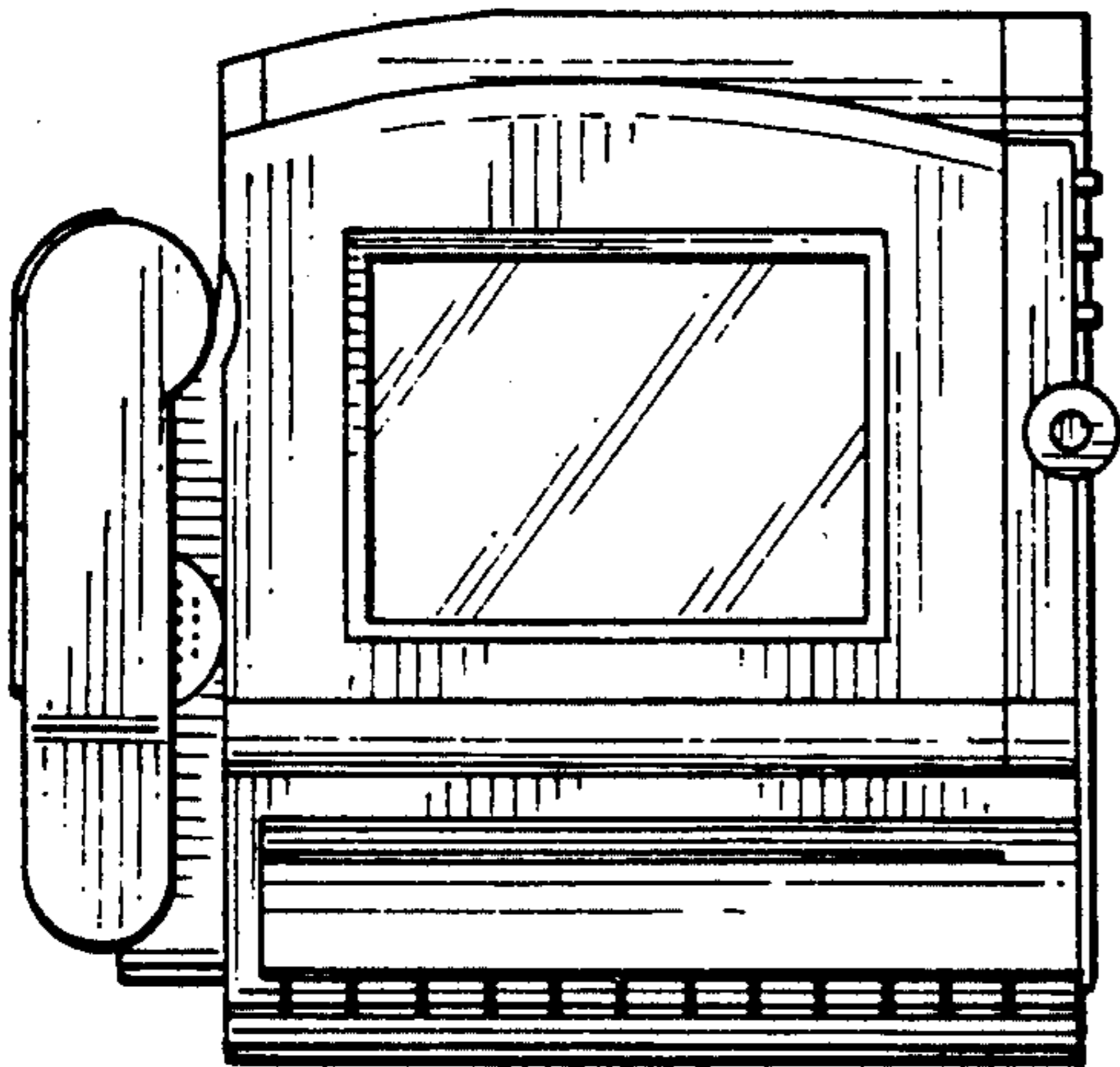

FIG. 2

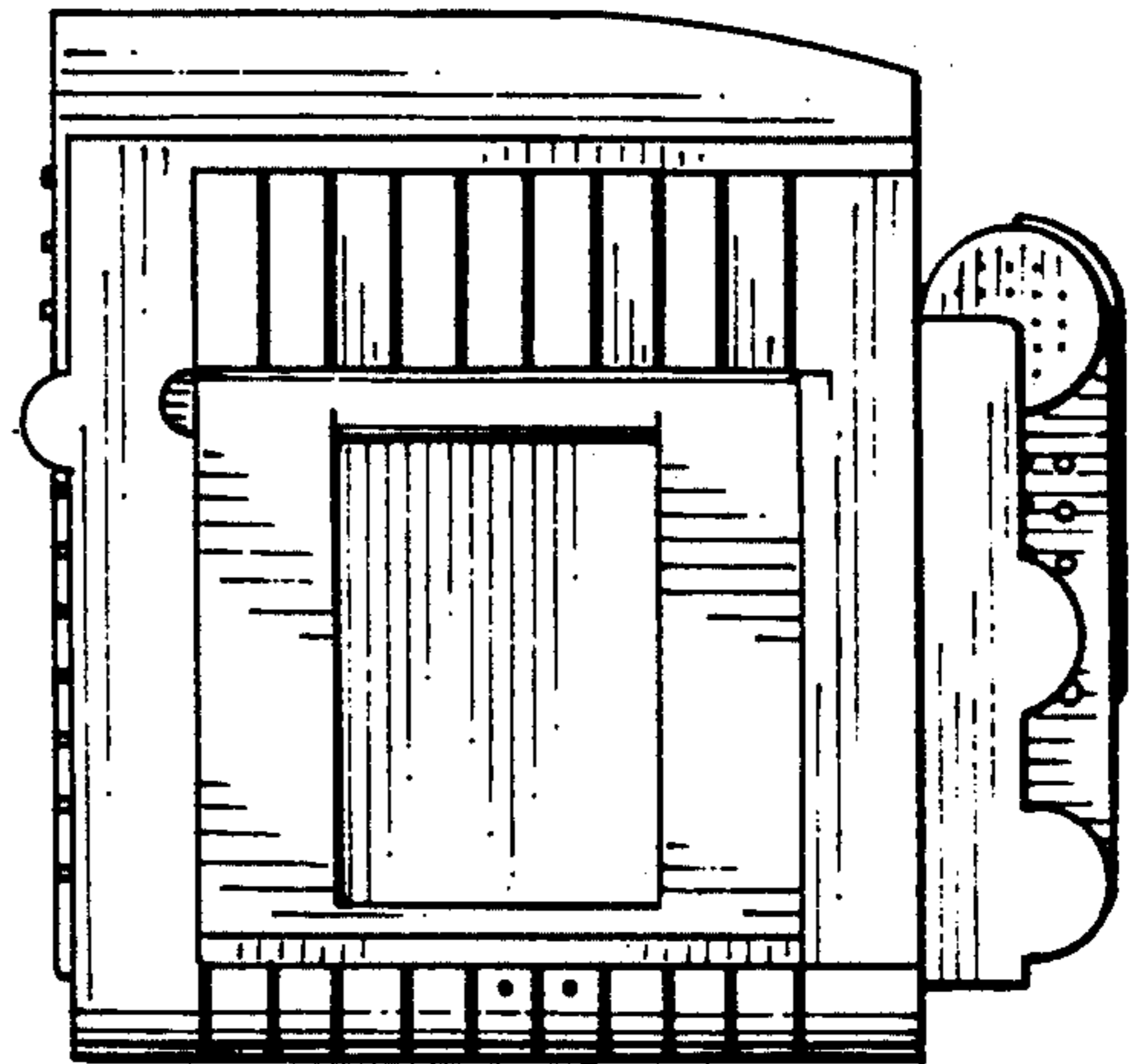

FIG. 3

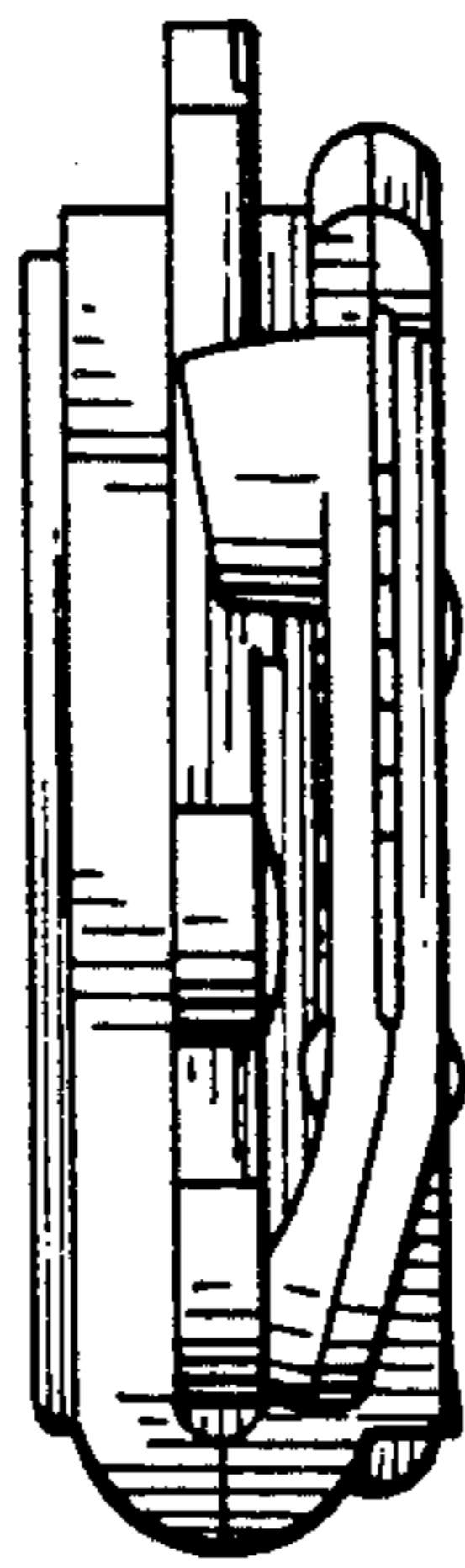

FIG. 4

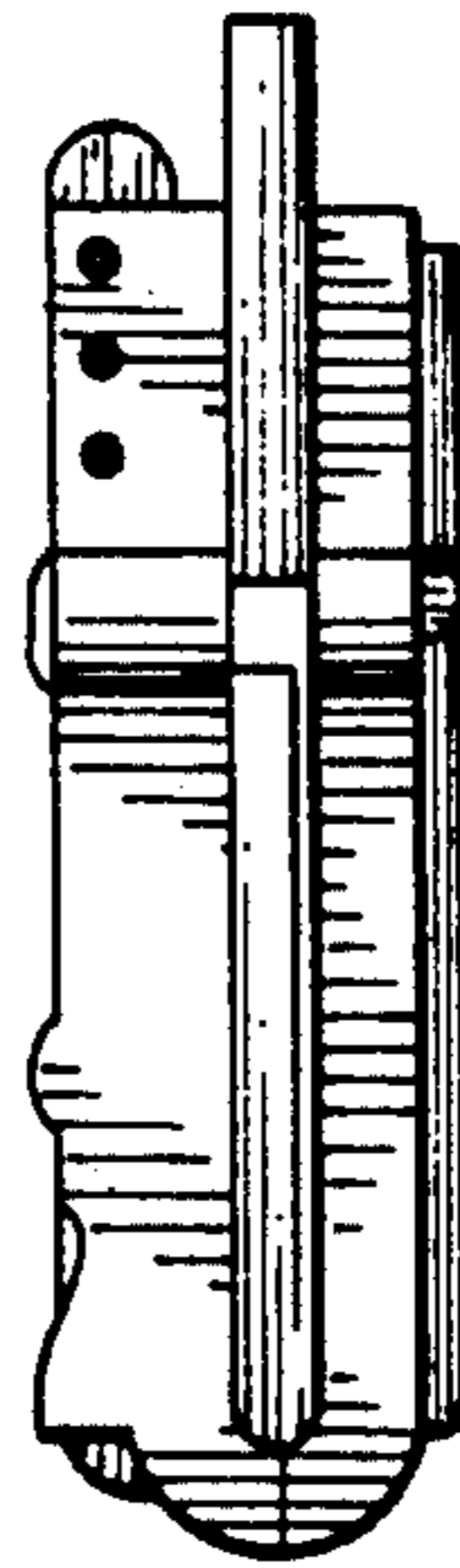

FIG. 5

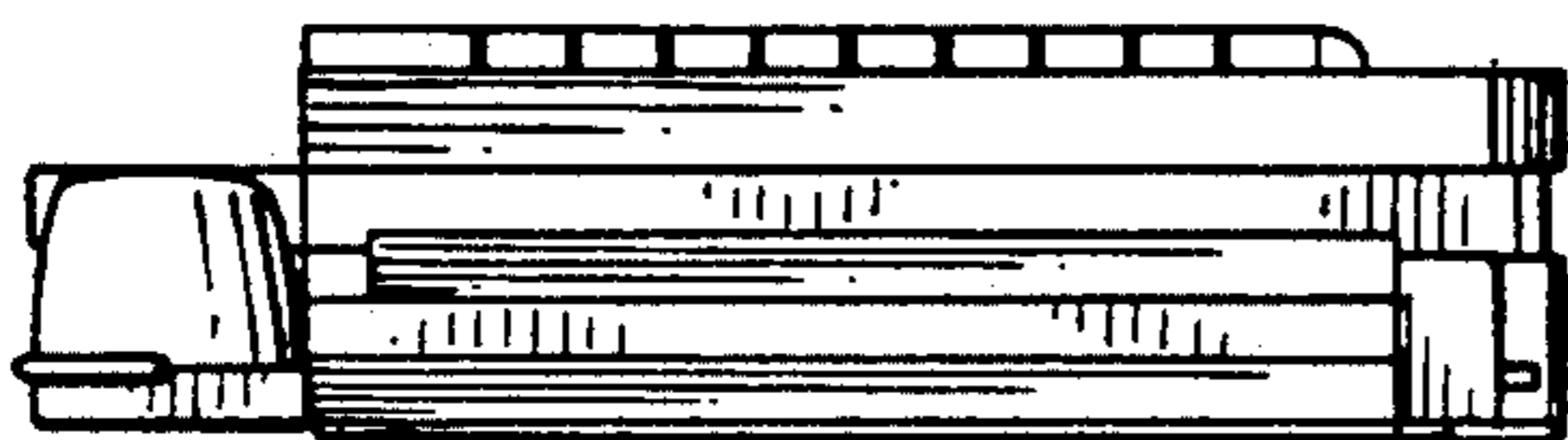

FIG. 6



FIG. 7

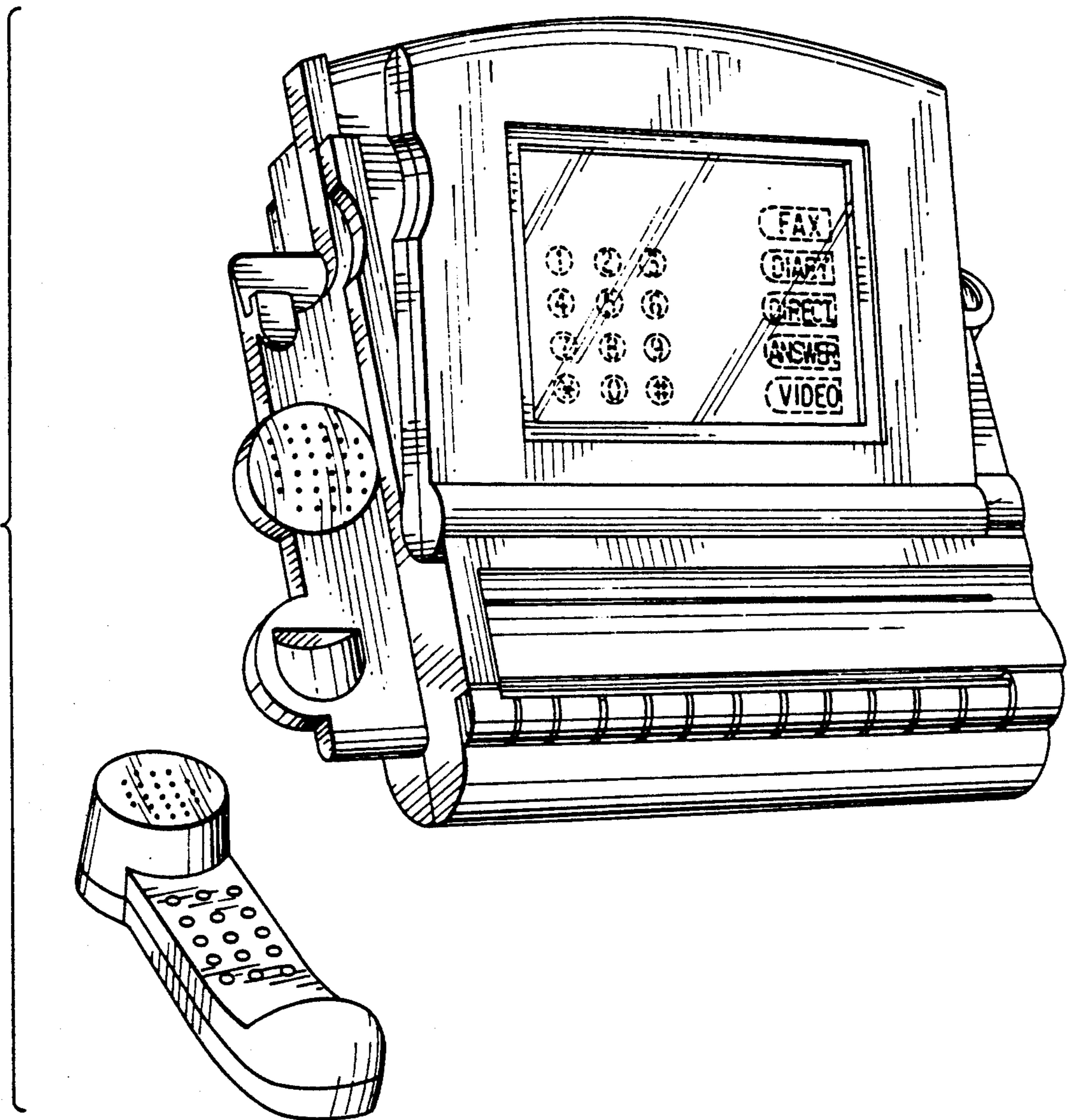

FIG. 8

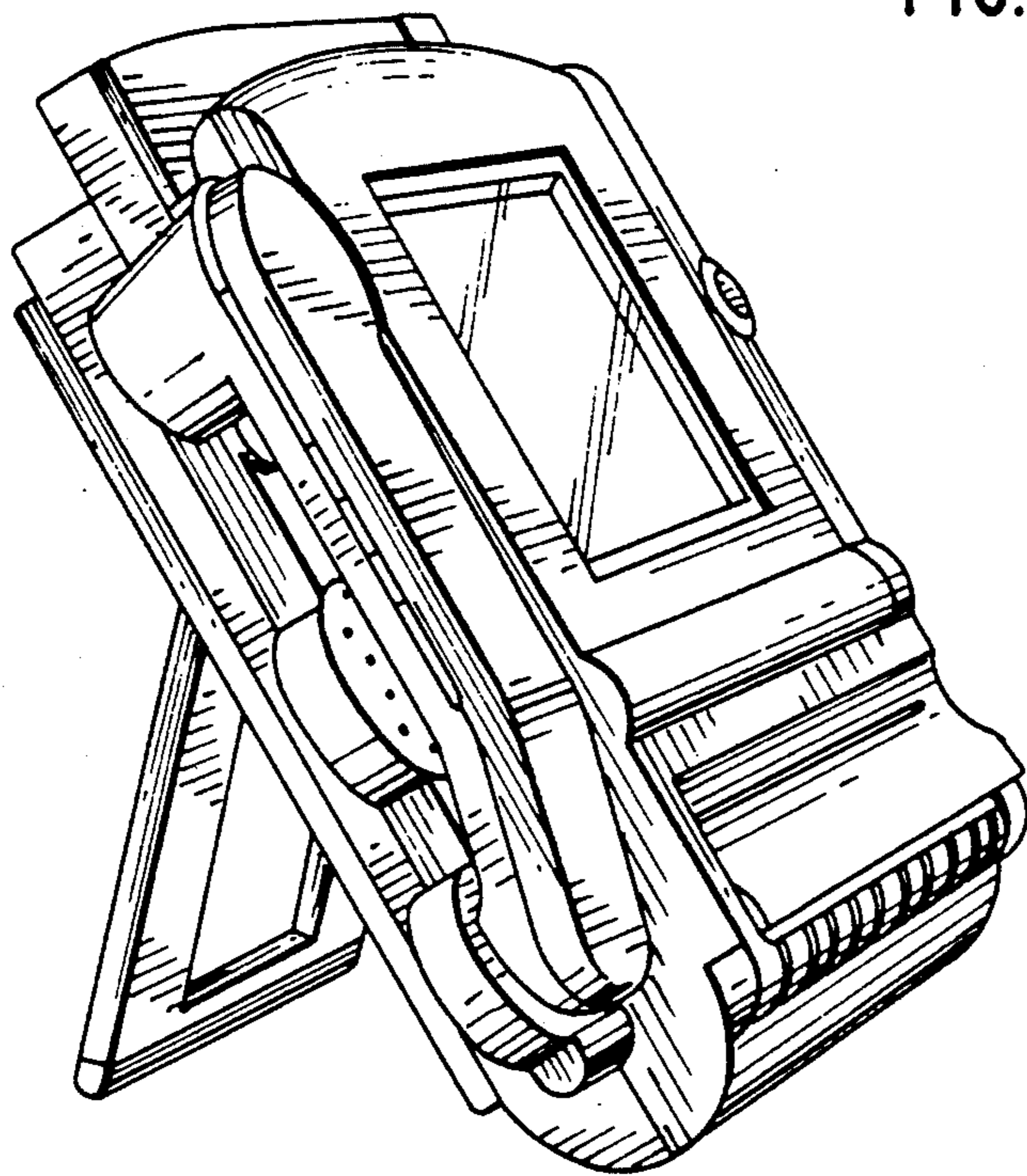

FIG. 9

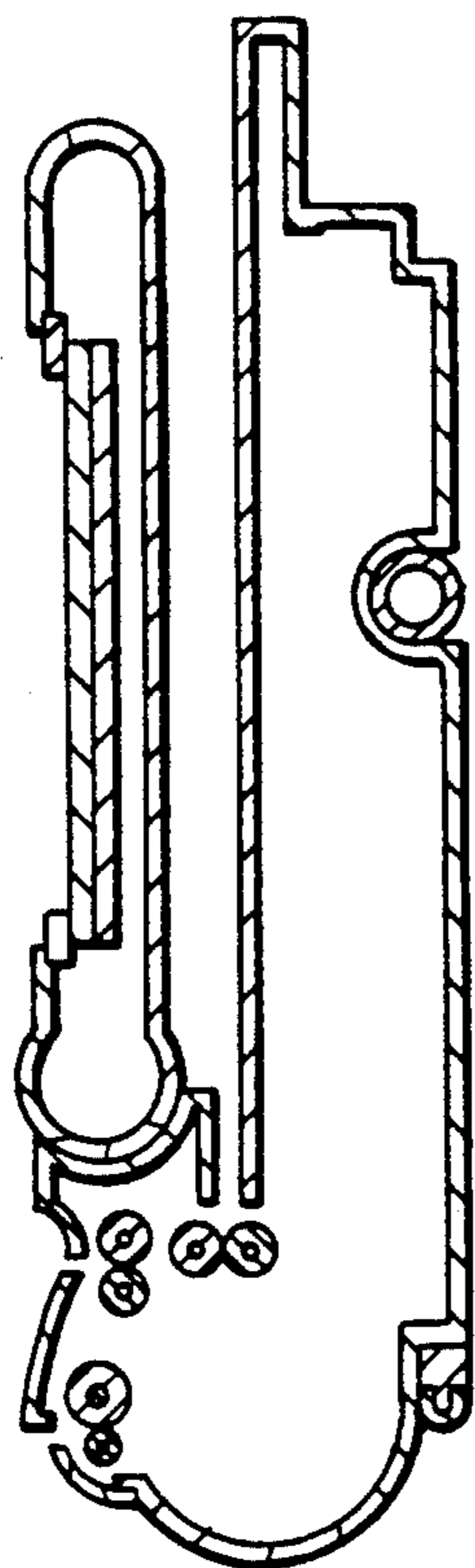

FIG. 10

