



US00D333262S

United States Patent [19] Zogg

[11] Patent Number: Des. 333,262
[45] Date of Patent: ** Feb. 16, 1993

- [54] DISPENSING CARTON
- [75] Inventor: Edward Zogg, Buffalo, N.Y.
- [73] Assignee: Bristol-Myers Squibb Company, New York, N.Y.
- [**] Term: 14 Years
- [21] Appl. No.: 698,063
- [22] Filed: May 10, 1991
- [52] U.S. Cl. D9/339; D9/416; D9/433
- [58] Field of Search D9/339, 416, 430-433; D6/515, 517, 520, 522; 229/104, 120.02, 120.08; 221/32, 305

[56] **References Cited**
U.S. PATENT DOCUMENTS

D. 120,649	5/1940	Novak	D6/517
D. 123,125	10/1940	Holstein et al.	D9/433 X
1,682,463	8/1928	Anderson	206/45.14
1,875,781	9/1932	Turner	206/44.12
1,915,341	6/1933	Walker et al. .	
1,966,676	7/1917	Marsh	221/311
1,987,771	1/1935	Bueschel	206/121
2,067,749	1/1937	Zimmerman et al. .	
2,188,732	1/1940	Vogt	229/104
2,595,202	4/1952	Pardee .	
2,780,385	2/1957	Tupper	D9/431 X
4,294,397	10/1981	Kohler .	
4,342,417	8/1982	Forbes, Jr. .	

4,541,526 9/1985 Berg et al. .

Primary Examiner—Bernard Ansher
Assistant Examiner—Mitchell I. Siegel
Attorney, Agent, or Firm—Jones, Tullar & Cooper

[57] **CLAIM**

The ornamental design for dispensing carton, as shown and described.

DESCRIPTION

FIG. 1 is a front perspective view of a dispensing carton showing my new design;
 FIG. 2 is a right side elevational view thereof;
 FIG. 3 is a top plan view thereof;
 FIG. 4 is a bottom rear perspective view thereof;
 FIG. 5 is a left side elevational view thereof;
 FIG. 6 is a bottom plan view thereof;
 FIG. 7 is a fragmentary front perspective view of the lower portion of the dispensing carton with tear flap removed, and shown for clarity of illustration;
 FIG. 8 is a fragmentary bottom front perspective view of the dispensing carton thereof;
 FIG. 9 is a top plan view of the dispensing carton with cover flaps open;
 FIG. 10 is a bottom plan view thereof;
 FIG. 11 is a bottom rear perspective as FIG. 4, with support easel in an alternate position;
 FIG. 12 is a left side elevational view thereof; and,
 FIG. 13 is a top plan view of a blank for a dispensing carton shown for clarity of illustration.

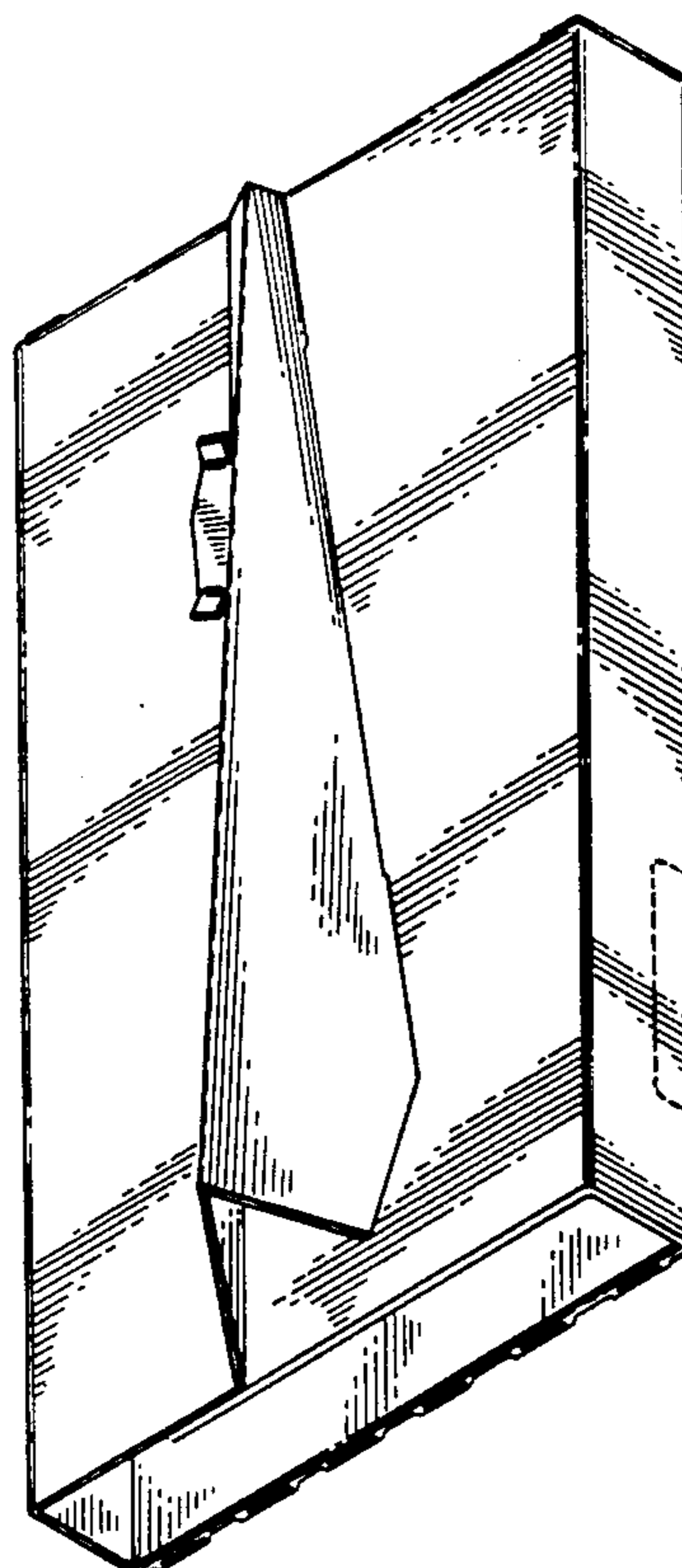
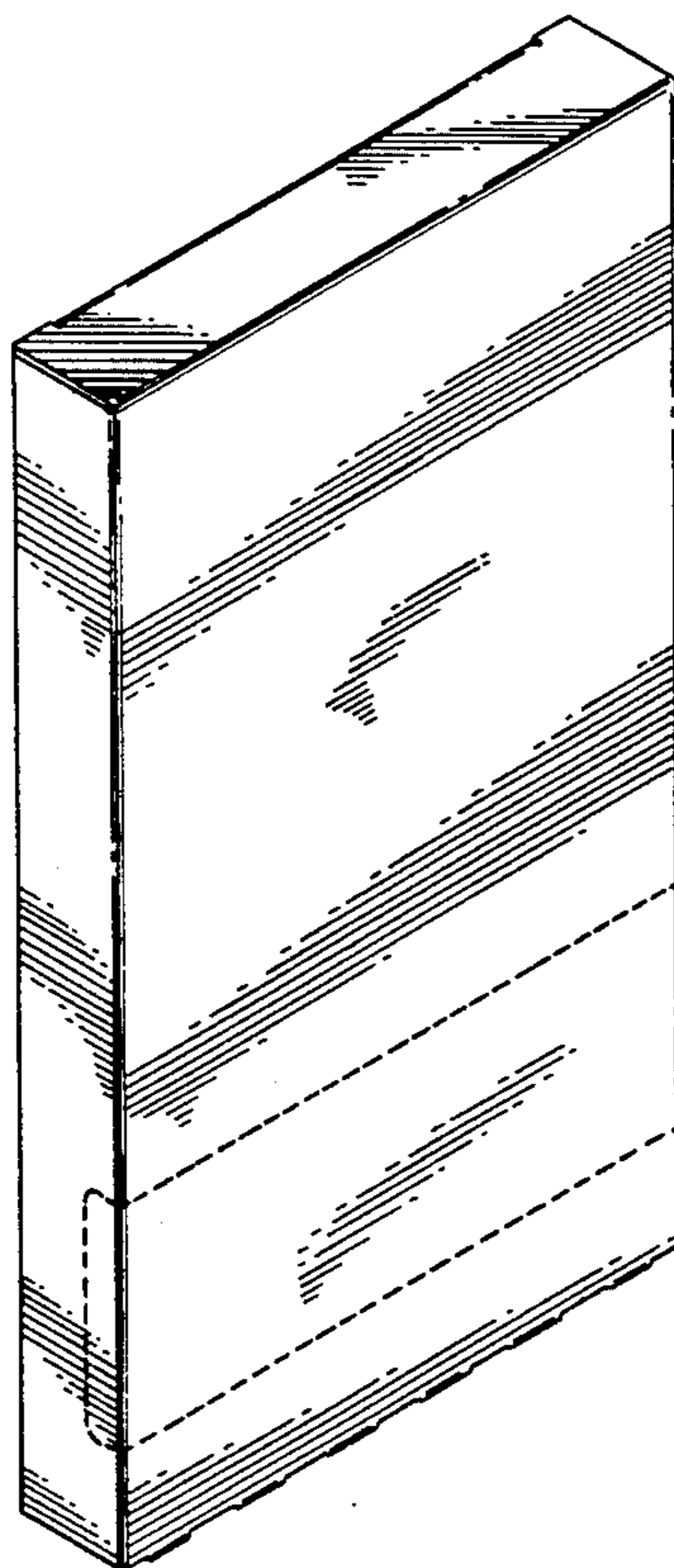

FIG. 1

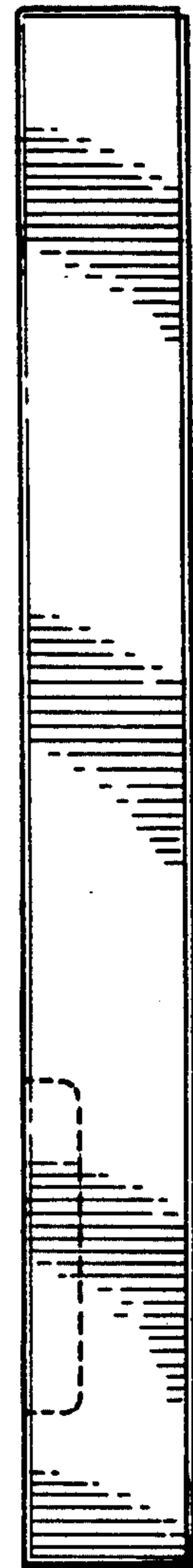
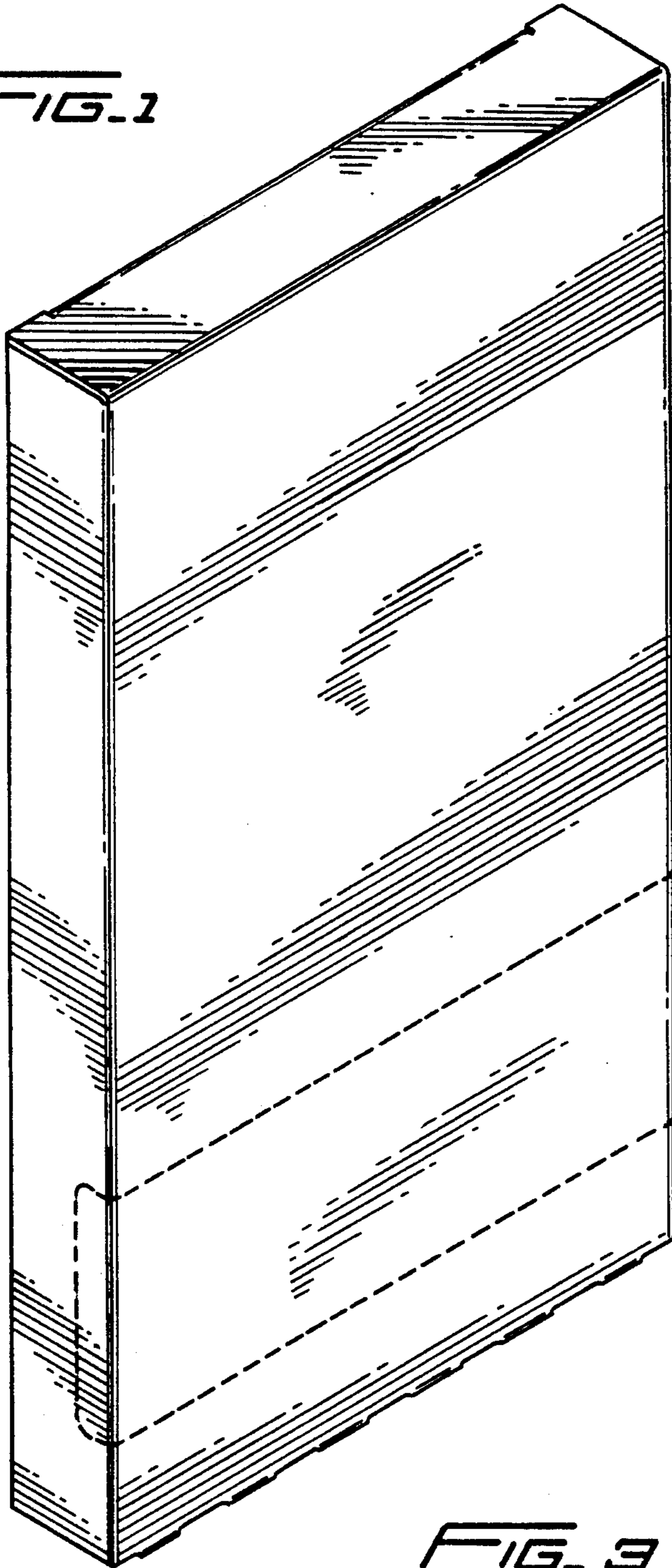

FIG. 2

FIG. 3



FIG. 4

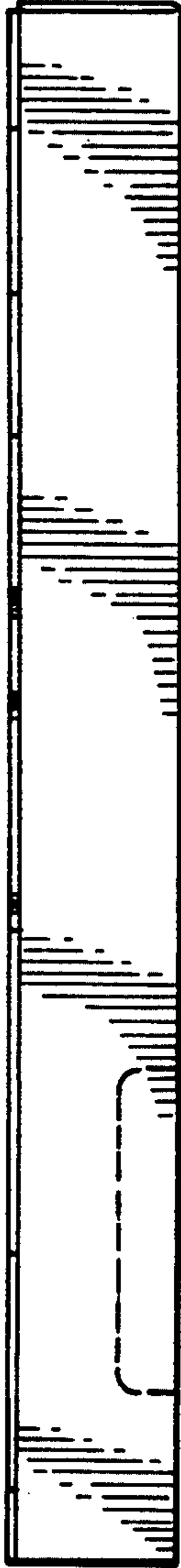
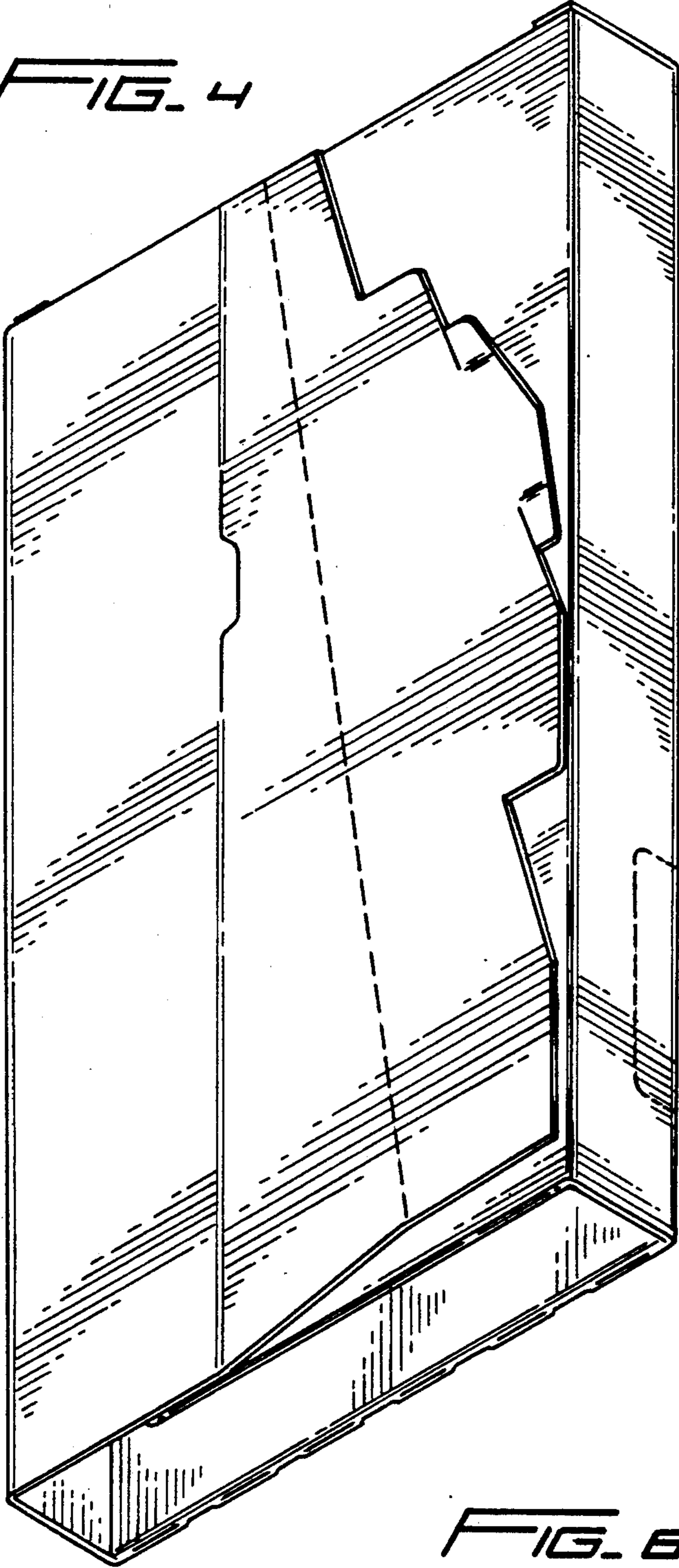

FIG. 5

FIG. 6

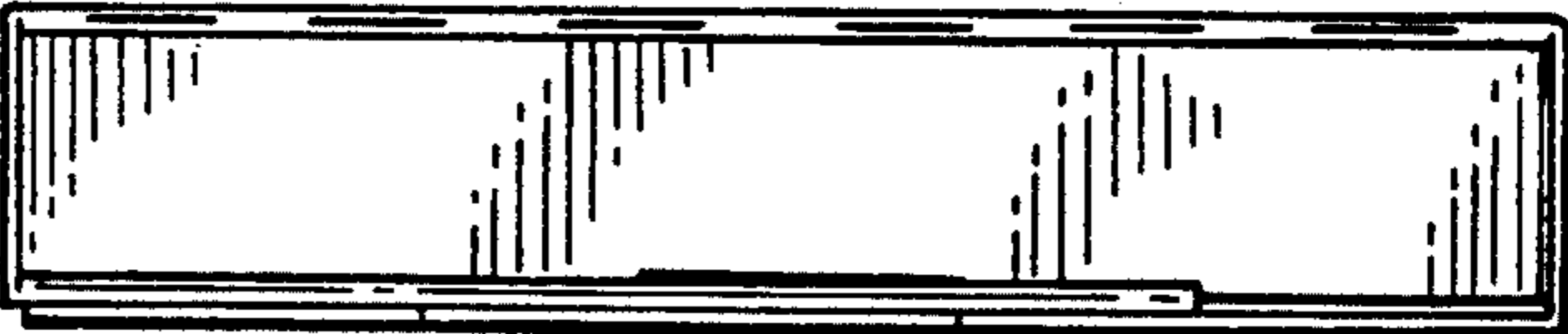

FIG. 7

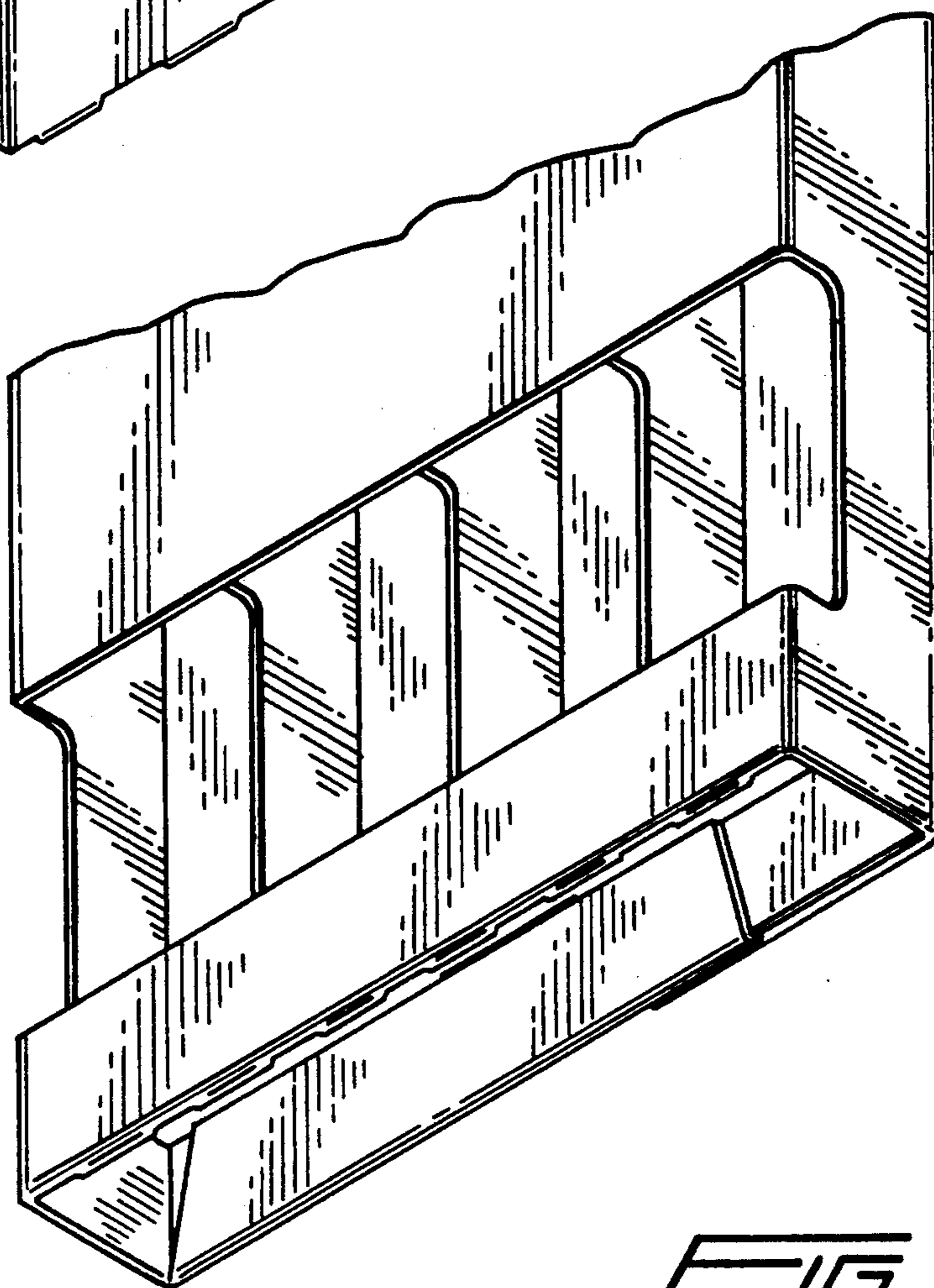
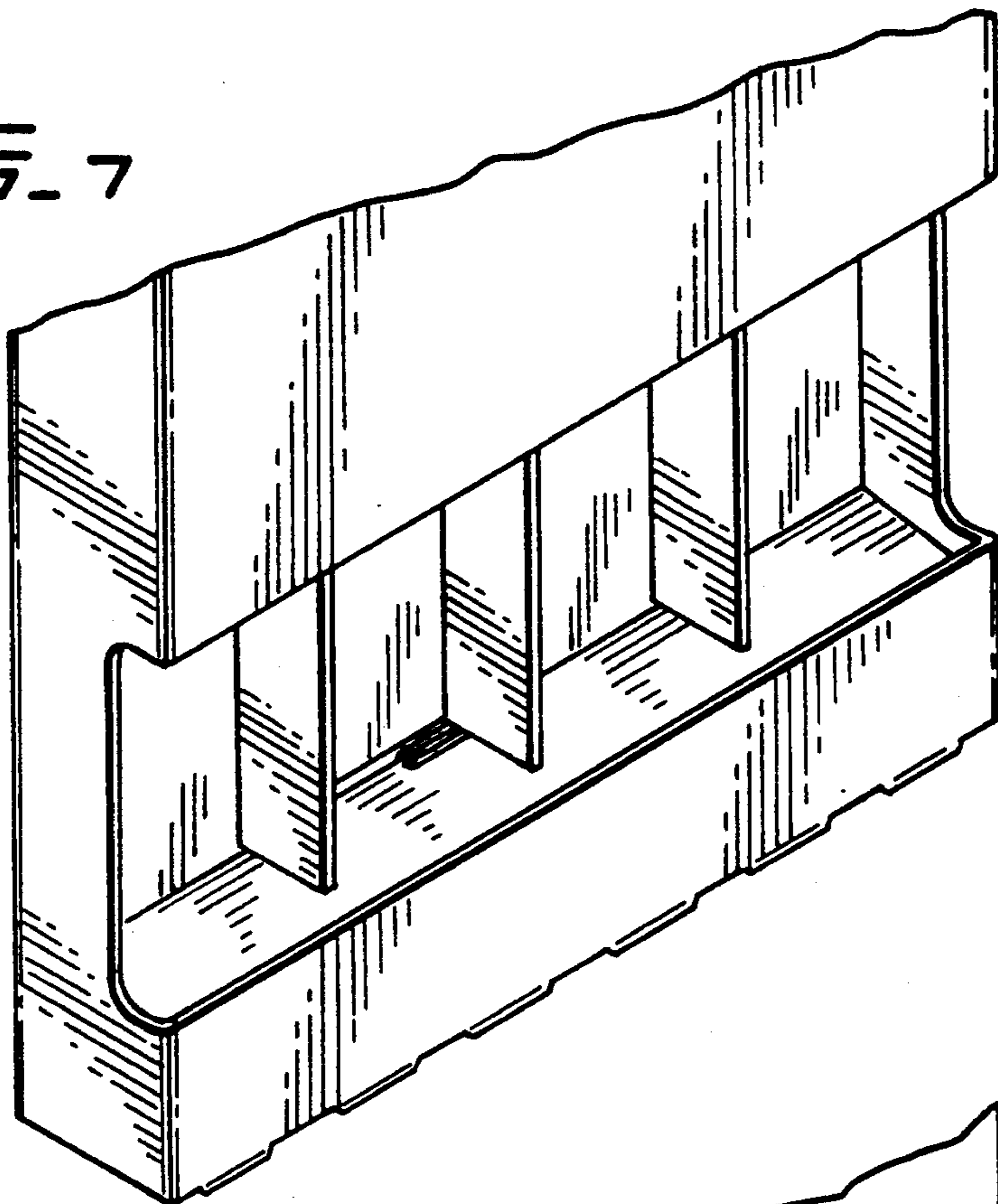

FIG. 8

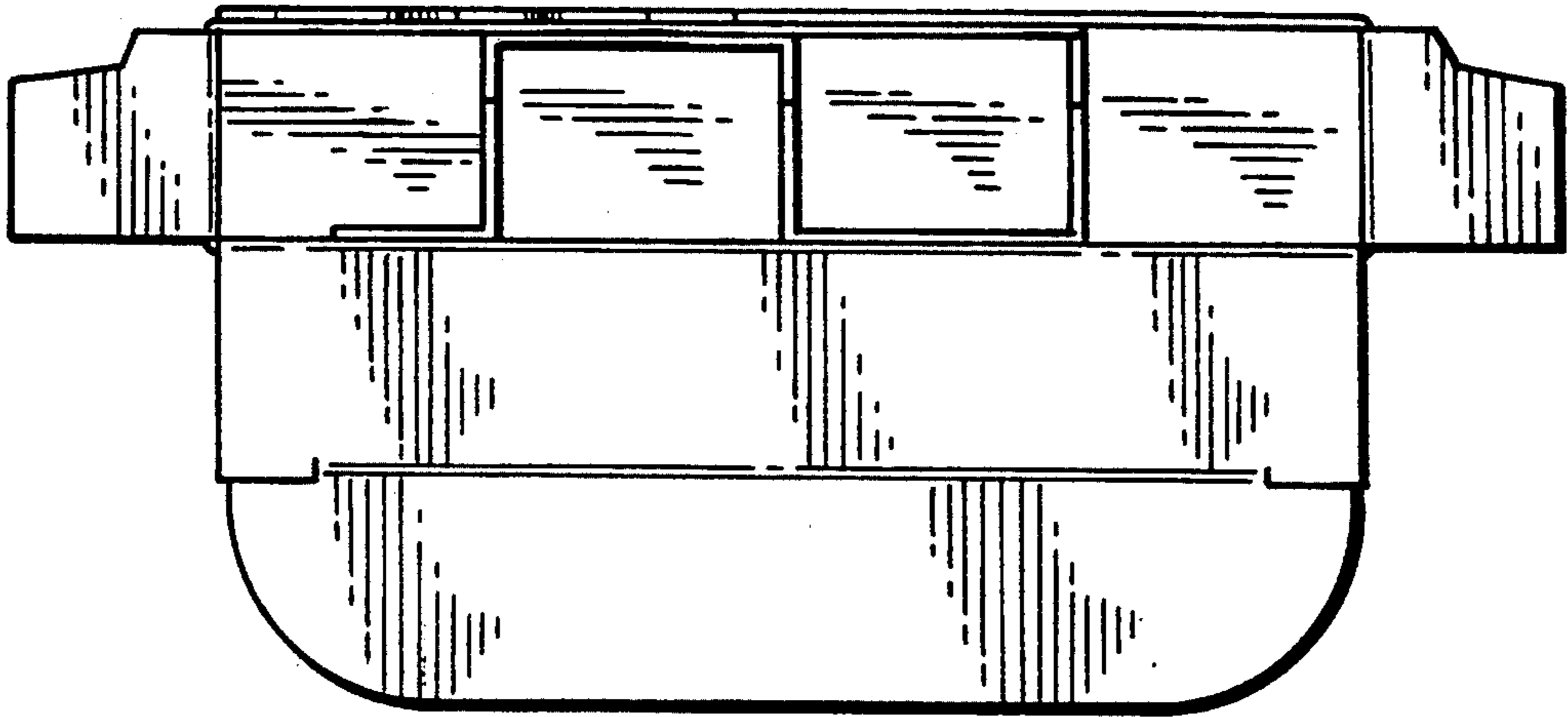

FIG. 9

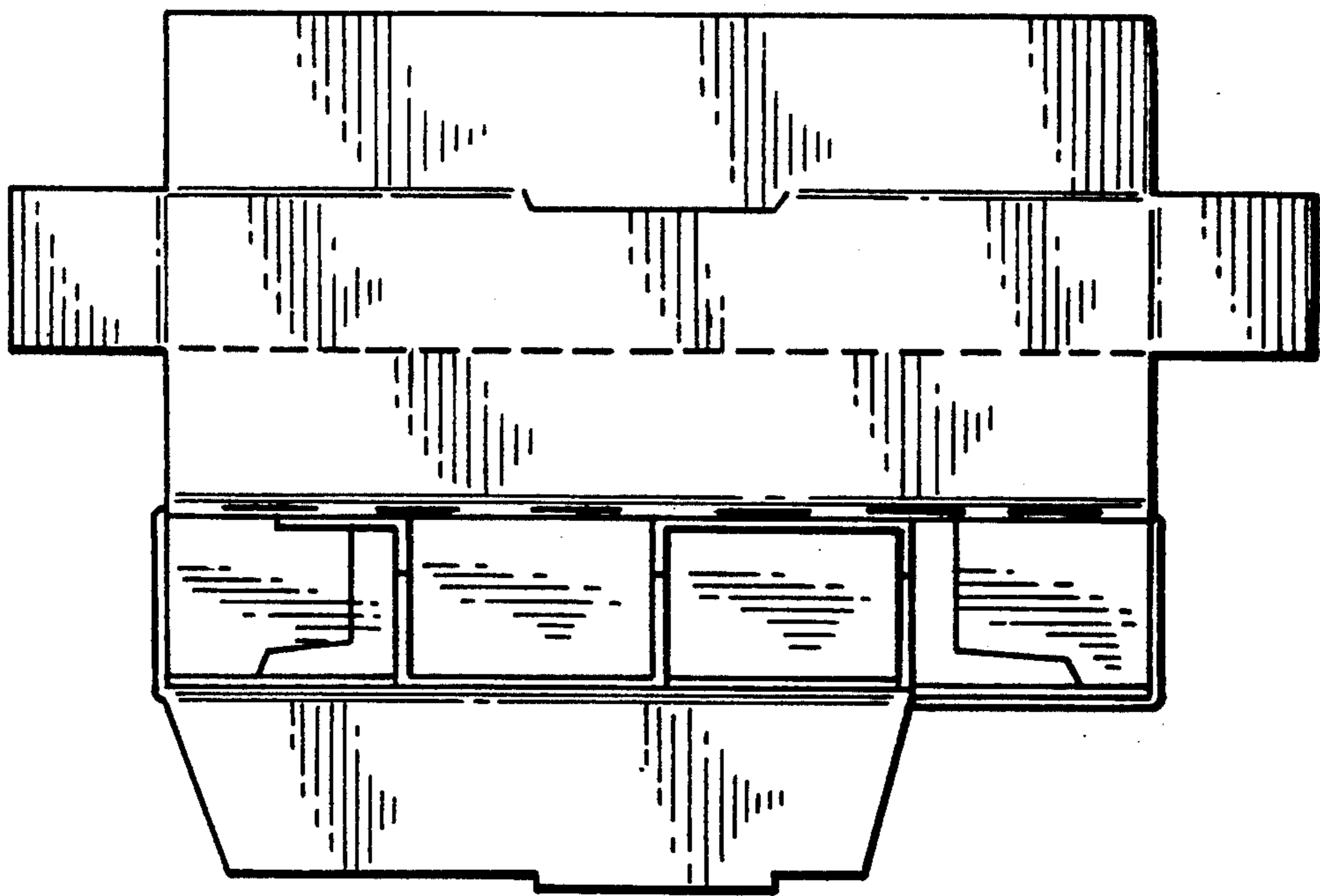

FIG. 10

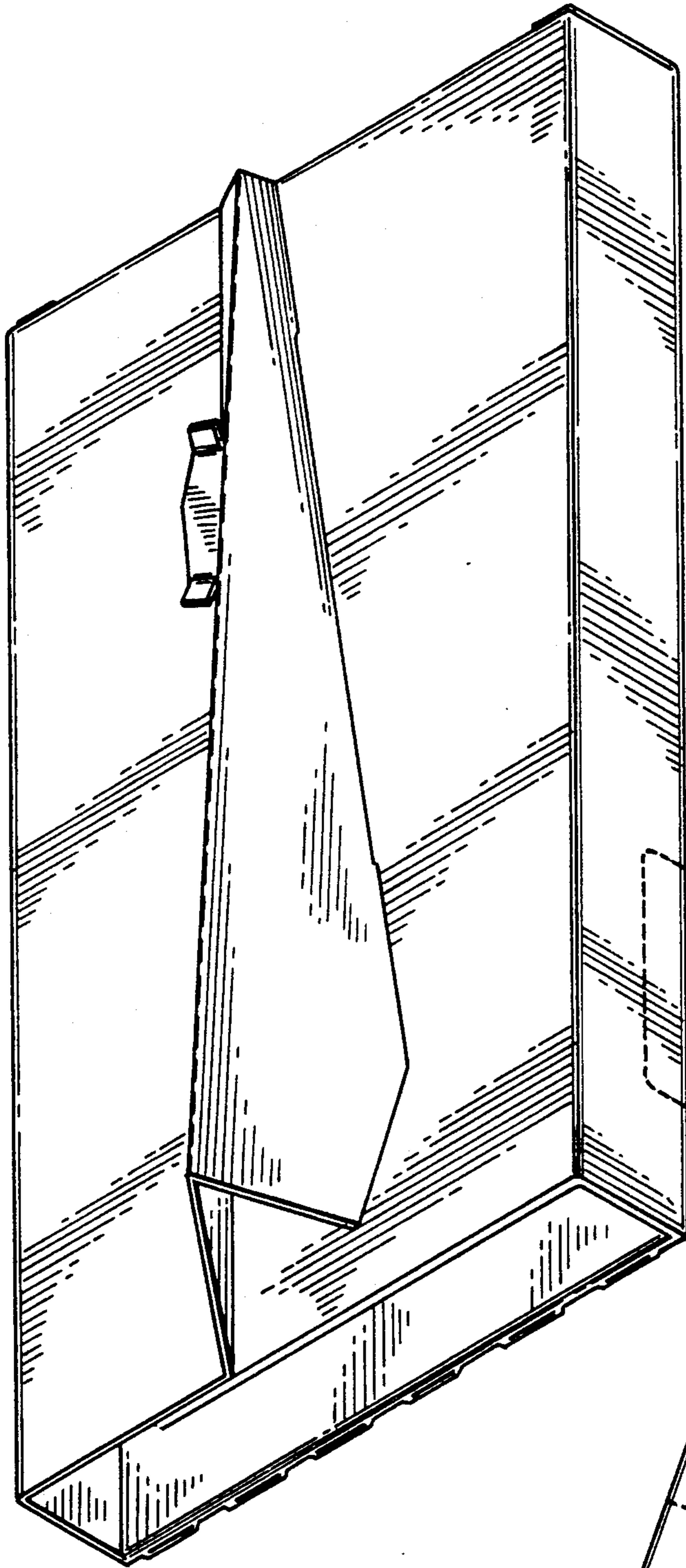

FIG. 11

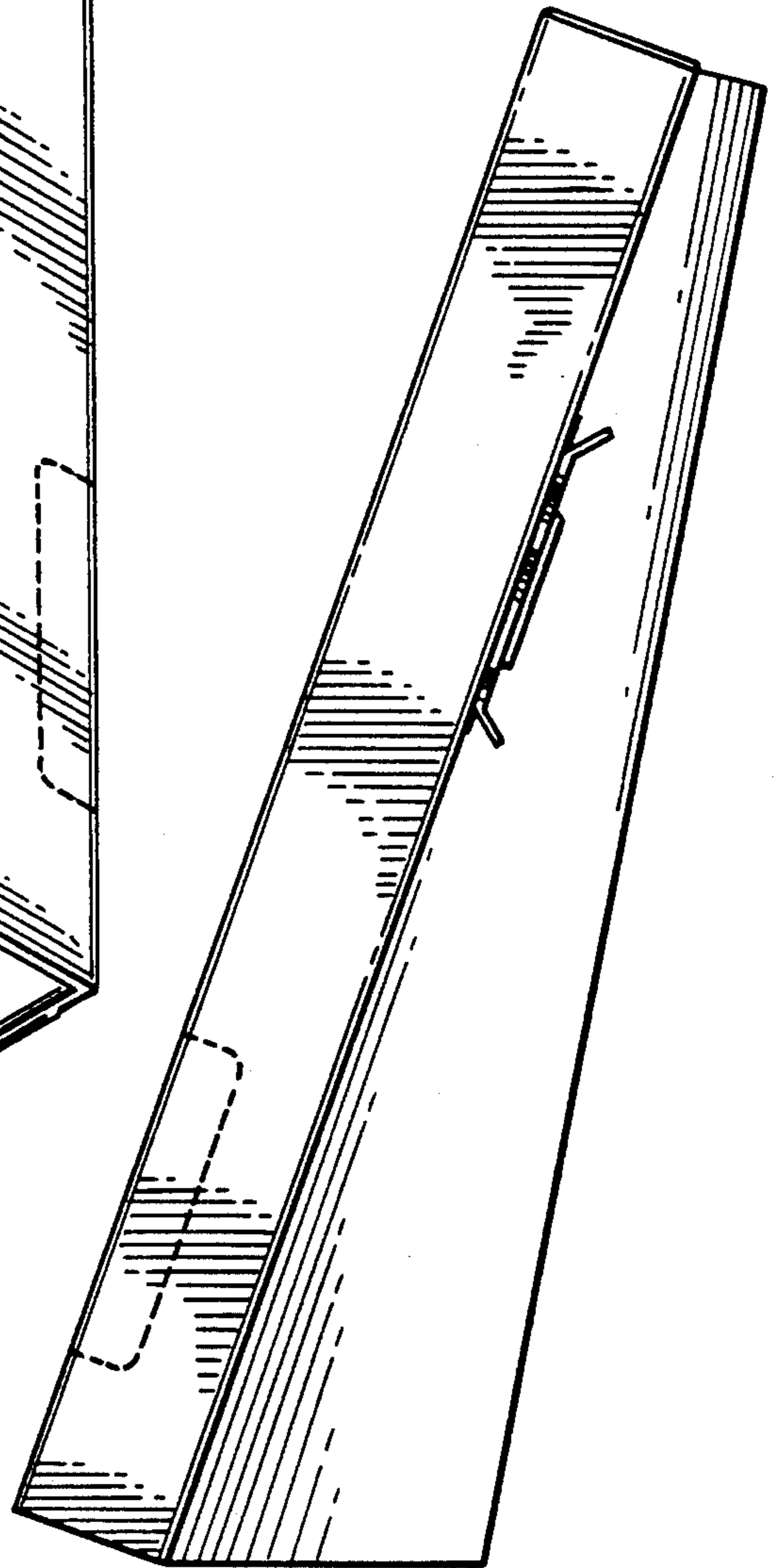

FIG. 12

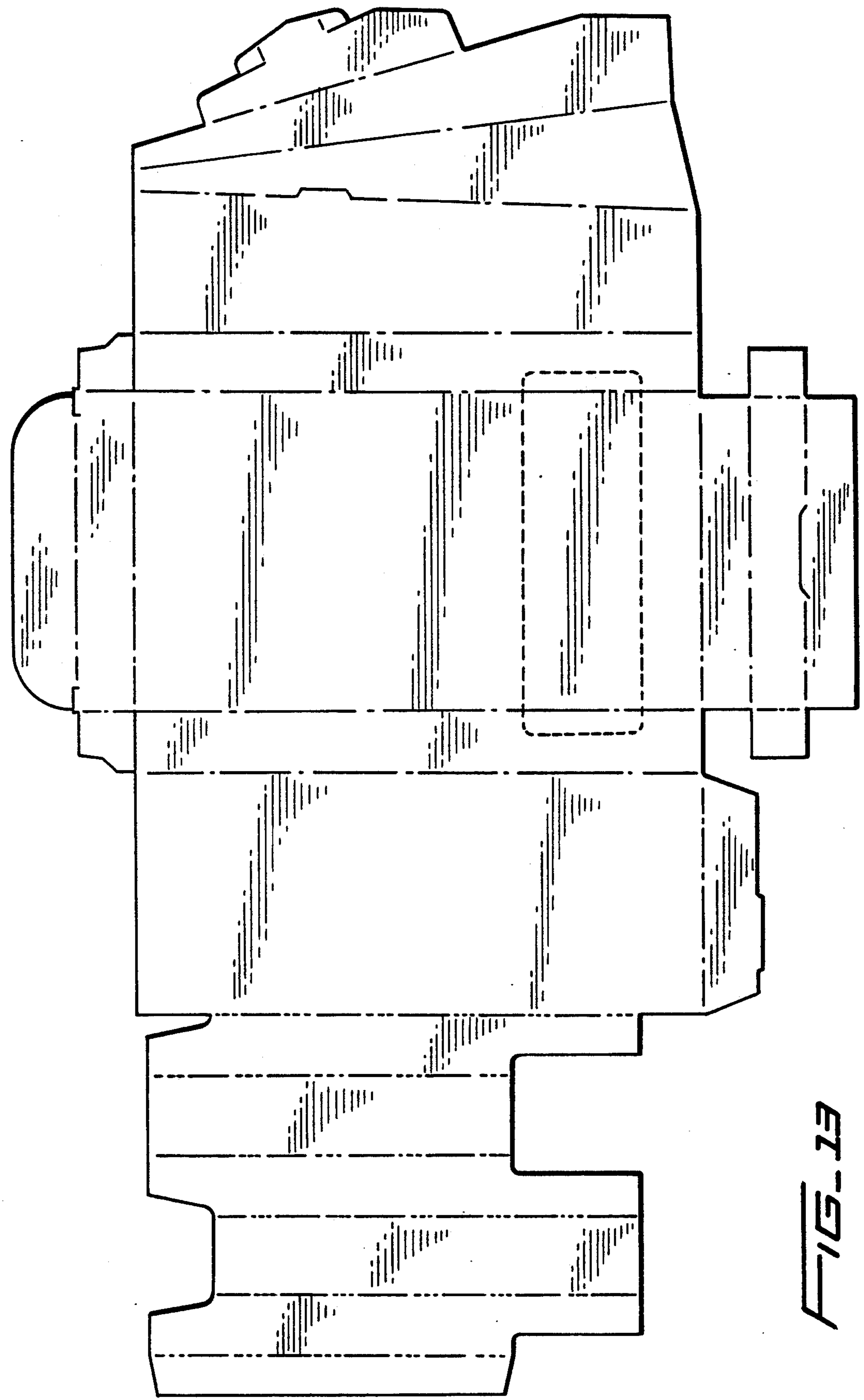

FIG. 13