



US00D333259S

# United States Patent [19] McKeone

[11] Patent Number: Des. 333,259

[45] Date of Patent: \*\* Feb. 16, 1993

[54] SHELF MOUNT

[75] Inventor: William C. McKeone, Sheboygan, Wis.

[73] Assignee: Kohler Co., Kohler, Wis.

[\*\*] Term: 14 Years

[21] Appl. No.: 824,489

[22] Filed: Jan. 22, 1992

[52] U.S. Cl. .... D8/381

[58] Field of Search ..... D8/380-381;  
248/235, 250; 108/42; 211/89-90, 134

[56] References Cited

U.S. PATENT DOCUMENTS

|            |         |               |       |          |
|------------|---------|---------------|-------|----------|
| D. 257,420 | 10/1980 | Follows       | ..... | D8/381 X |
| D. 268,093 | 3/1983  | Wenczl et al. | ..... | D8/381   |
| D. 287,569 | 1/1987  | Shepard       | ..... | D8/381   |
| 3,185,426  | 5/1965  | Bjerks        | ..... | 248/250  |

OTHER PUBLICATIONS

Undated, admitted prior art, Villeroy & Boch ad entitled "Kitchen Sinks", showing a shelf mount.

Primary Examiner—Brian N. Vinson  
Attorney, Agent, or Firm—Quarles & Brady

[57] CLAIM

The ornamental design for a shelf mount, as shown and described.

DESCRIPTION

FIG. 1 is a top, front, and right side perspective view of a shelf mount showing my new design;  
 FIG. 2 is a front elevational view thereof, the fragmentary broken-line disclosure of a portion of a shelf being for illustrative purposes only and forming no part of the claimed design;  
 FIG. 3 is a top plan view thereof;  
 FIG. 4 is a right side elevational view thereof, the left side being a mirror image of that shown;  
 FIG. 5 is a bottom plan view thereof;  
 FIG. 6 is a top, front, and right side perspective view of a second embodiment thereof, the only difference residing in the side elevations;  
 FIG. 7 is a right side elevational view of the embodiment of FIG. 6;  
 FIG. 8 is a left side elevational view of the embodiment of FIG. 6; and,  
 FIG. 9 is a top, front, and left side perspective view of a third embodiment thereof, the only difference being that the third embodiment is a mirror image of the second.

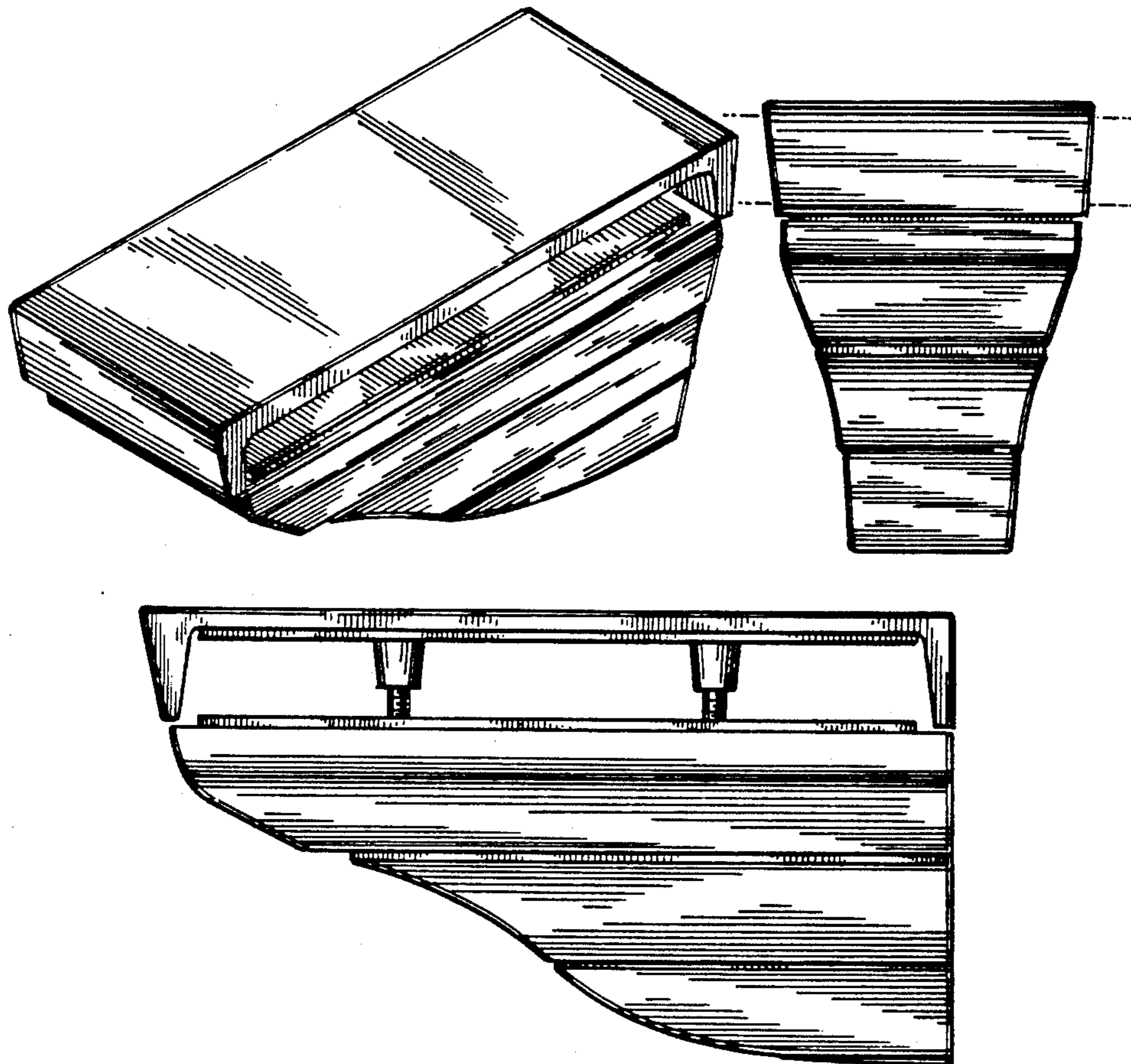

FIG. 1

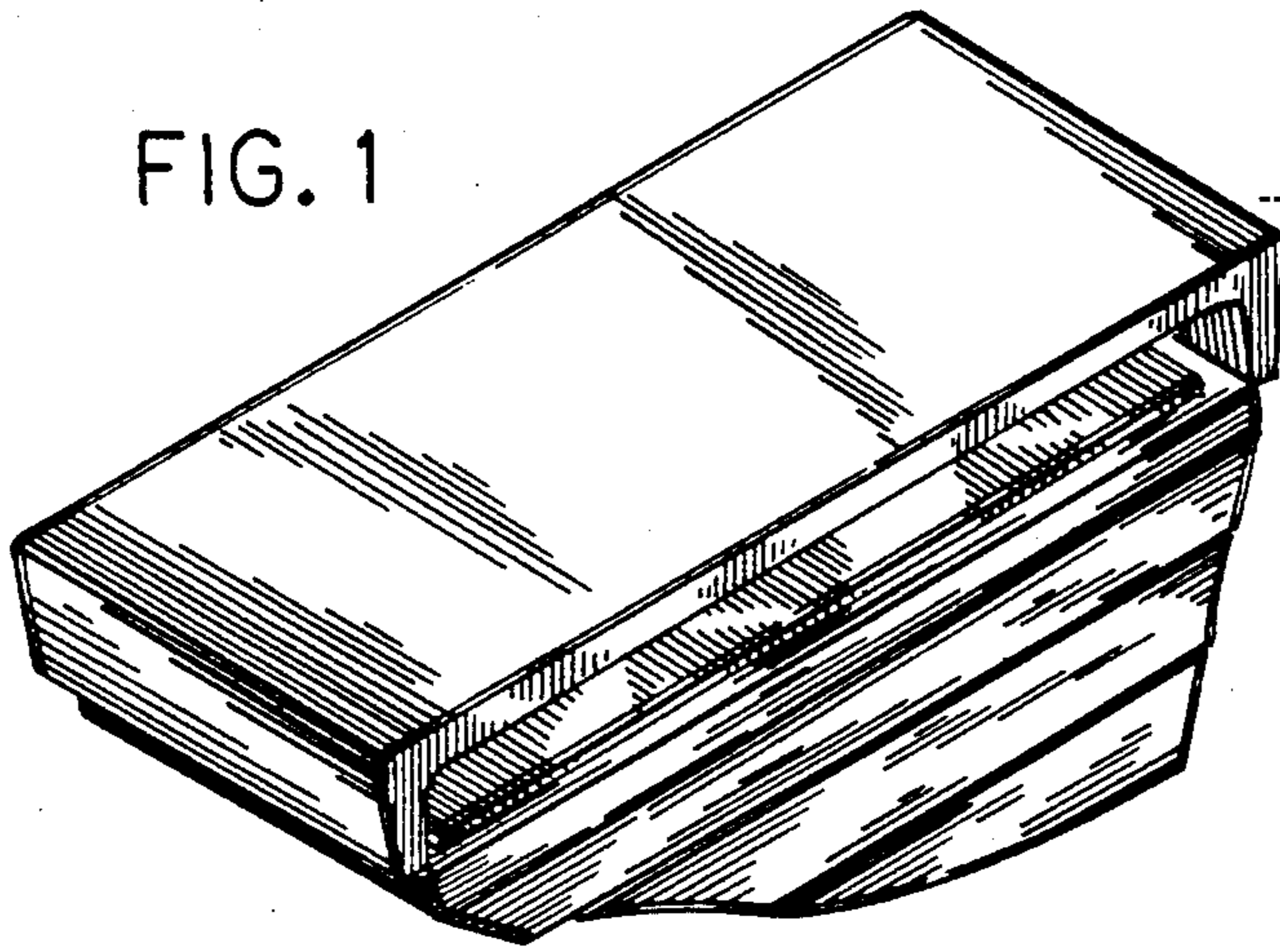

FIG. 2

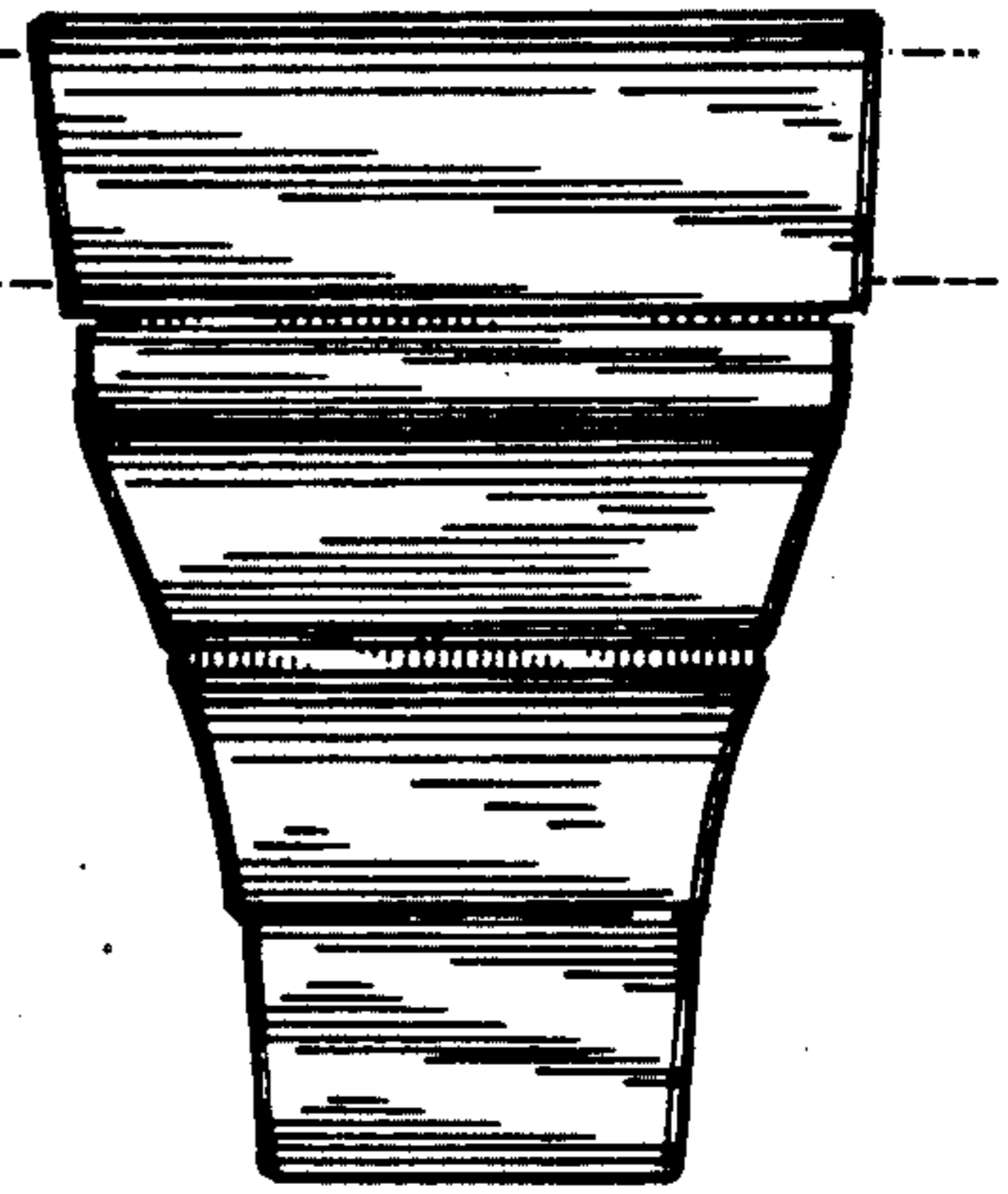

FIG. 3

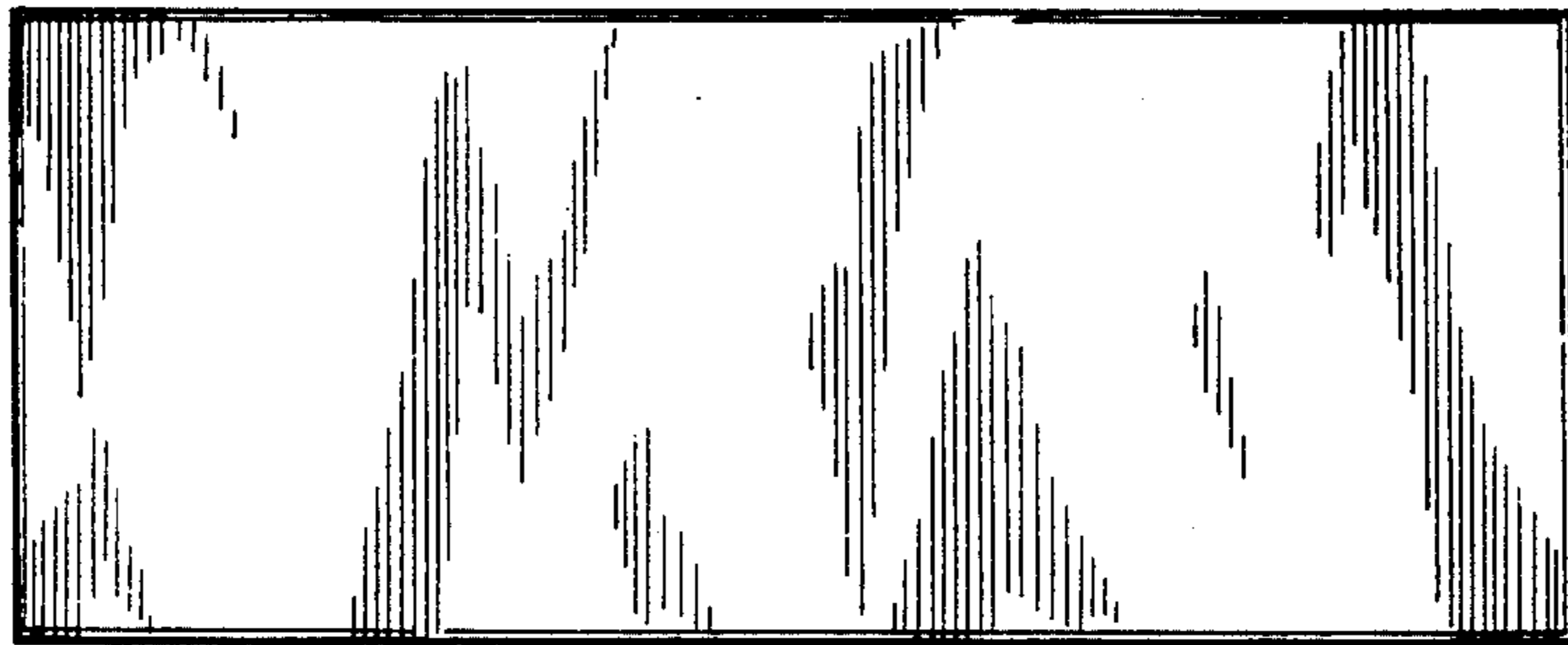

FIG. 4

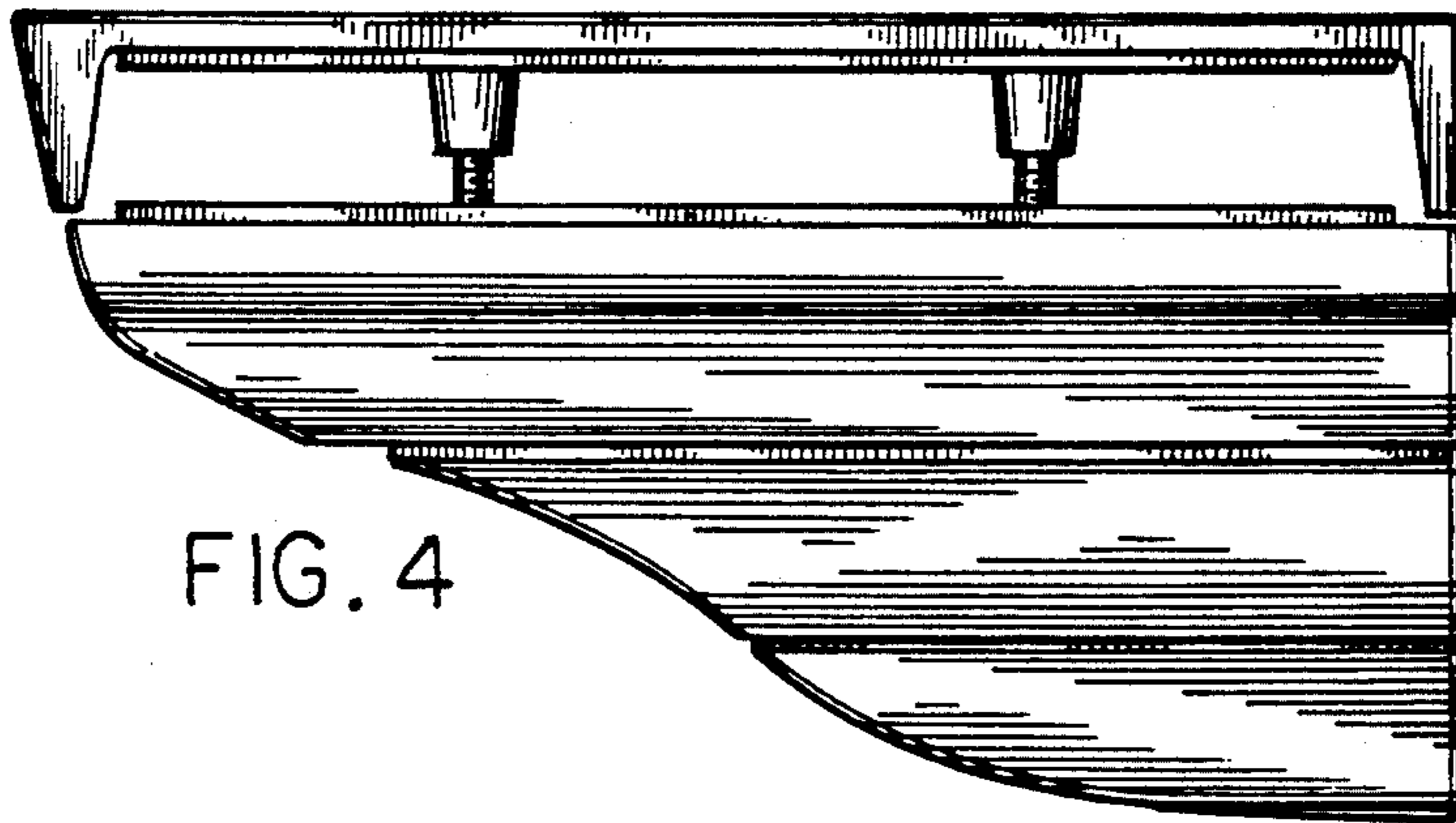
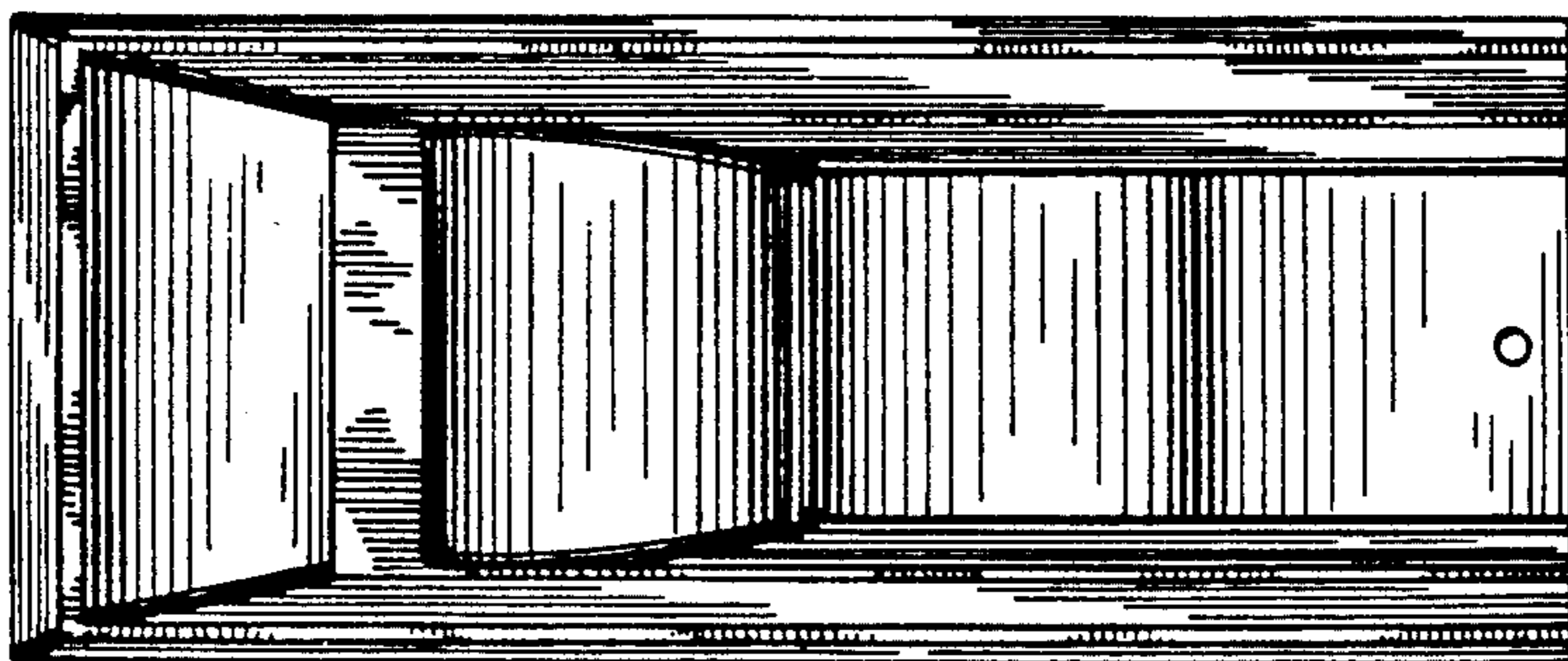

FIG. 5





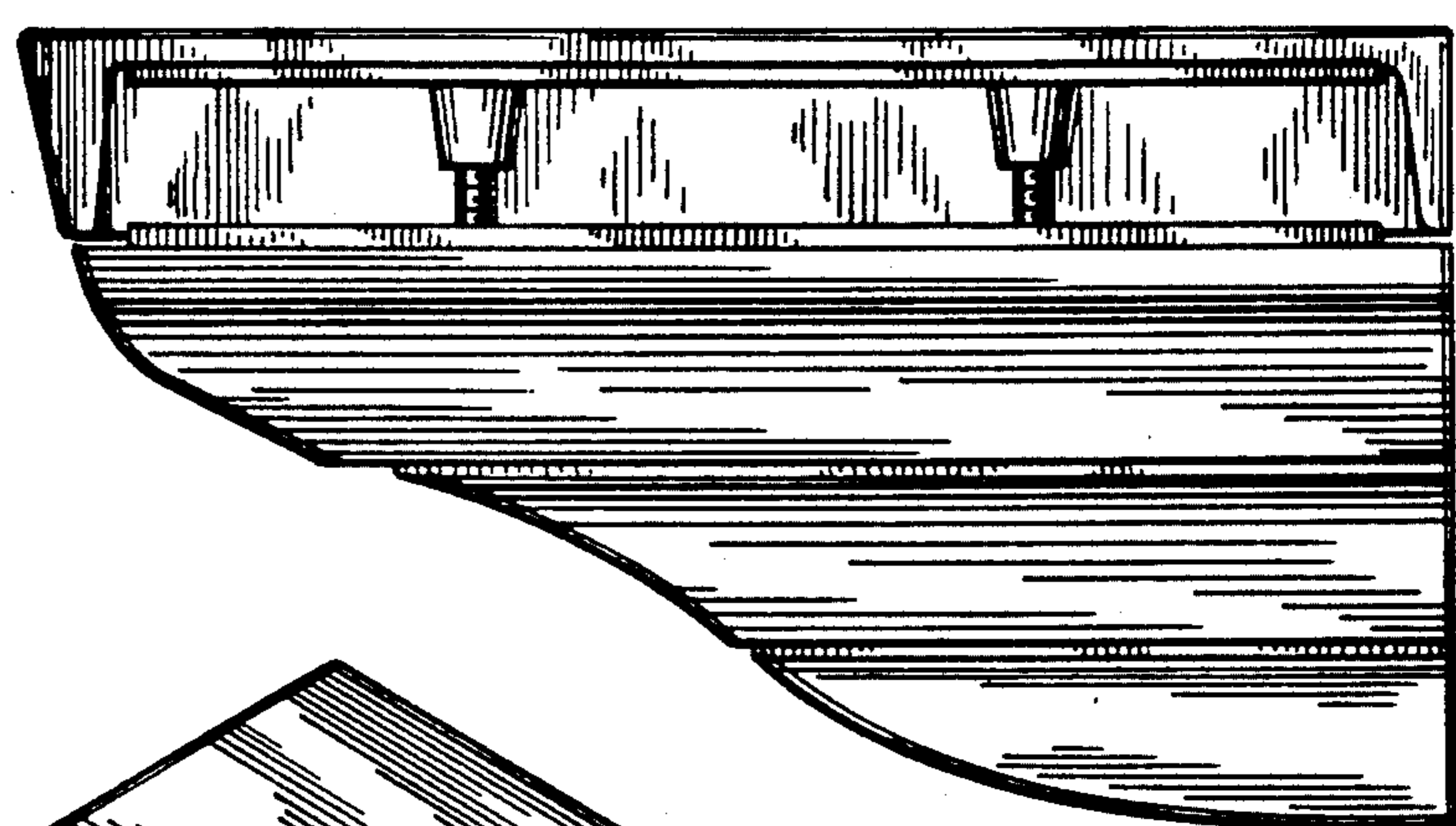

FIG. 7

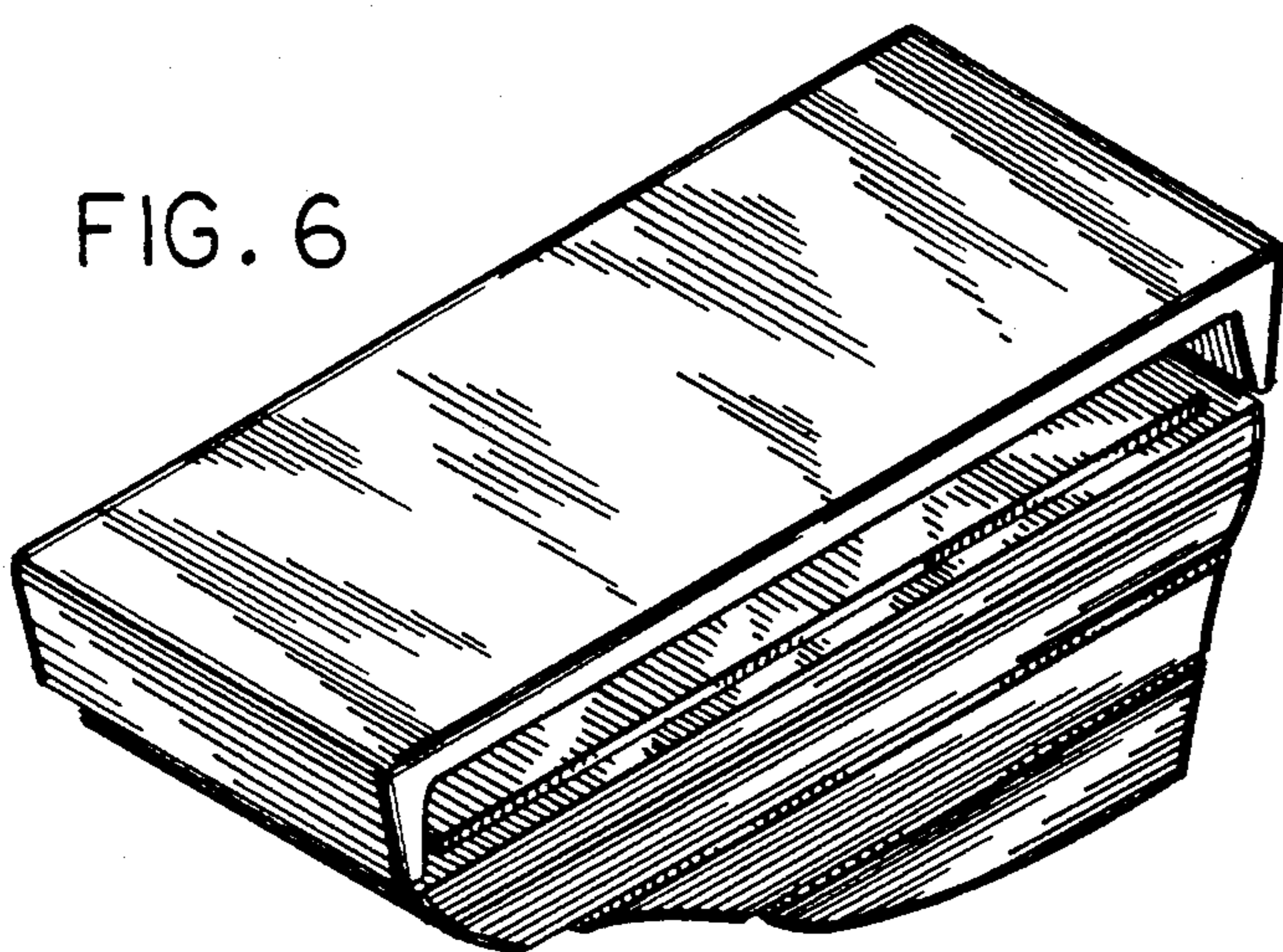

FIG. 6



FIG. 8

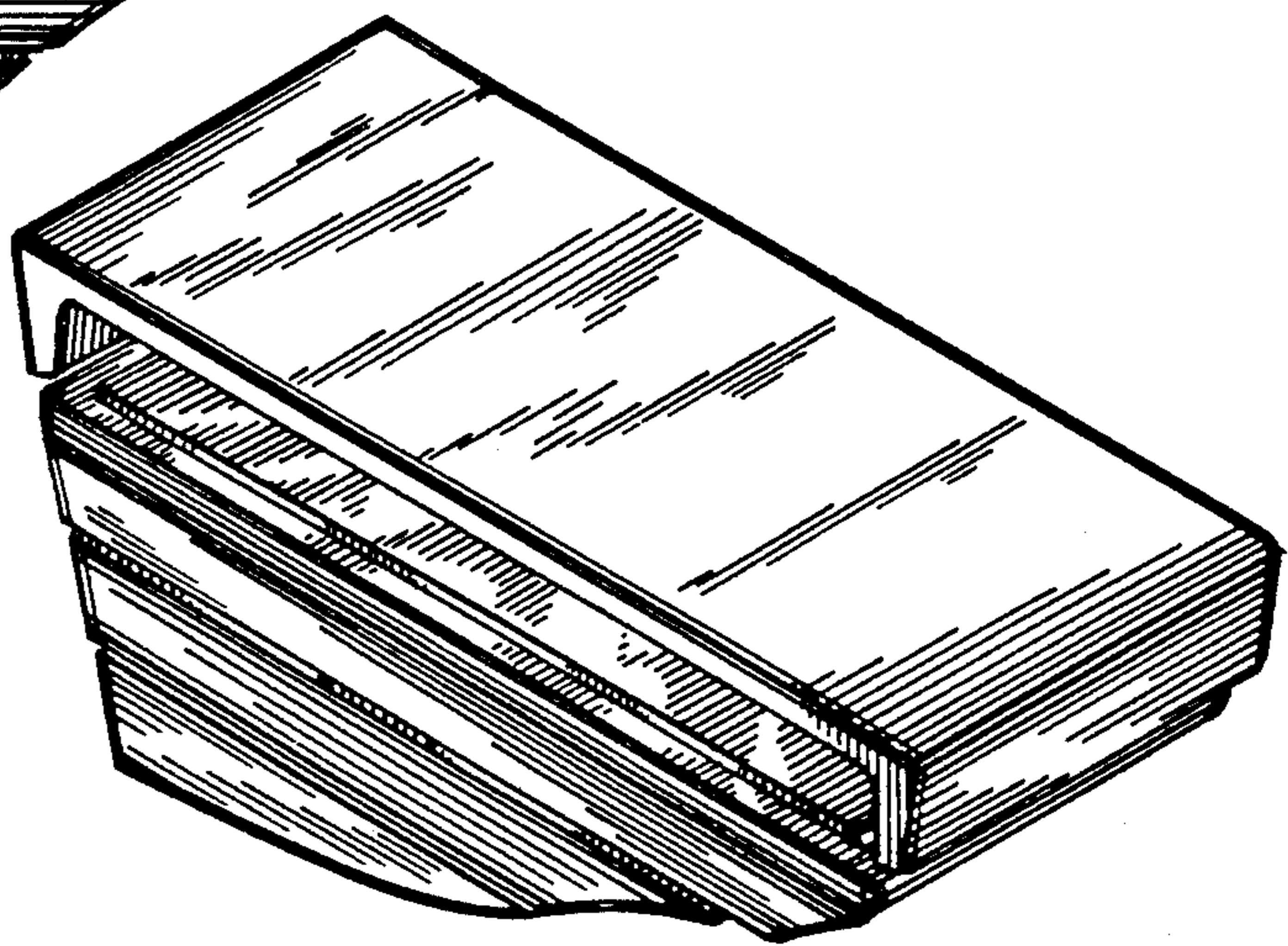

FIG. 9