



US00D333249S

United States Patent [19]

Ciccone, III et al.

[11] Patent Number: **Des. 333,249**

[45] Date of Patent: **** Feb. 16, 1993**

[54] **HANDGRIP FOR A HACKSAW ASSEMBLY**

3,815,648 6/1974 Dreier 30/513
4,349,059 9/1982 Hepworth et al. 30/513

[75] Inventors: **Theodore P. Ciccone, III**, West Hartford; **Joseph P. DeCarolis**, Bristol, both of Conn.

[73] Assignee: **The Stanley Works**, New Britain, Conn.

[**] Term: **14 Years**

[21] Appl. No.: **664,973**

[22] Filed: **Mar. 5, 1991**

[52] U.S. Cl. **D8/97**

[58] Field of Search **D8/95, 97, 107; 30/510, 30/511, 513, 514, 517, 506, 339**

[56] **References Cited**

U.S. PATENT DOCUMENTS

D. 176,770	1/1956	Jacoff	30/511
D. 259,328	5/1981	Covey	D8/97
D. 260,072	8/1981	Covey	D8/97
D. 269,848	7/1983	Covey	D8/97
2,546,660	3/1951	Wilcox	30/511
3,173,461	3/1965	Johnson	30/510

OTHER PUBLICATIONS

Stanley Tools Catalog, 1980, 11A14, p. 33, Saws.

Primary Examiner—Bernard Ansher

Assistant Examiner—Philip S. Hyder

[57] **CLAIM**

The ornamental design for a handgrip for a hacksaw assembly, as shown and described.

DESCRIPTION

FIG. 1 is a right side elevational view of a handgrip for a hacksaw assembly showing our new design; FIG. 2 is a front elevational view thereof; FIG. 3 is a rear elevational view thereof; FIG. 4 is a top plan view thereof; FIG. 5 is a bottom view thereof; FIG. 6 is a cross sectional view along the line 6—6 of FIG. 1; and, FIG. 7 is a left side elevational view thereof, the broken line portions of the drawing being for illustrative purposes only and form no part of the claimed design.

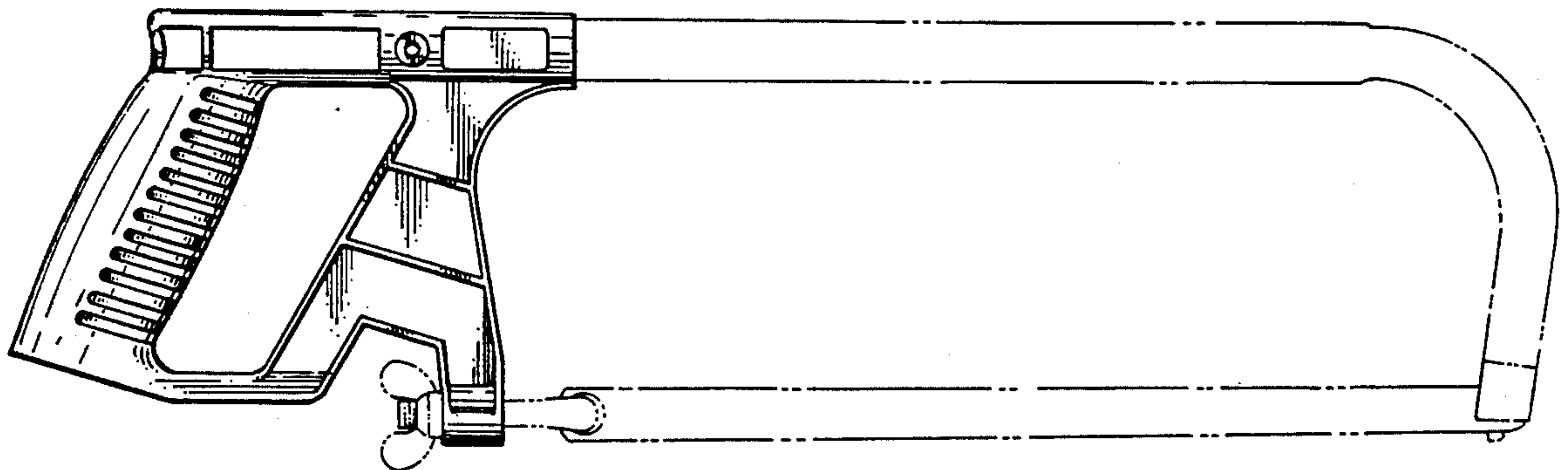

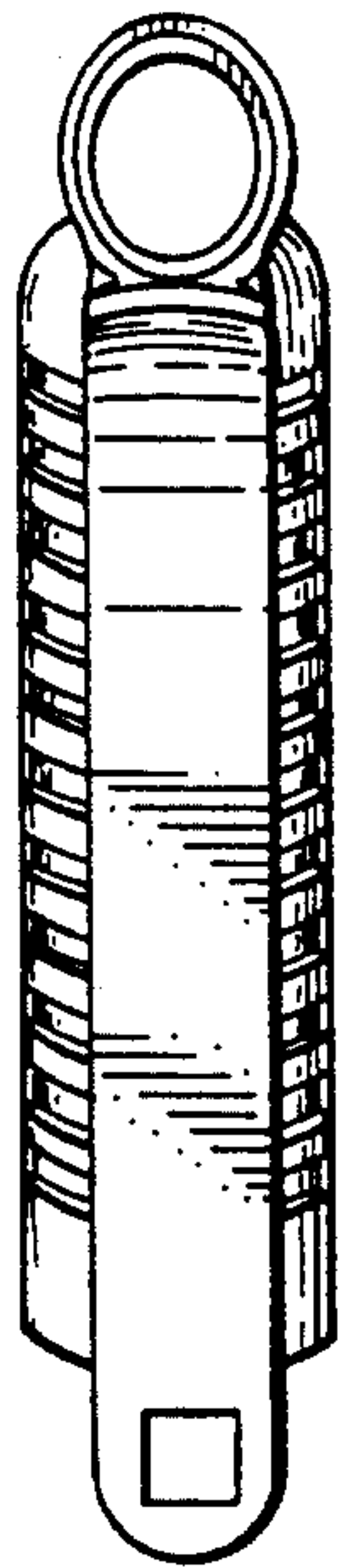

FIG. 2

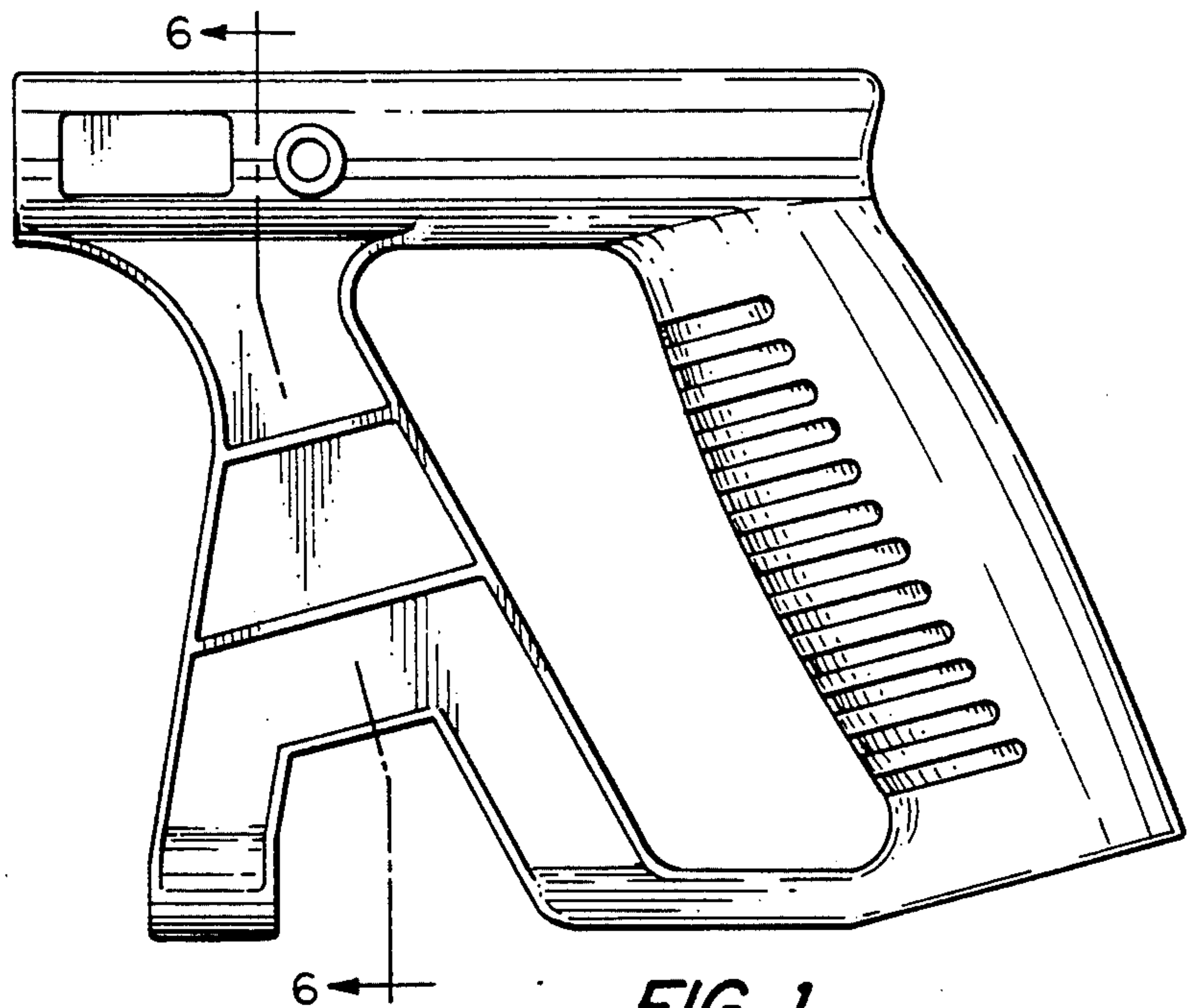

FIG. 1

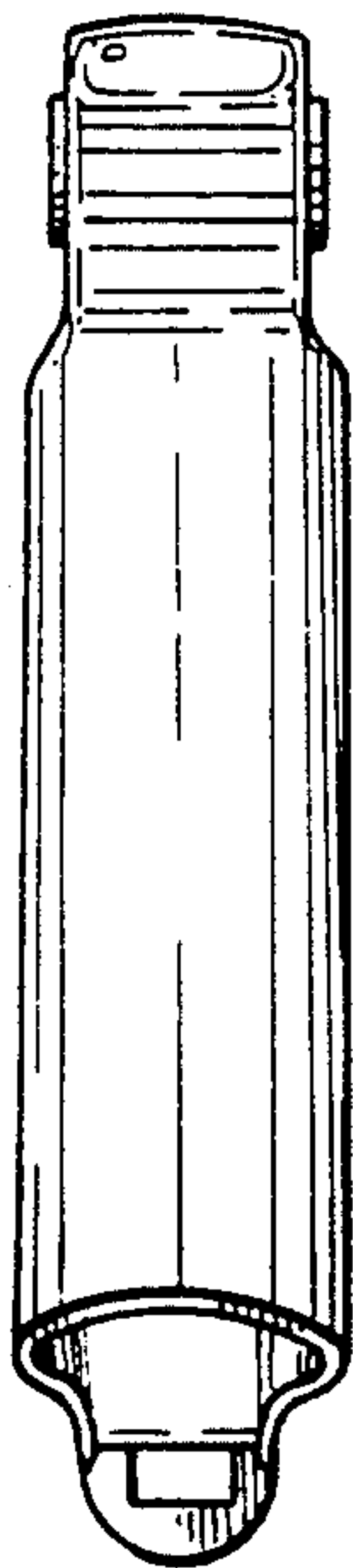

FIG. 3

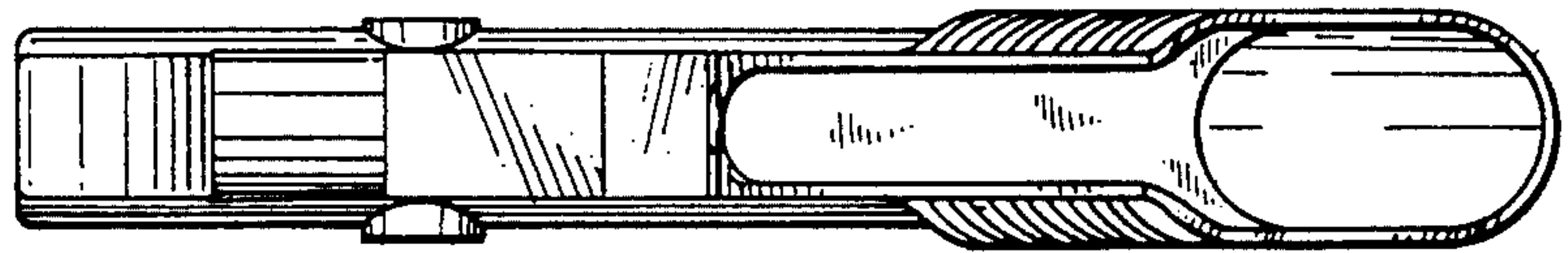

FIG. 5

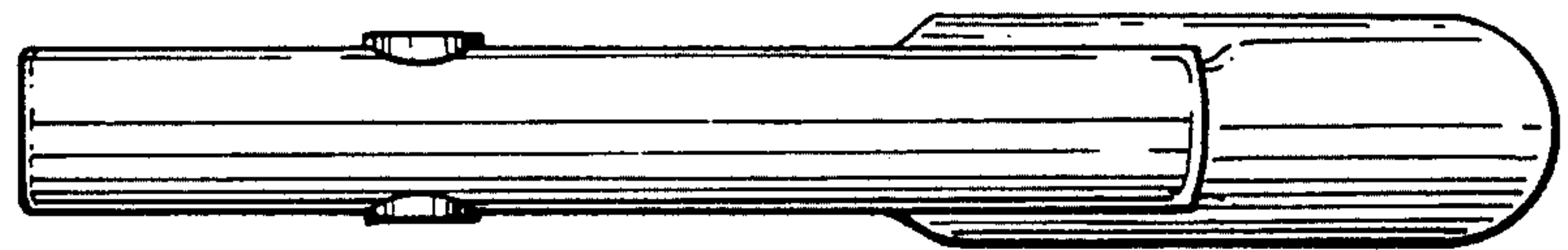

FIG. 4



FIG. 6

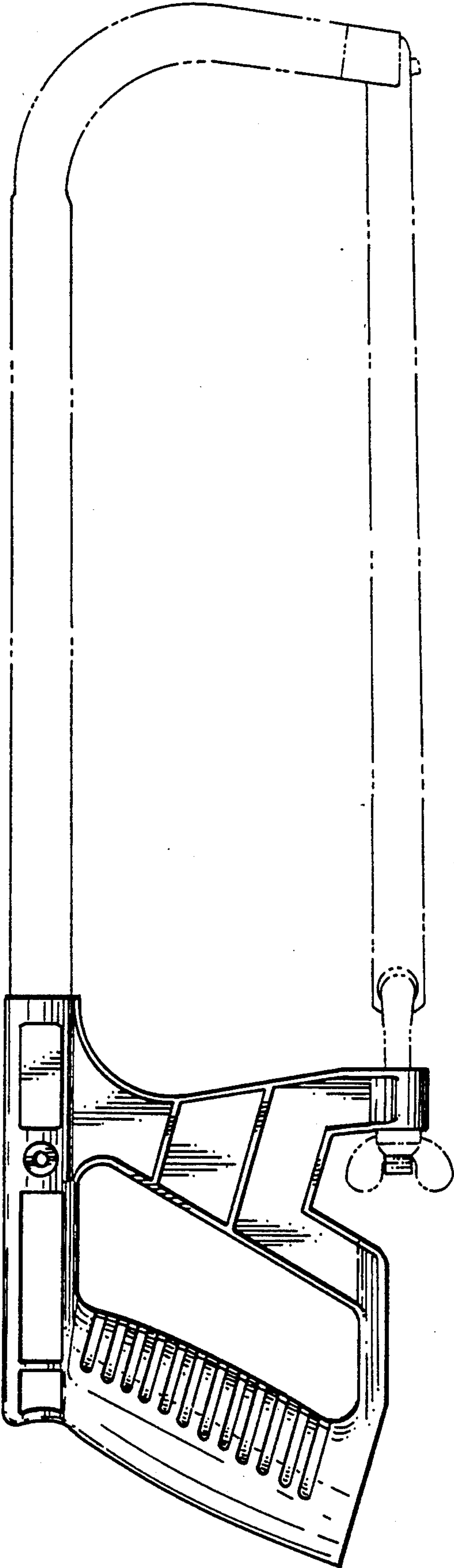

FIG. 7