



US00D333234S

United States Patent [19]

[11] Patent Number: Des. 333,234

Nichols

[45] Date of Patent: ** Feb. 16, 1993

[54] STOVE

[76] Inventor: Luella V. Nichols, 250 Sky Acres Dr., Stowe, Vt. 05672

[**] Term: 14 Years

[21] Appl. No.: 611,155

[22] Filed: Nov. 9, 1990

[52] U.S. Cl. D7/340

[58] Field of Search D7/323, 339-341, D7/346-348; 126/39 B, 39 C, 39 R, 19 R, 273 R, 50

[56] References Cited

U.S. PATENT DOCUMENTS

D. 162,974	4/1951	Morgan et al.	D7/340
D. 193,822	10/1962	Clark et al.	D7/340
D. 200,890	4/1965	Johannes	D7/340
D. 201,233	5/1965	Dunbar	D7/340
D. 314,305	2/1991	Wright	D7/340
3,923,037	12/1975	Donato	126/39 C
4,598,691	7/1986	Herrelko et al.	126/39 C

Primary Examiner—A. Hugo Word
Assistant Examiner—Ruth McInroy
Attorney, Agent, or Firm—Leon Gilden

[57] CLAIM

The ornamental design for a stove, as shown and described.

DESCRIPTION

FIG. 1 is a front elevational view of a stove showing my new design;
 FIG. 2 is a rear elevational view thereof;
 FIG. 3 is a left side elevational view thereof;
 FIG. 4 is a right side elevational view thereof;
 FIG. 5 is a top plan view thereof;
 FIG. 6 is a bottom plan view thereof;
 FIG. 7 is a front elevational view of a second embodiment thereof;
 FIG. 8 is a rear elevational view thereof;
 FIG. 9 is a left side elevational view thereof;
 FIG. 10 is a right side elevational view thereof;
 FIG. 11 is a top plan view thereof; and,
 FIG. 12 is a bottom plan view thereof.

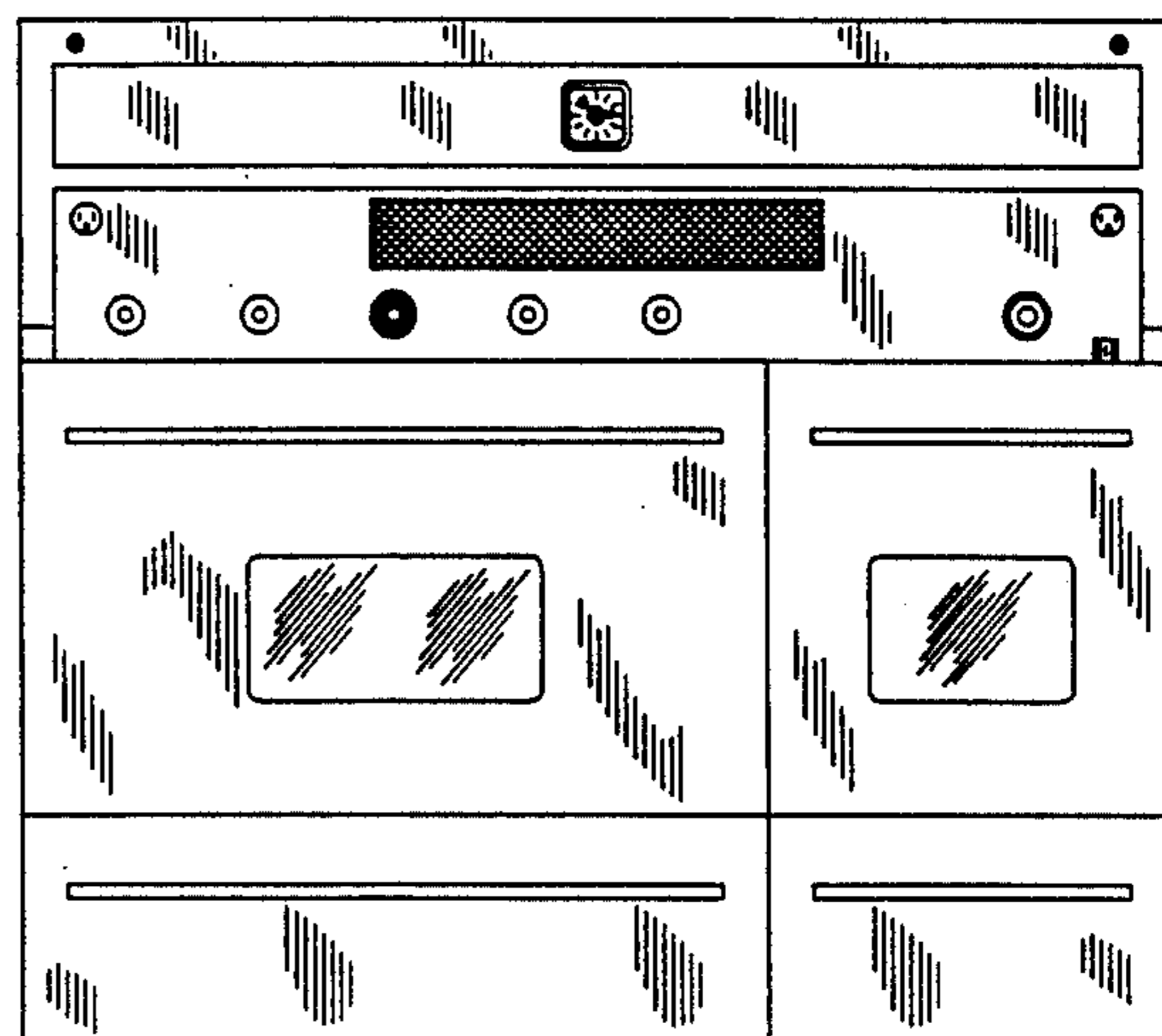
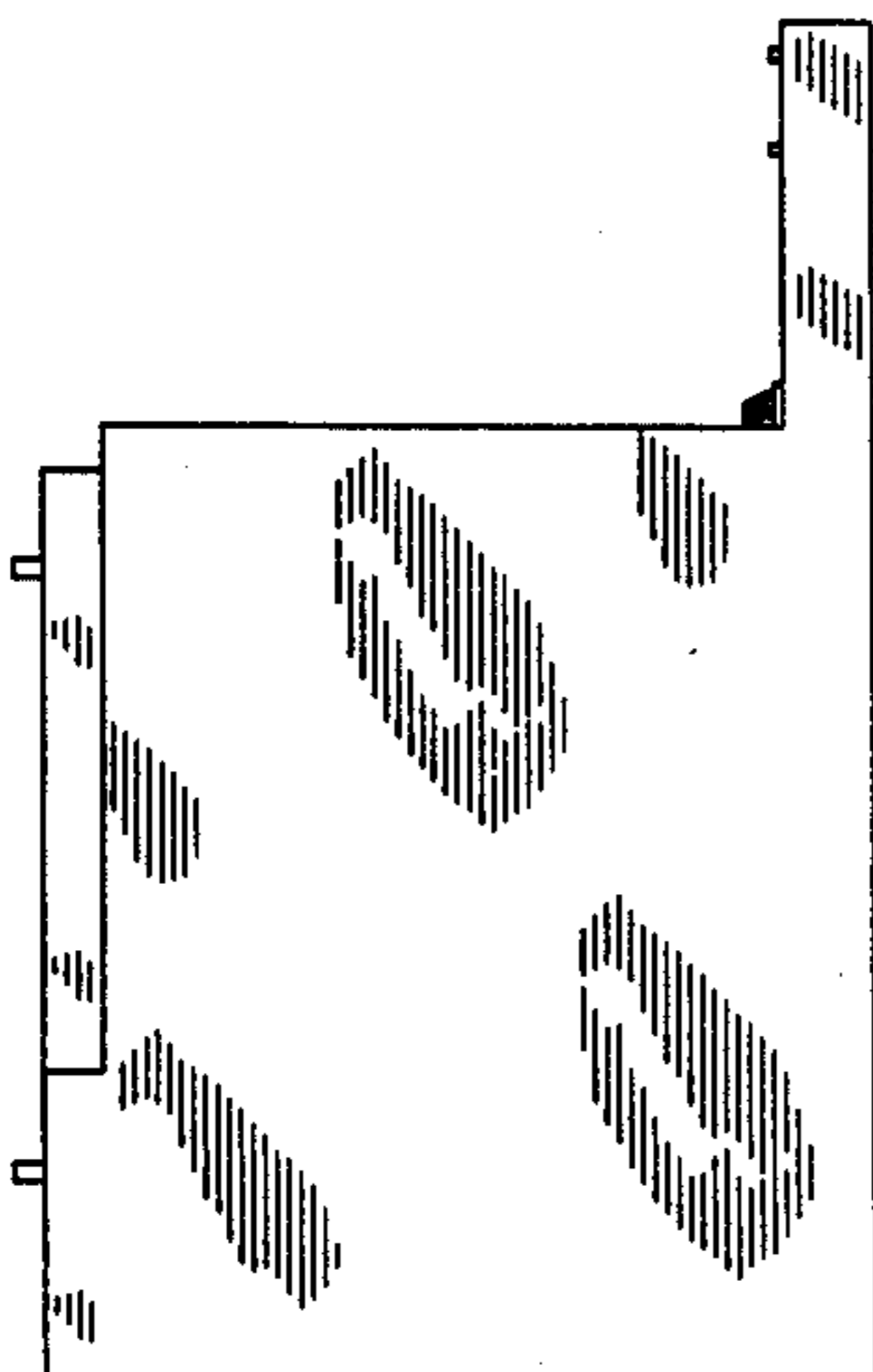
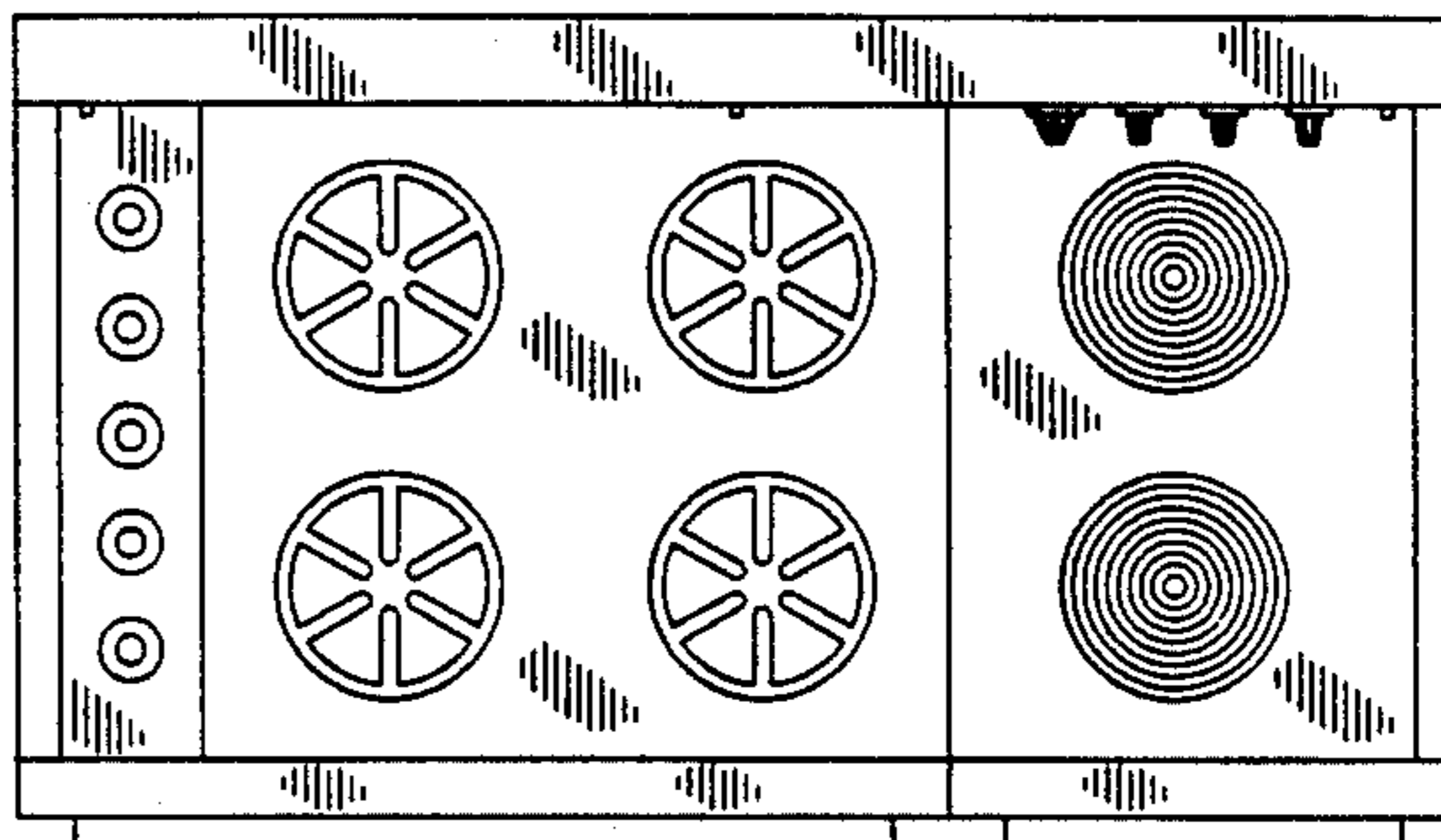
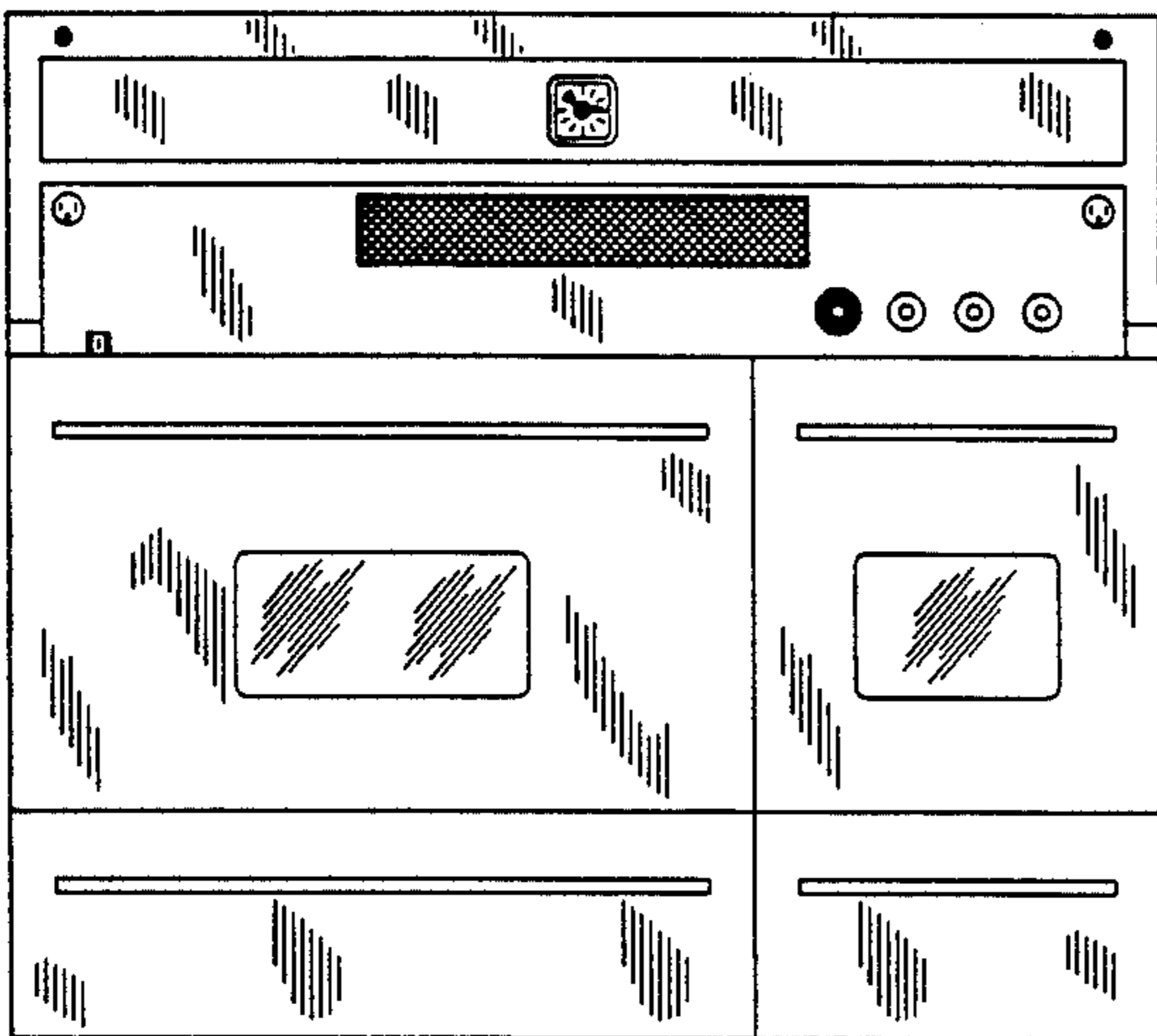

FIG. 1

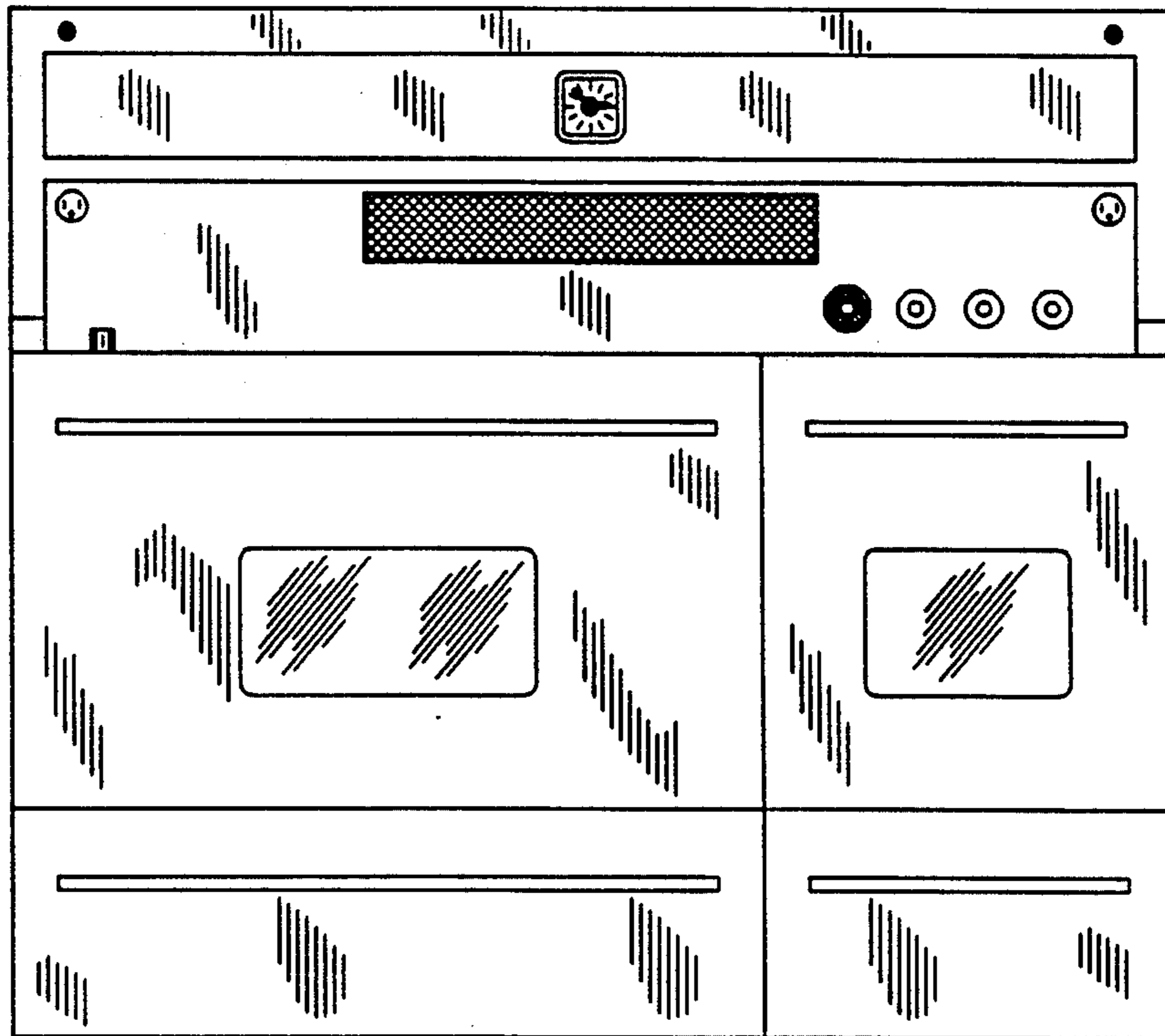

FIG. 2

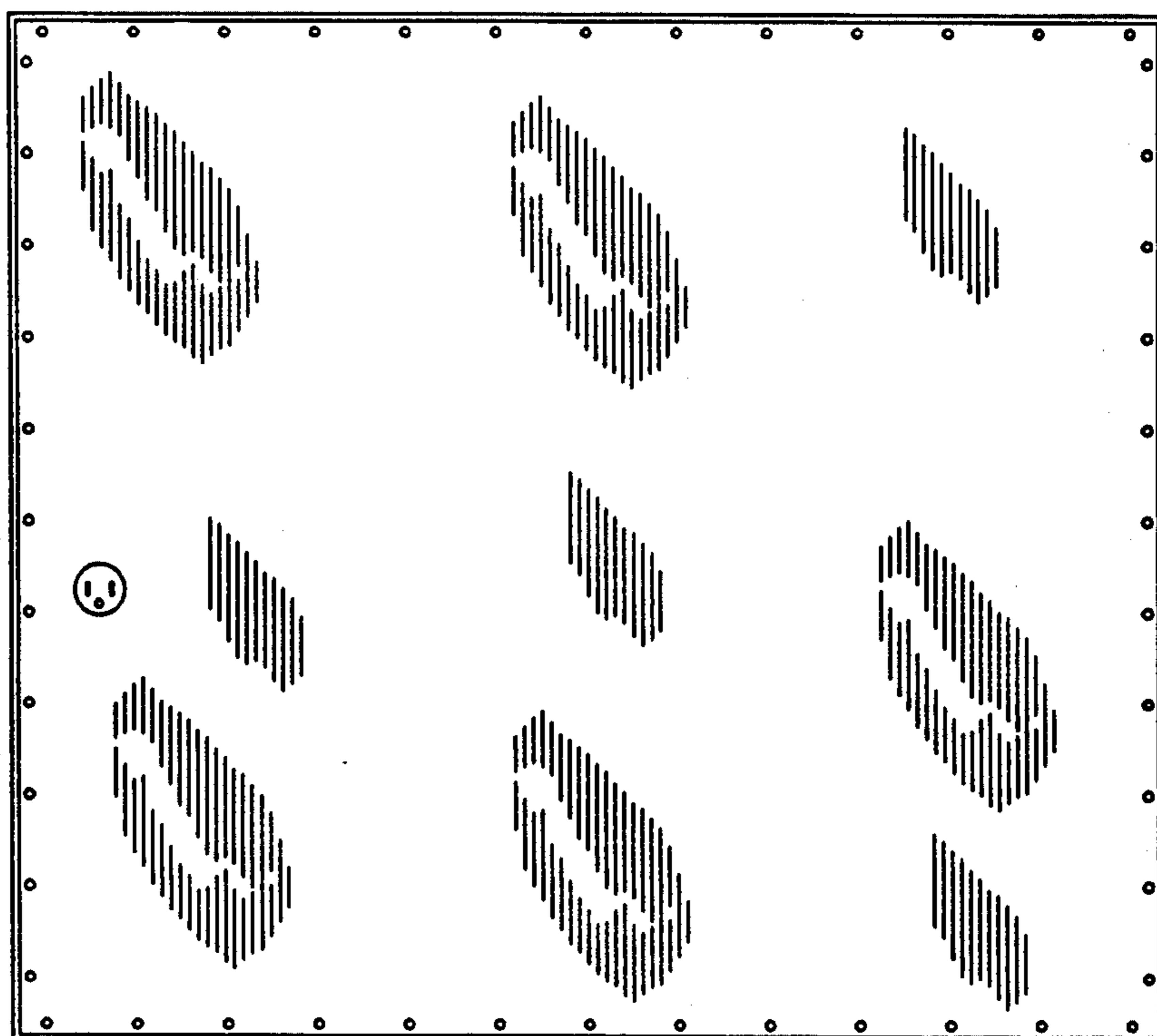

FIG. 3

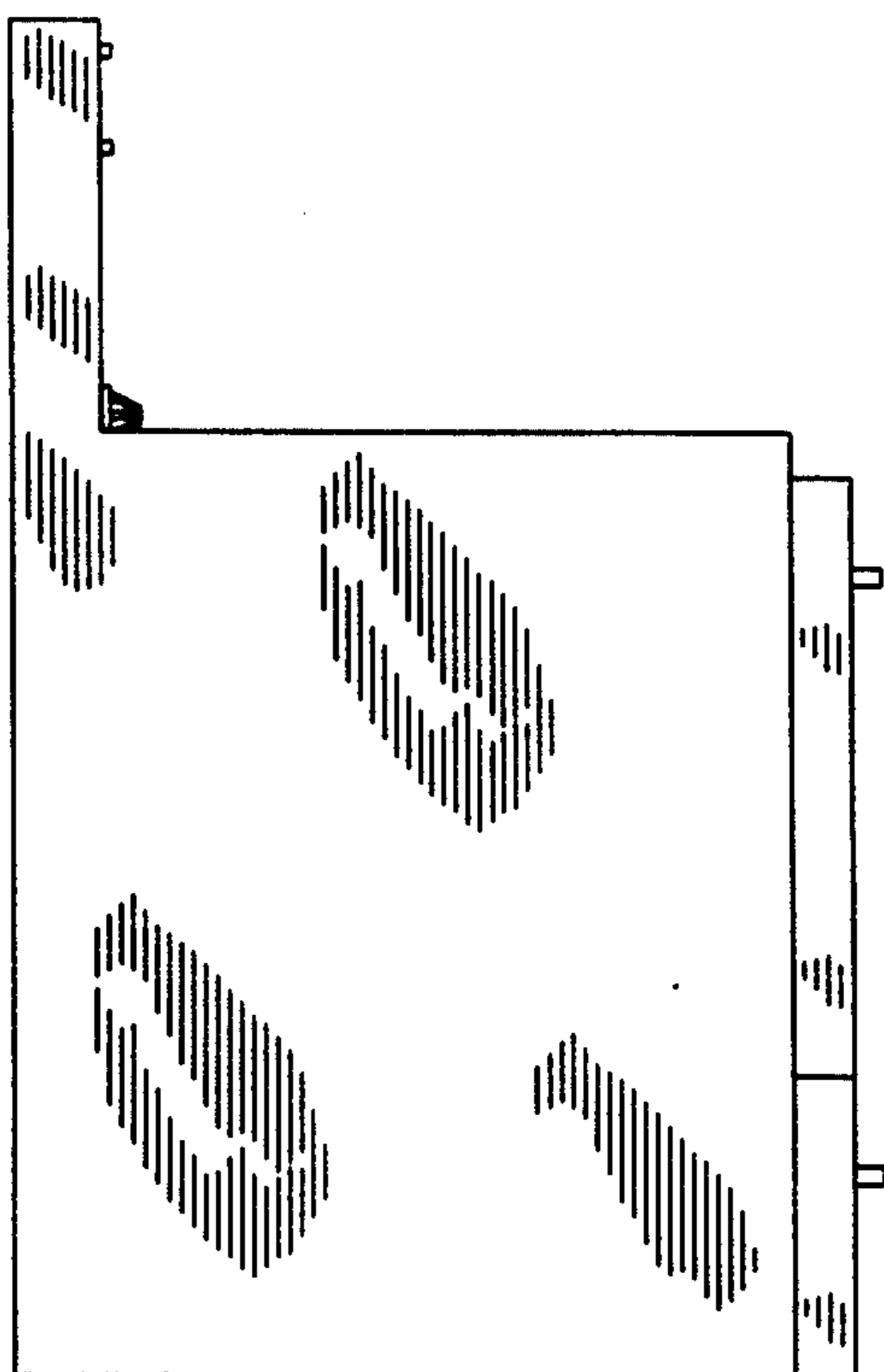

FIG. 4

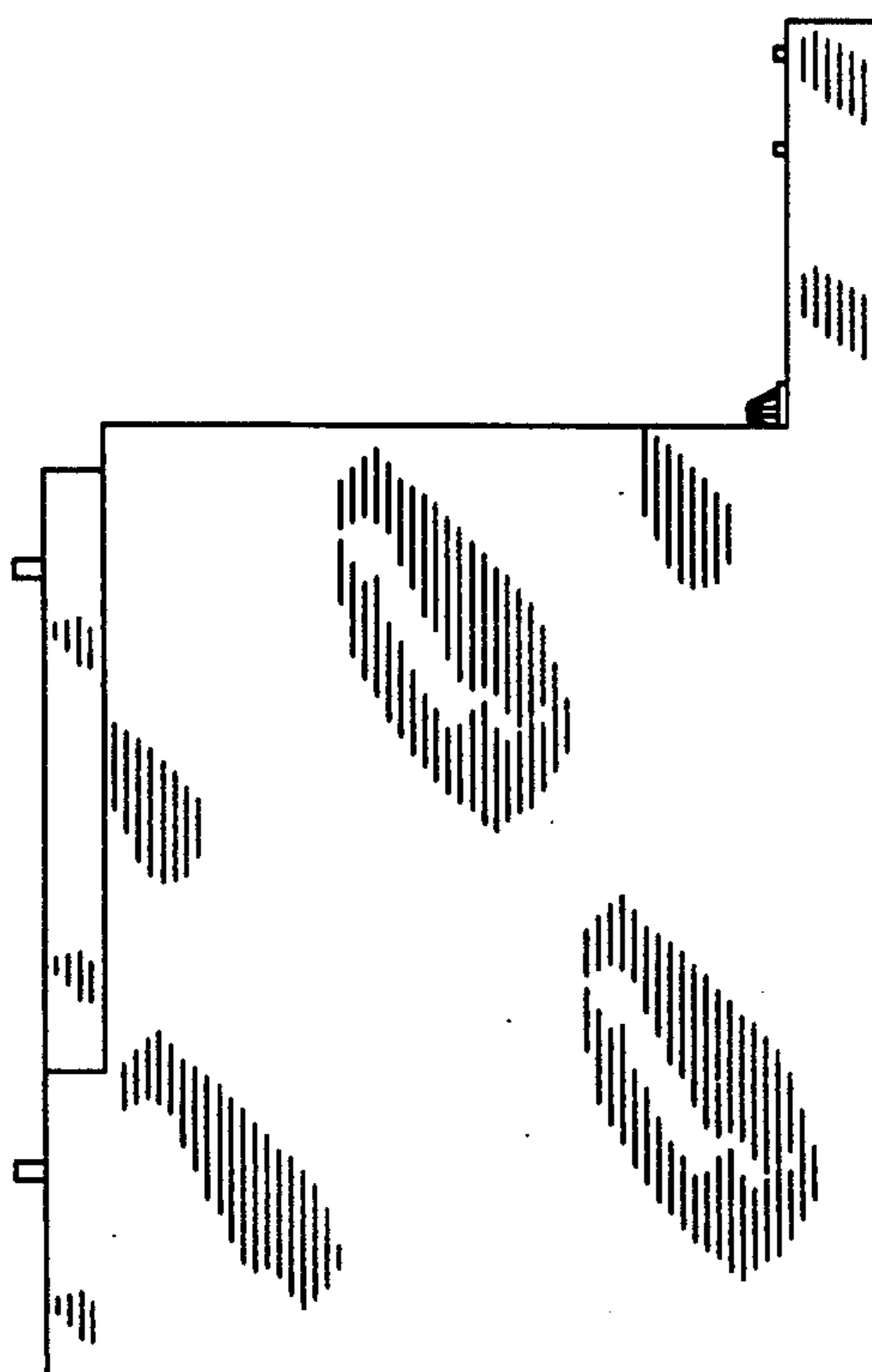

FIG. 5

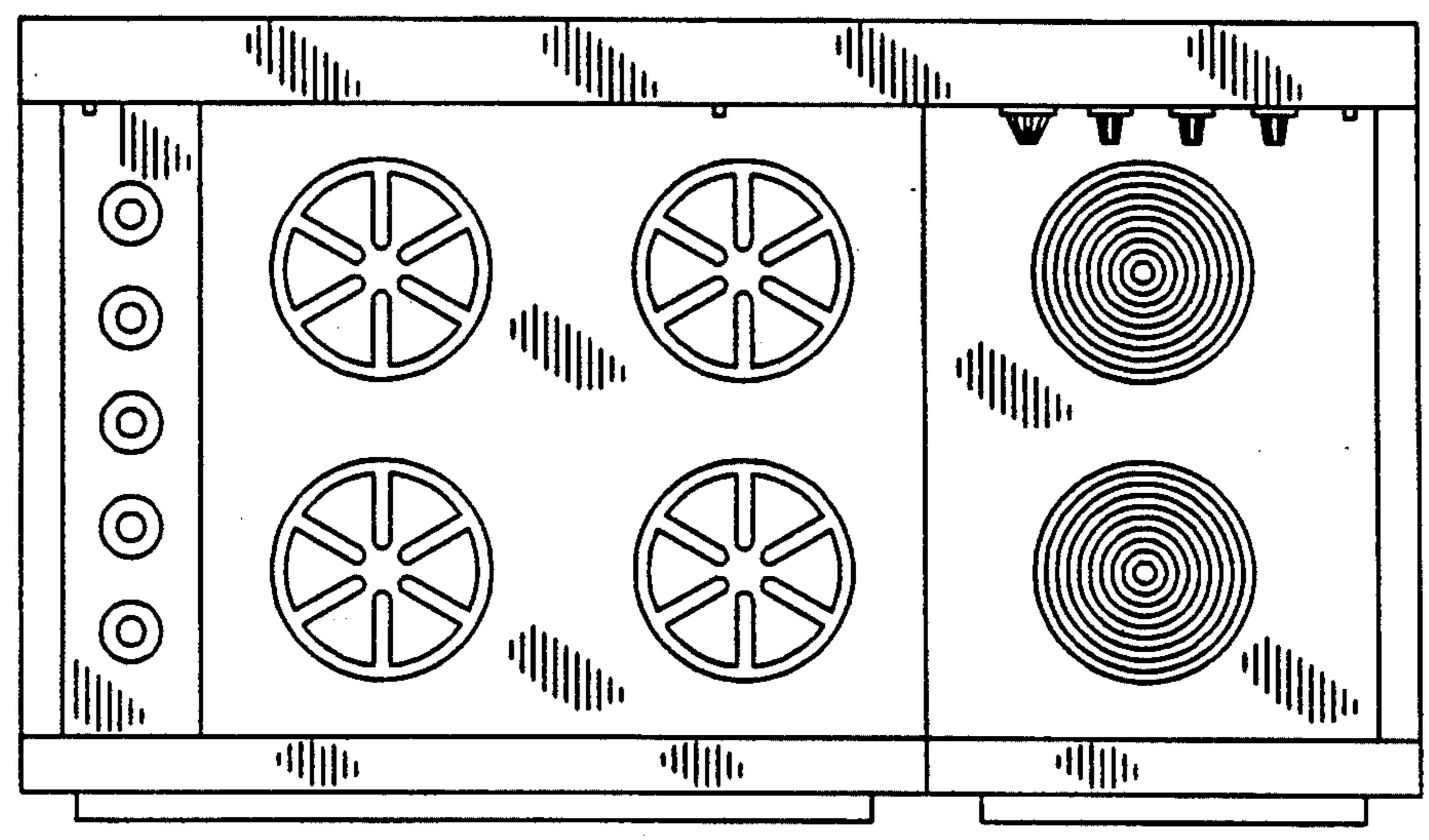

FIG. 6

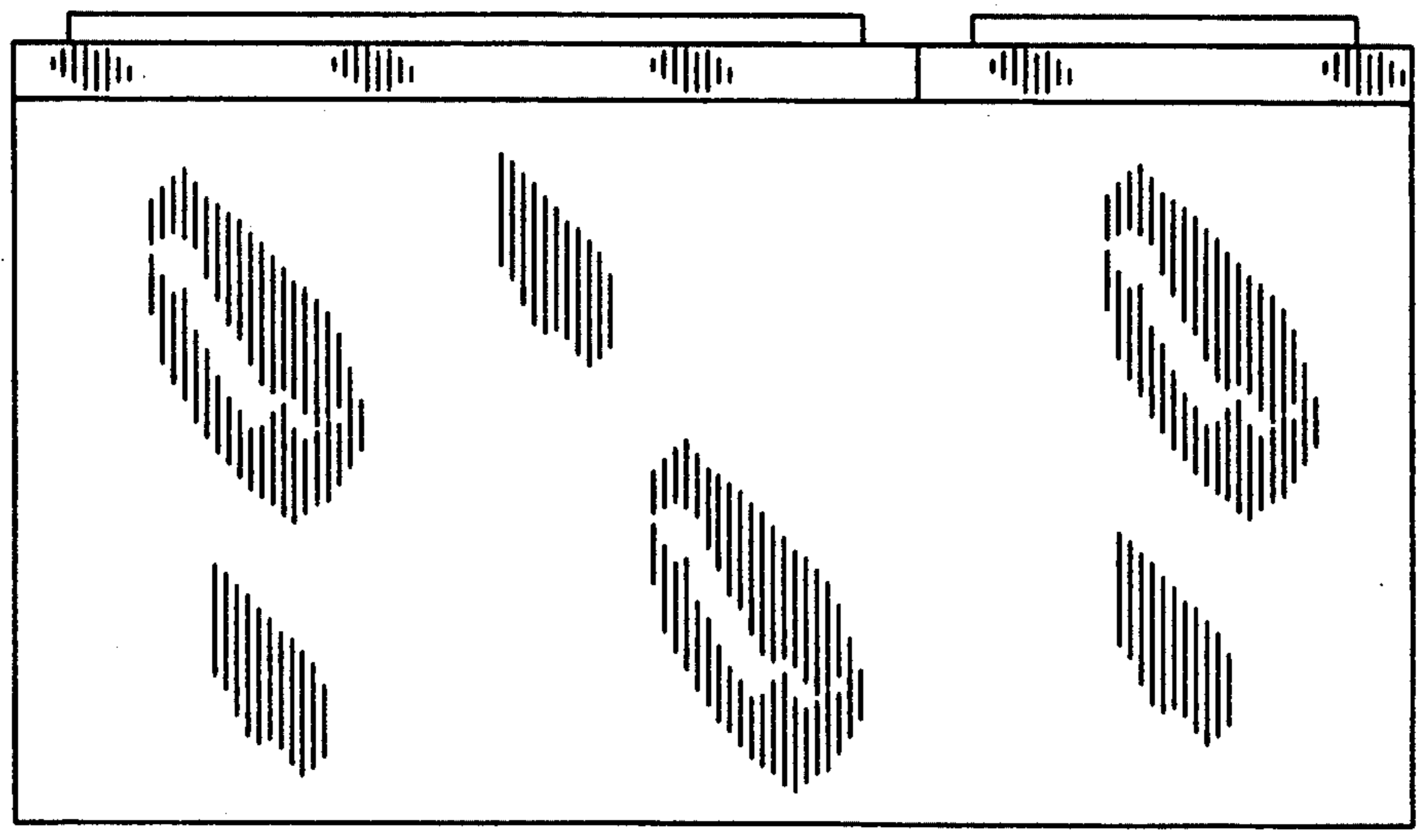

FIG. 7

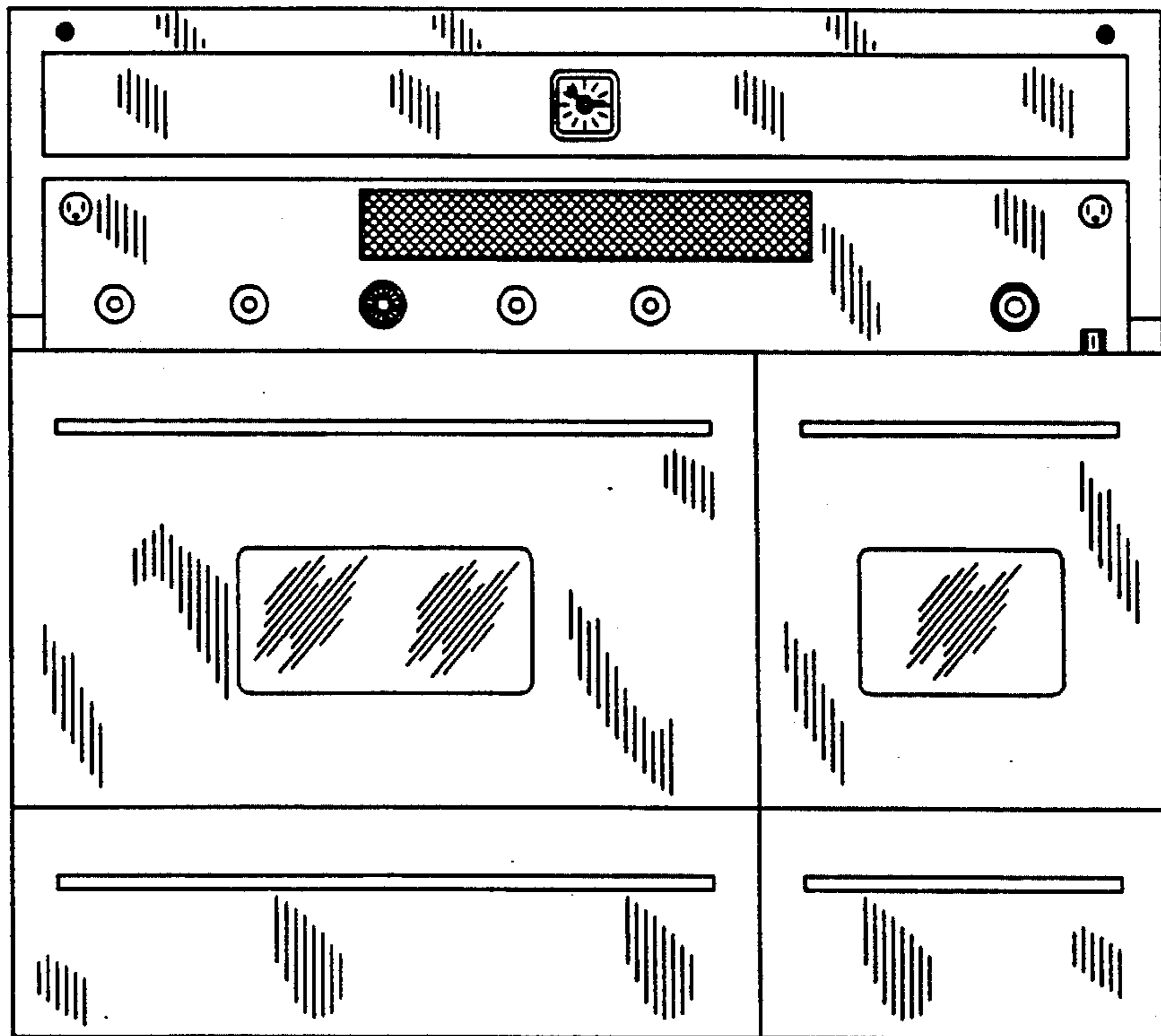

FIG. 8

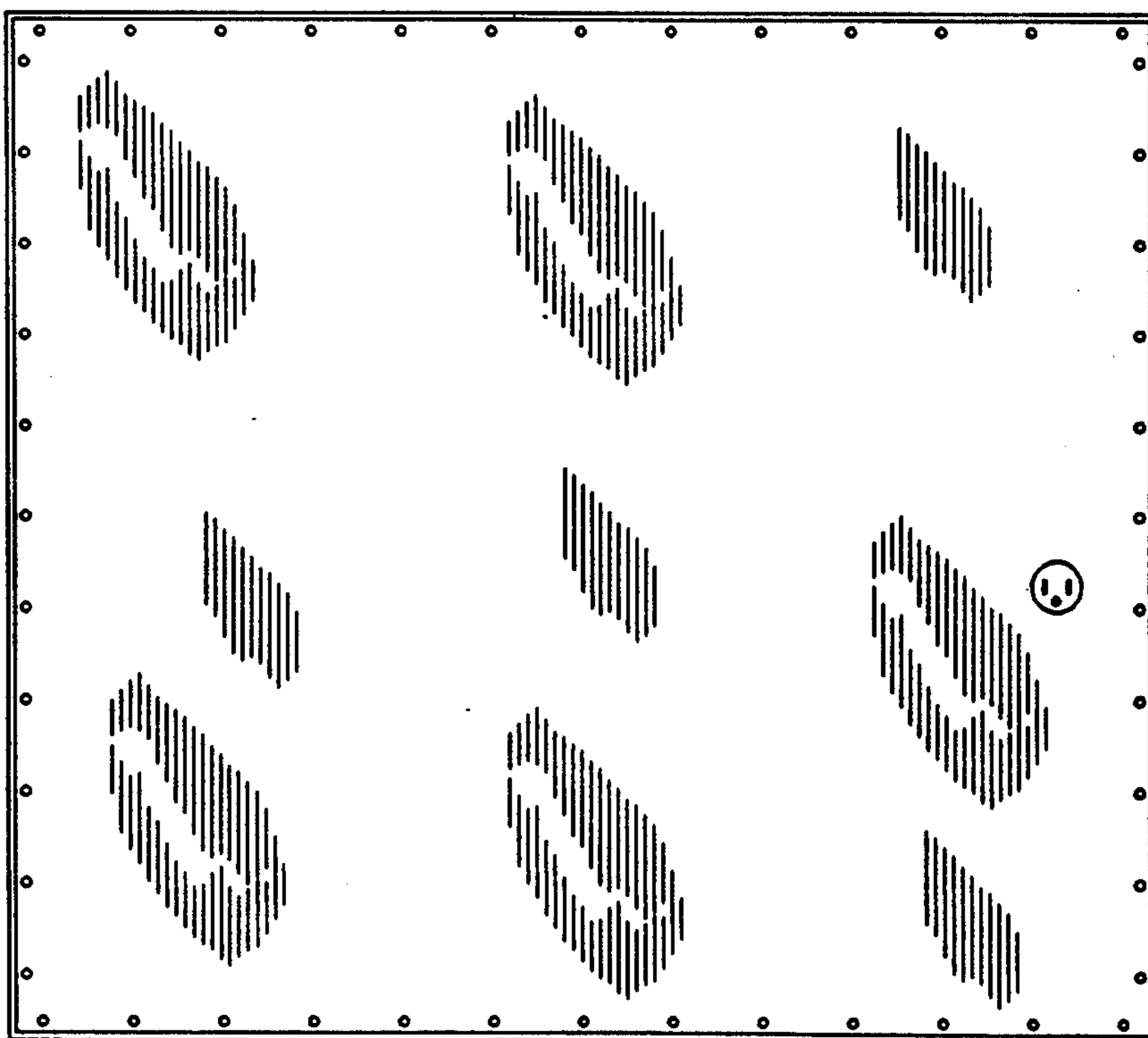

FIG. 9

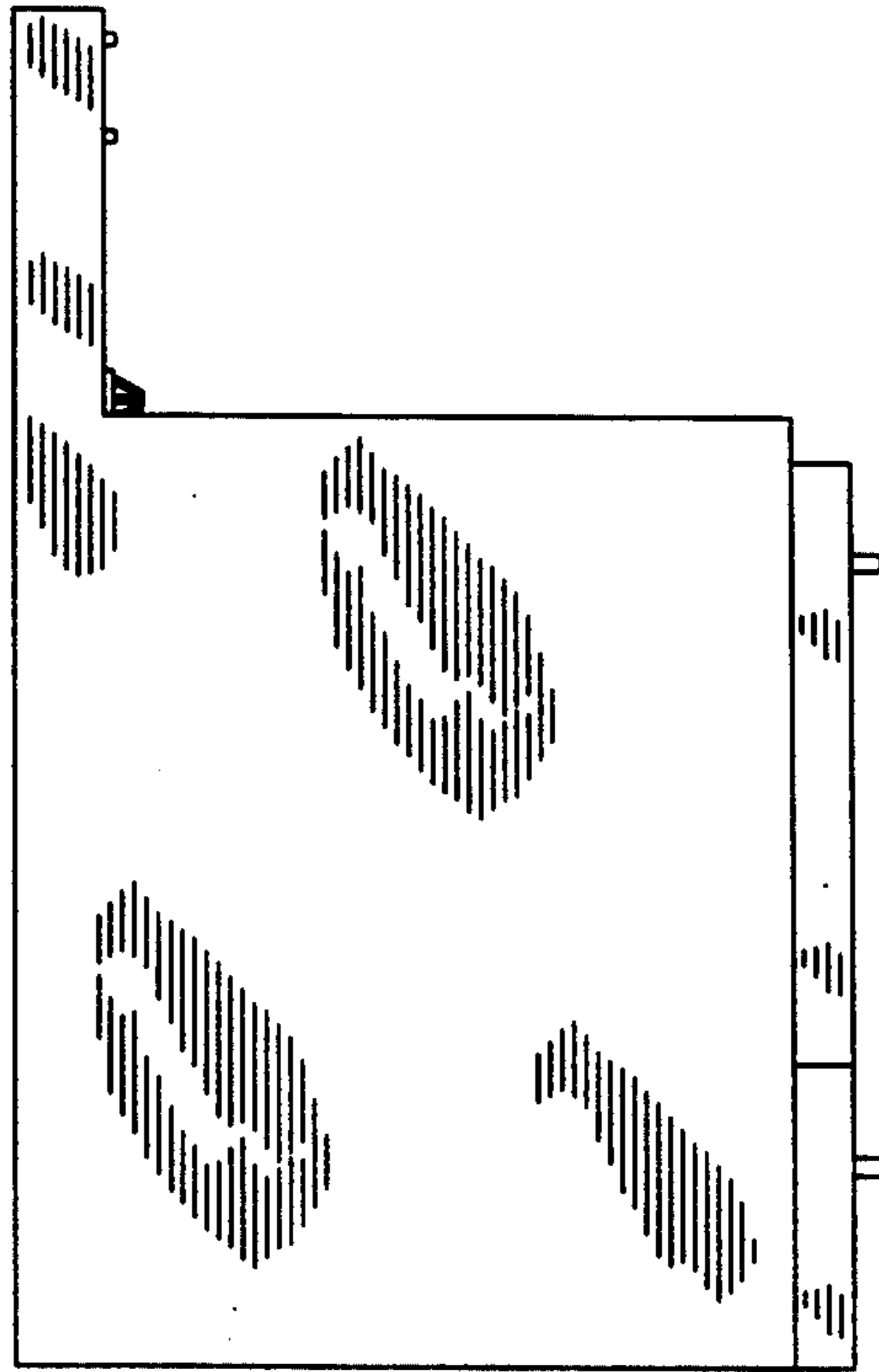

FIG. 10

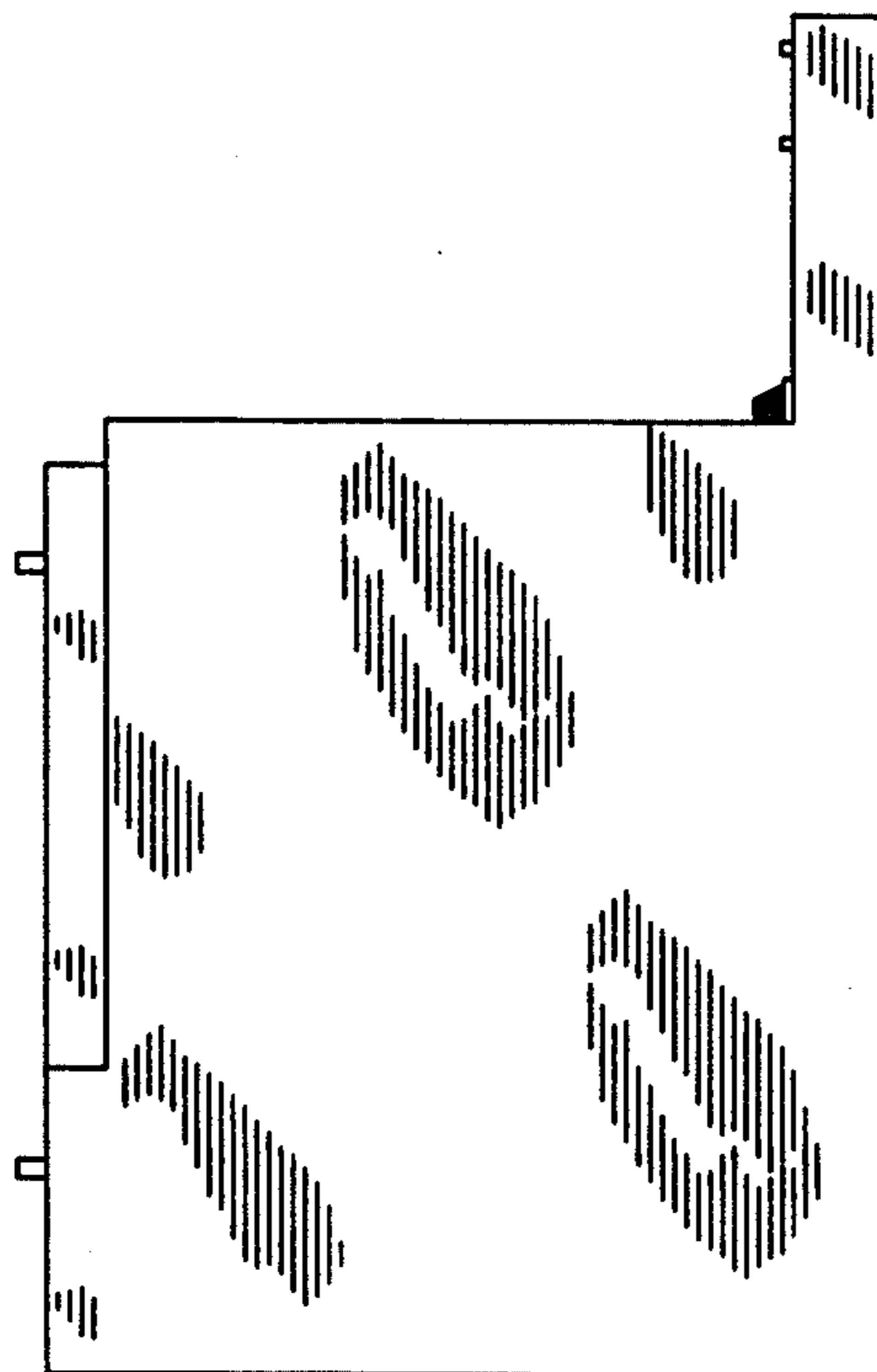

FIG. 11

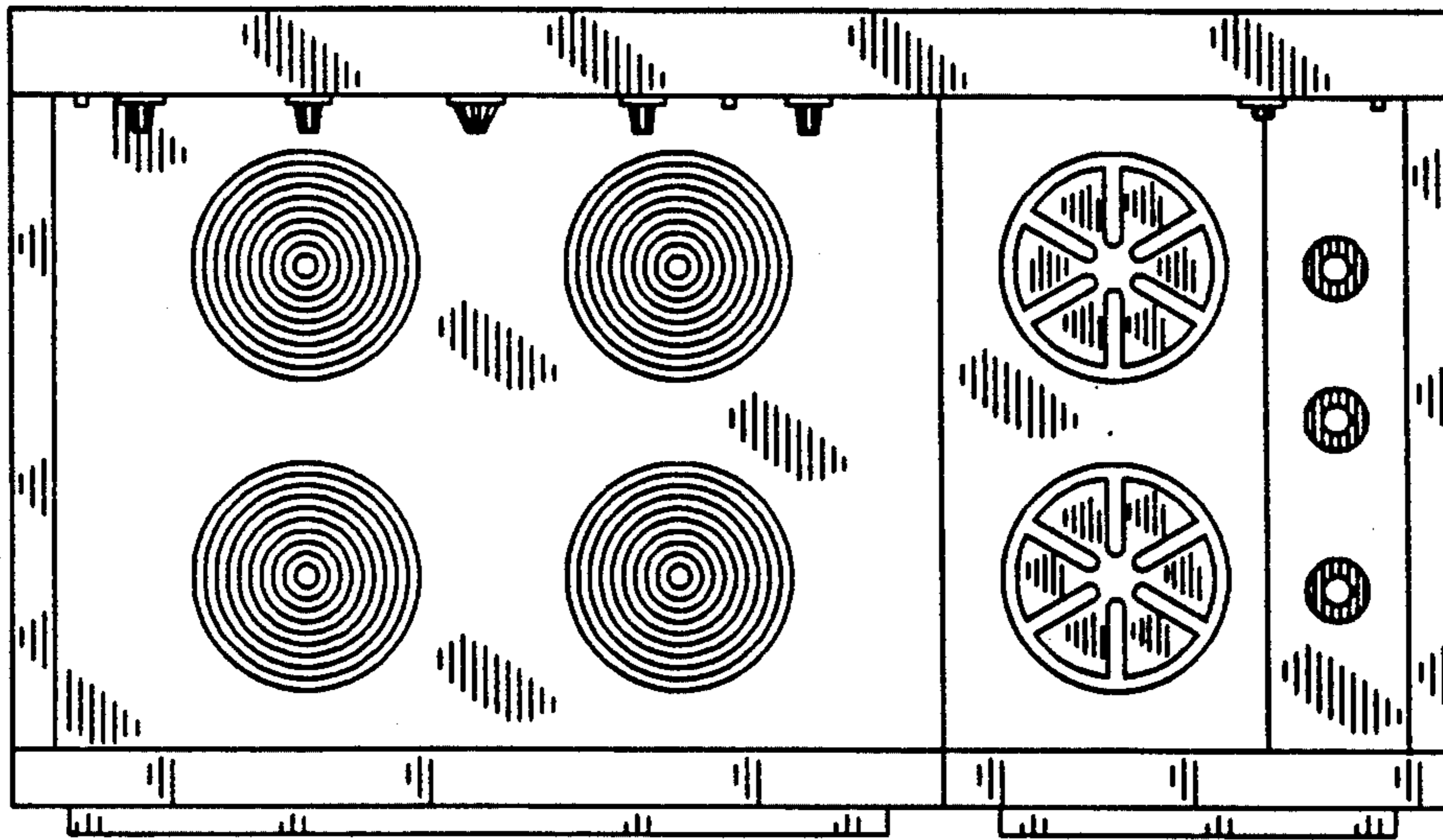

FIG. 12

