



US00D333105S

United States Patent [19]

Hayakawa

[11] Patent Number: **Des. 333,105**

[45] Date of Patent: **** Feb. 9, 1993**

[54] **CLOCK MOVEMENT**

[75] Inventor: **Tsuyoshi Hayakawa, Tokyo, Japan**

[73] Assignee: **Seikosha Co., Ltd., Japan**

[**] Term: **14 Years**

[21] Appl. No.: **305,483**

[22] Filed: **Feb. 1, 1989**

[30] **Foreign Application Priority Data**

Aug. 30, 1988 [JP] Japan 63-34250

[52] U.S. Cl. **D10/129; D10/128**

[58] Field of Search **D10/128, 129, 131; 368/76, 88, 124, 139, 155, 220, 223-226, 228, 229, 276, 300**

[56] **References Cited**

U.S. PATENT DOCUMENTS

1,044,140 11/1912 Colburn 368/220

3,049,861 8/1962 Jensen 368/300

4,912,690 3/1990 Nakamura 368/220 X

FOREIGN PATENT DOCUMENTS

0124084 9/1980 Japan 368/300

Primary Examiner—Donald P. Walsh

Assistant Examiner—Caron D. Veynar

Attorney, Agent, or Firm—Bruce L. Adams; Van C. Wilks

[57] **CLAIM**

The ornamental design for a clock movement, as shown and described.

DESCRIPTION

FIG. 1 is a front elevational view of a clock movement showing my new design;

FIG. 2 is a rear elevational view thereof;

FIG. 3 is a top plan view thereof;

FIG. 4 is a bottom plan view thereof;

FIG. 5 is a left side elevational view thereof; and,

FIG. 6 is a right side elevational view thereof.

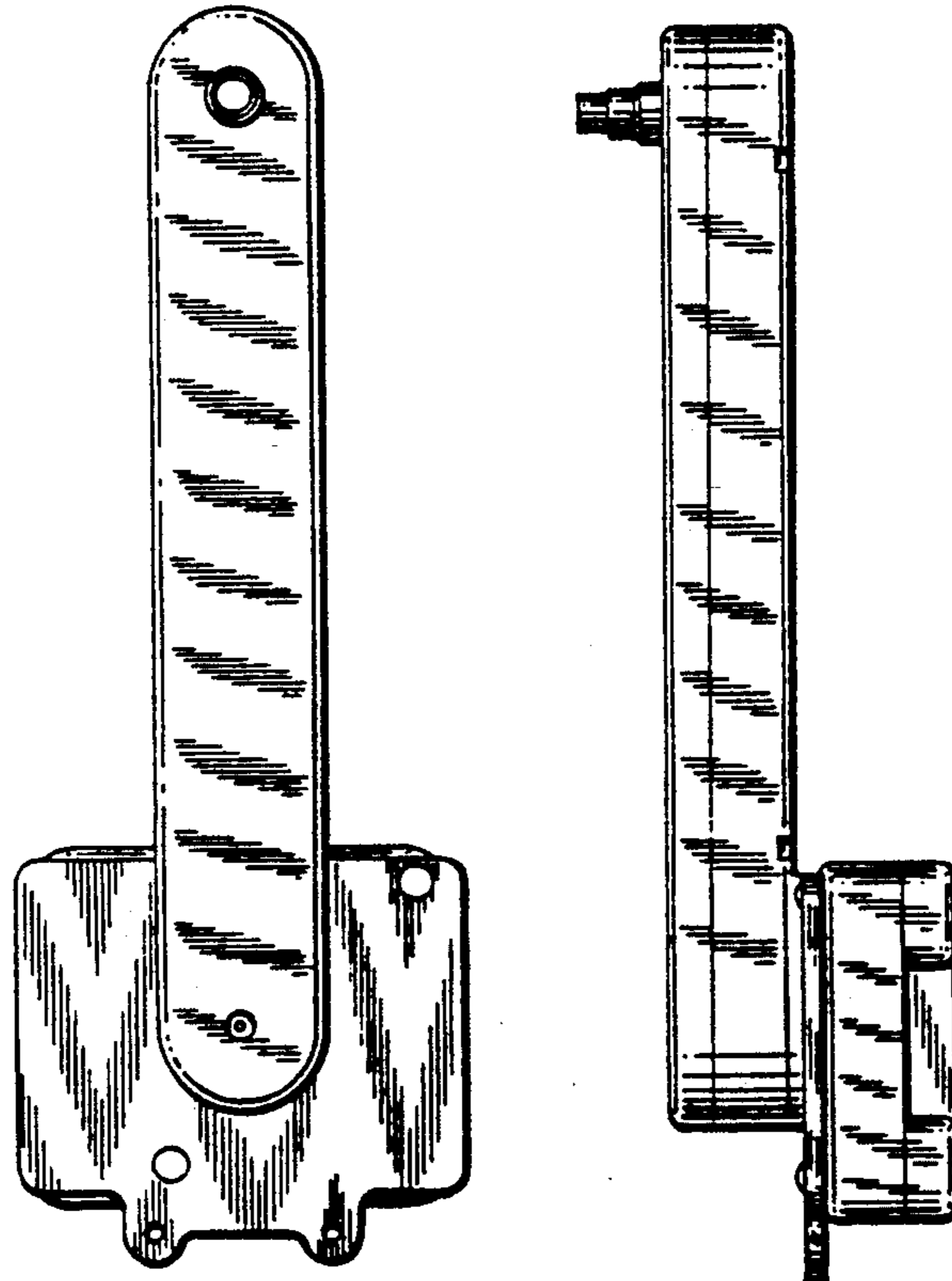

FIG. 1

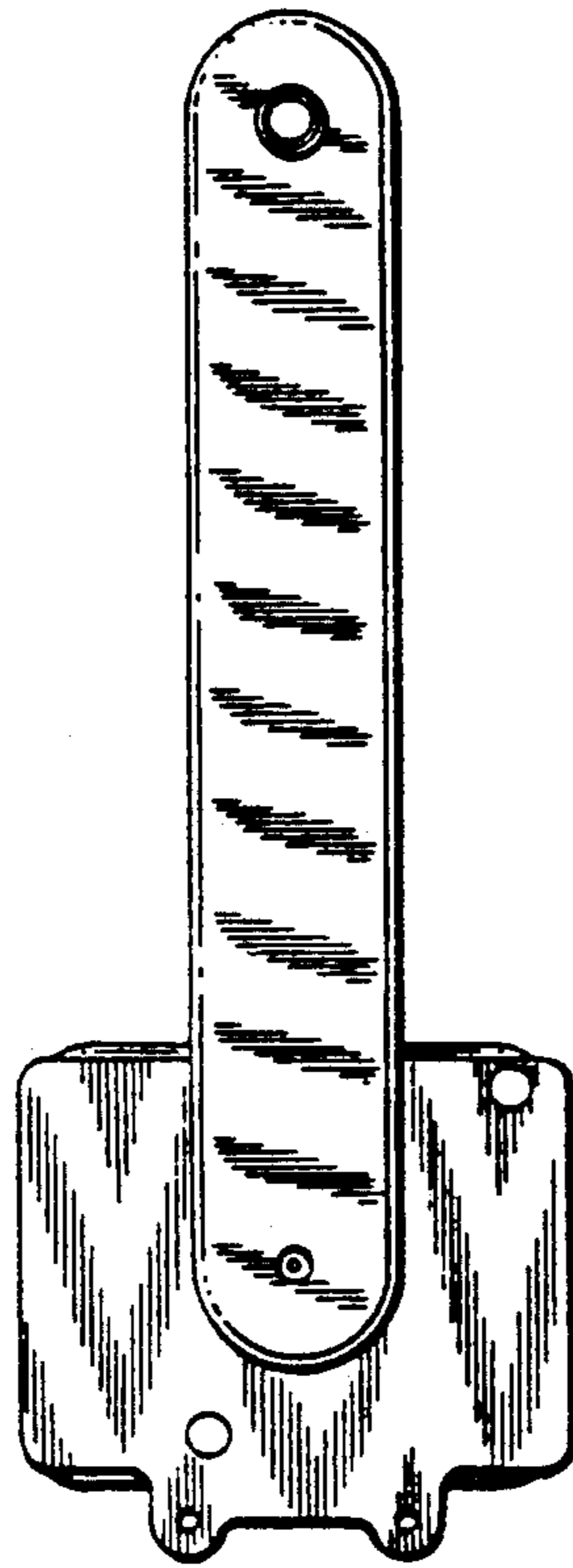

FIG. 6

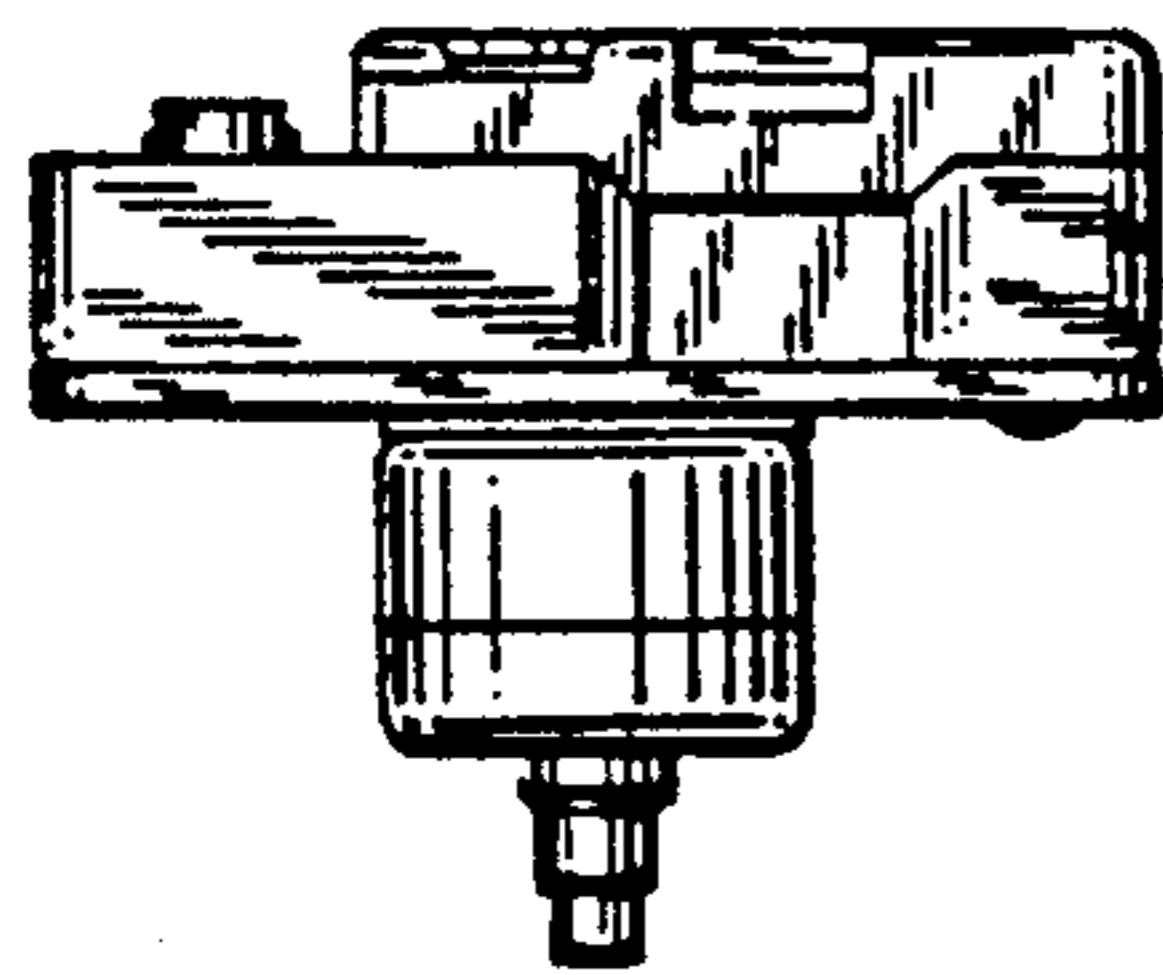
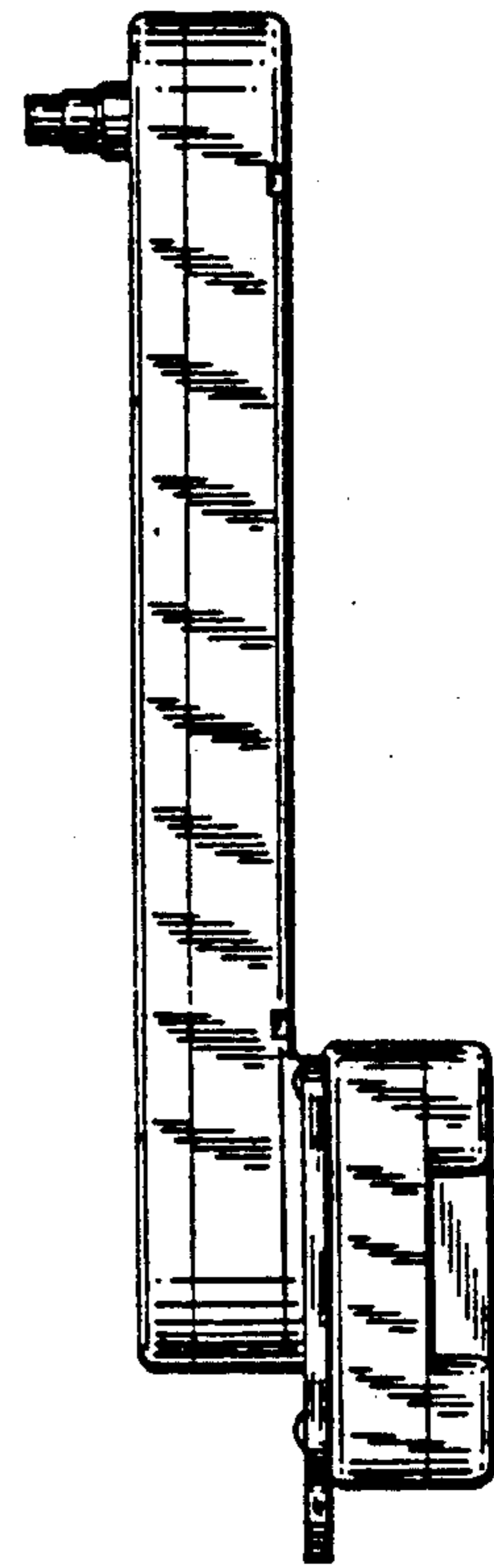

FIG. 3

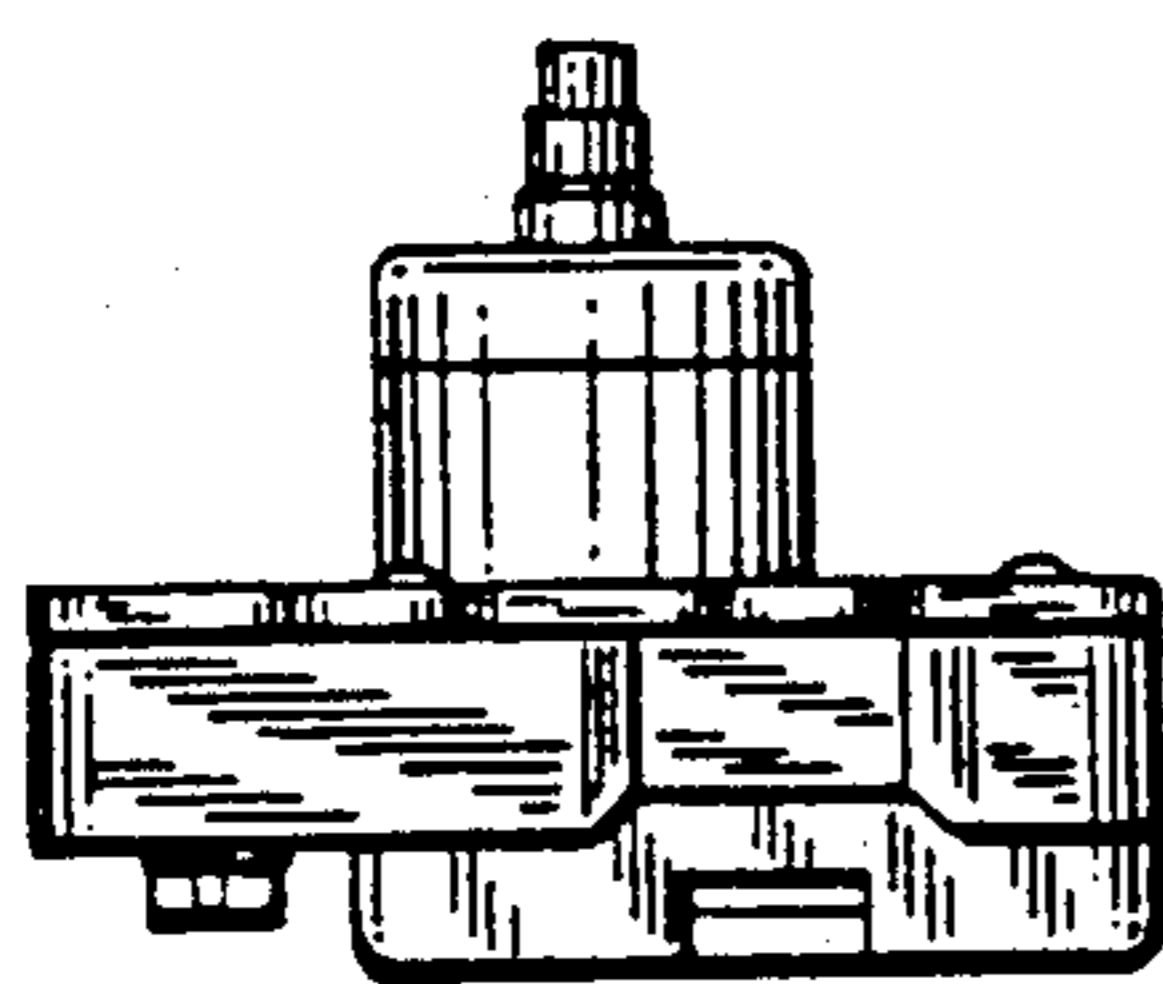

FIG. 4

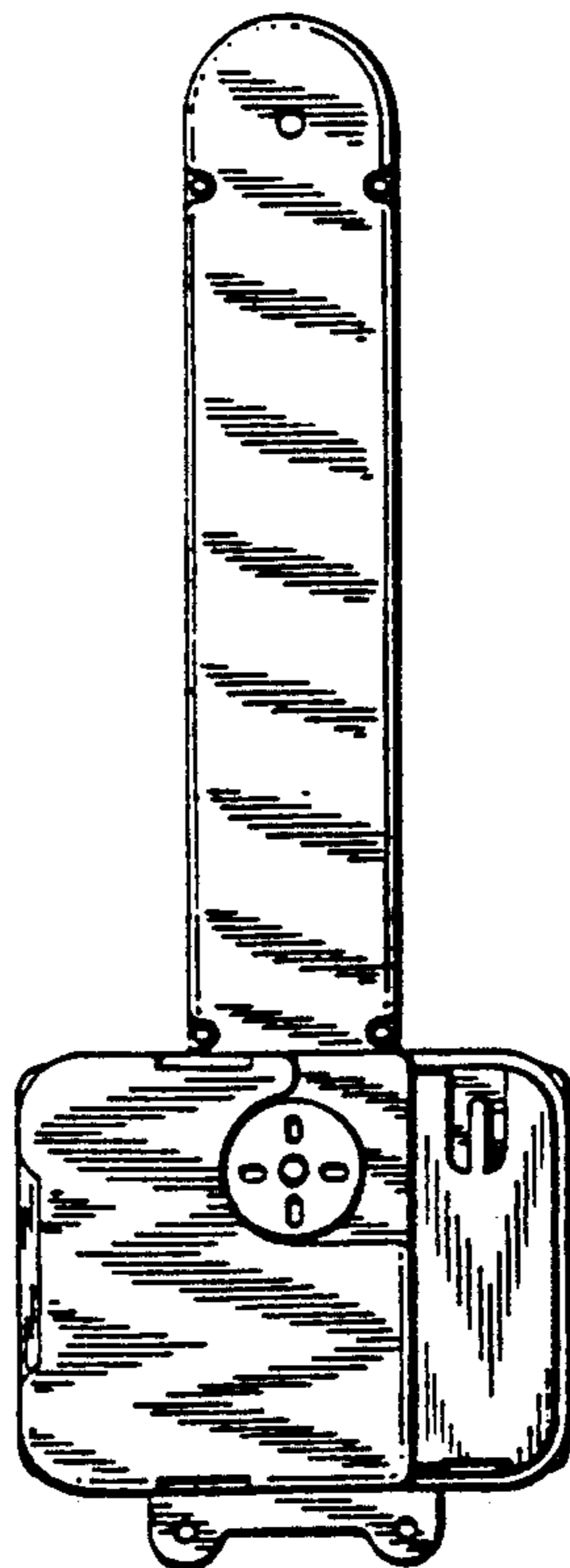

FIG. 2

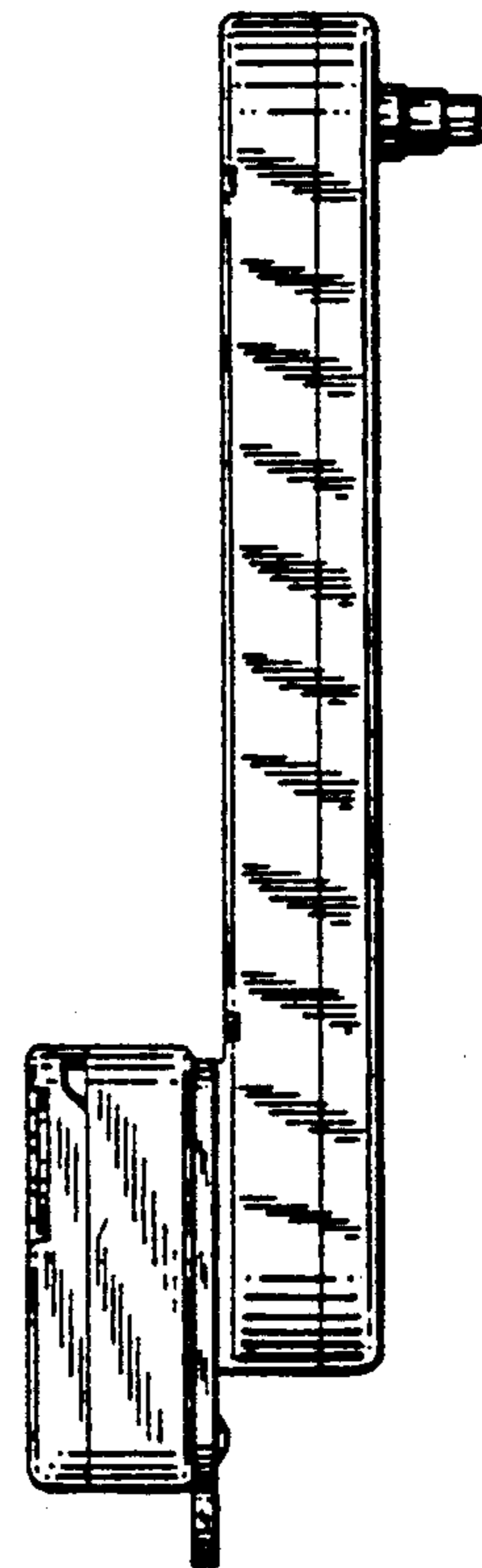

FIG. 5