



US00D333086S

United States Patent [19]

[11] Patent Number: **Des. 333,086**

Karas et al.

[45] Date of Patent: **** Feb. 9, 1993**

[54] **CEILING CLIP**

[76] Inventors: **Jeffrey Karas; Jeffrey Klein**, both of
32 Prince St., Brockton, Mass.
02402-2829

[**] Term: **14 Years**

[21] Appl. No.: **488,842**

[22] Filed: **Mar. 6, 1990**

[52] U.S. Cl. **D8/389; D8/382**

[58] Field of Search **D8/382, 383, 388, 389,
D8/390; 24/336; 248/300; 52/481, 489, 582**

[56] **References Cited**

U.S. PATENT DOCUMENTS

D. 312,772	12/1990	Paul	D8/389
D. 319,004	8/1991	Schenker	D8/382
4,000,596	1/1977	Magill et al.	52/489
4,201,025	5/1980	Williamson	52/489
4,314,433	2/1982	Hulcombe	D8/382
4,333,286	6/1982	Weinar	52/489
4,599,831	7/1986	Magaha, Jr.	52/489
4,831,808	5/1989	Wynar	D8/390

FOREIGN PATENT DOCUMENTS

0064938	6/1942	Norway	248/300
1079103	8/1967	United Kingdom	24/336

Primary Examiner—Bernard Ansher
Assistant Examiner—Sandra Morris

[57] **CLAIM**

The ornamental design for a ceiling clip, as shown and described.

DESCRIPTION

FIG. 1 is a perspective view of a ceiling clip showing our new design;
FIG. 2 is a right side elevational view thereof, the left side being identical;
FIG. 3 is a rear elevational view thereof;
FIG. 4 is a front elevational view thereof;
FIG. 5 is a top plan view thereof;
FIG. 6 is a bottom plan view thereof; and,
FIG. 7 is a reduced perspective view thereof, the ceiling element shown in broken lines is for illustrative purposes only, and forms no part of the claimed design.

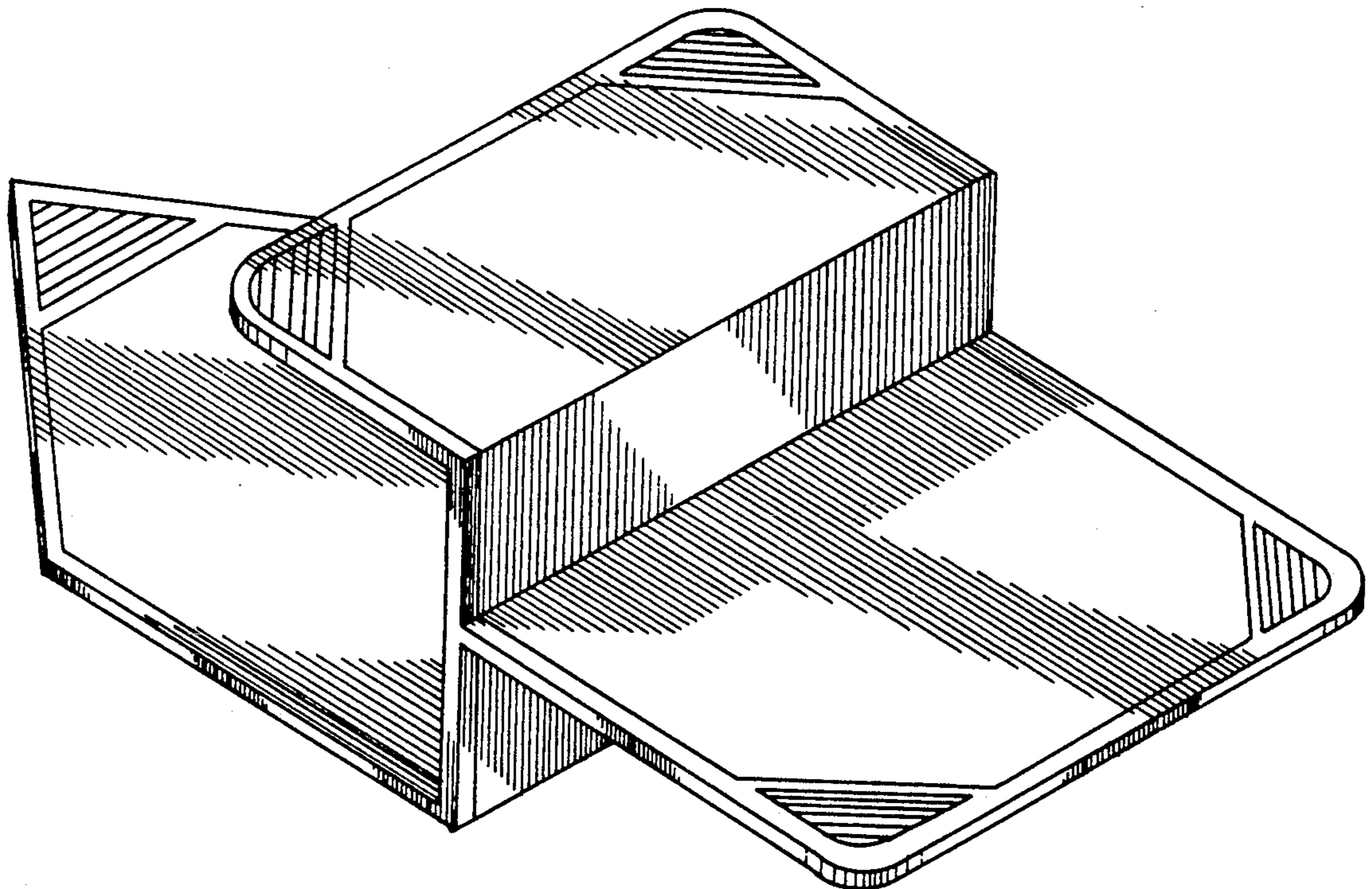

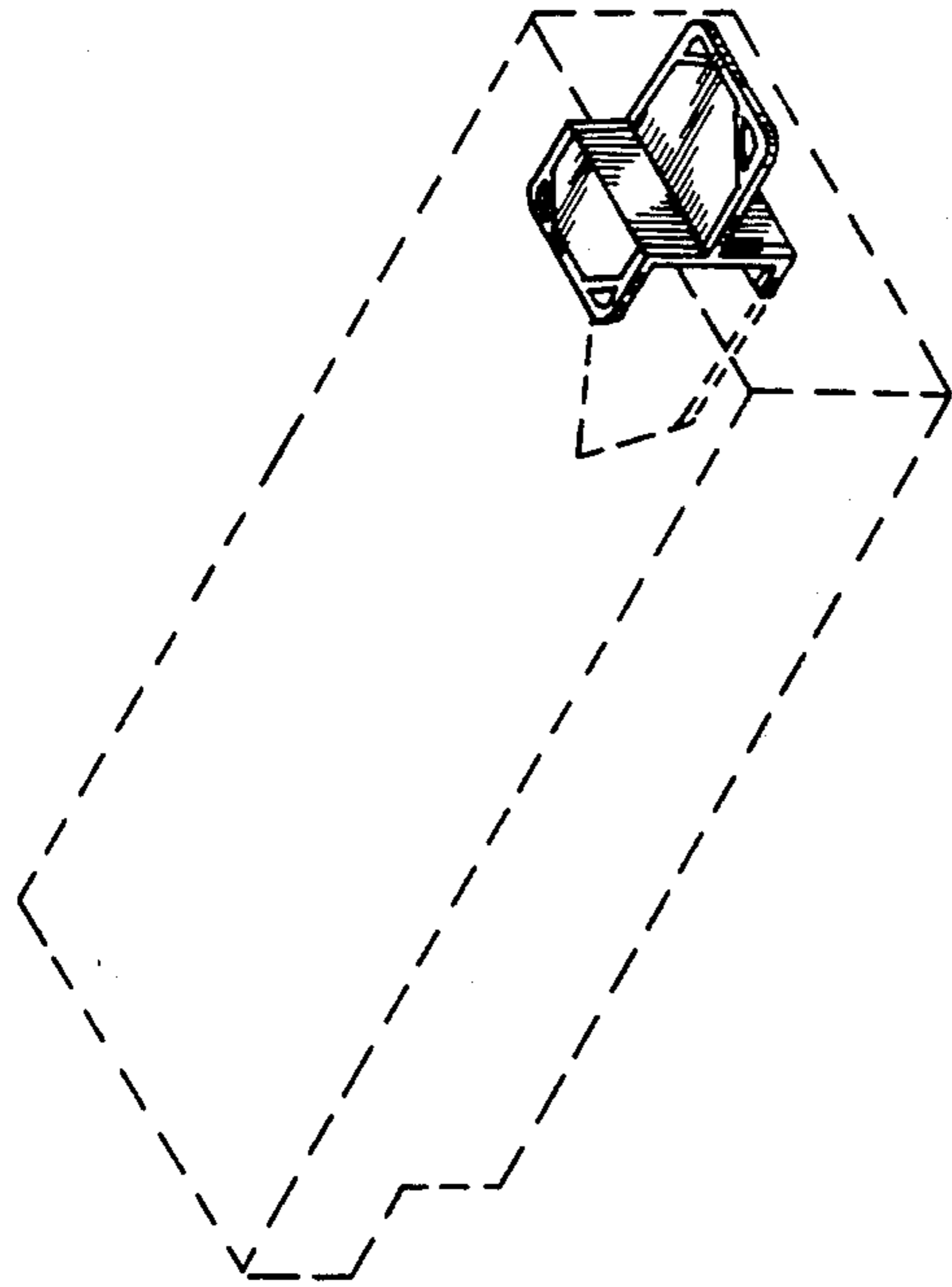

FIG. 7.

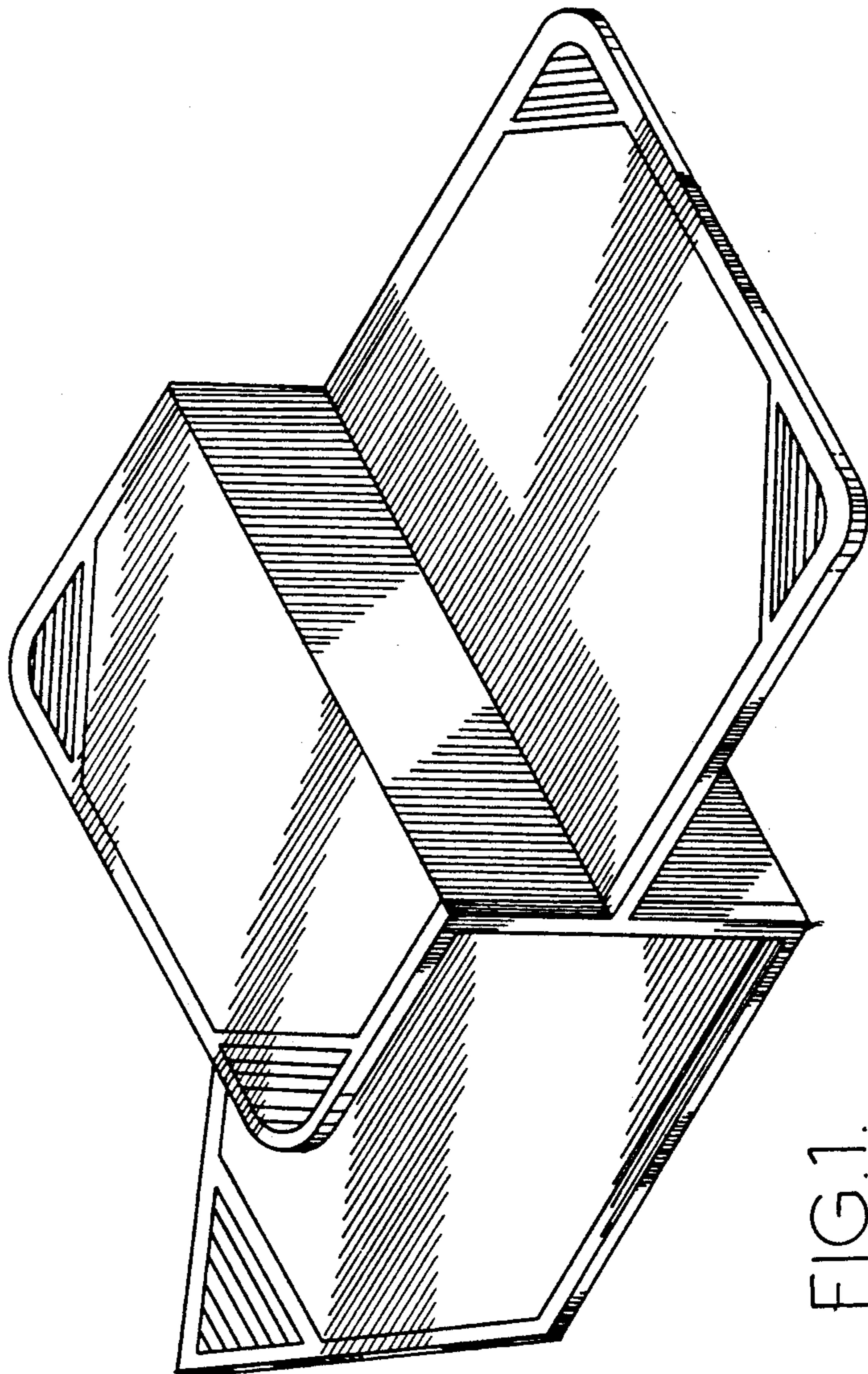

FIG. 1.

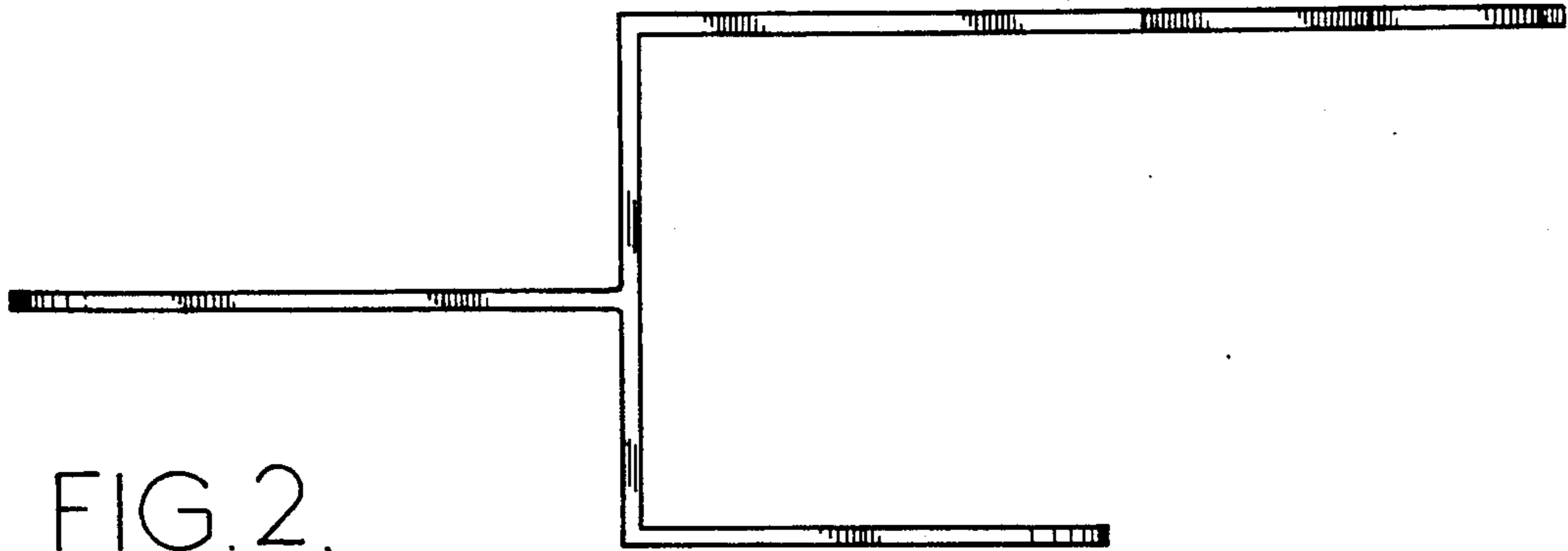

FIG. 2.

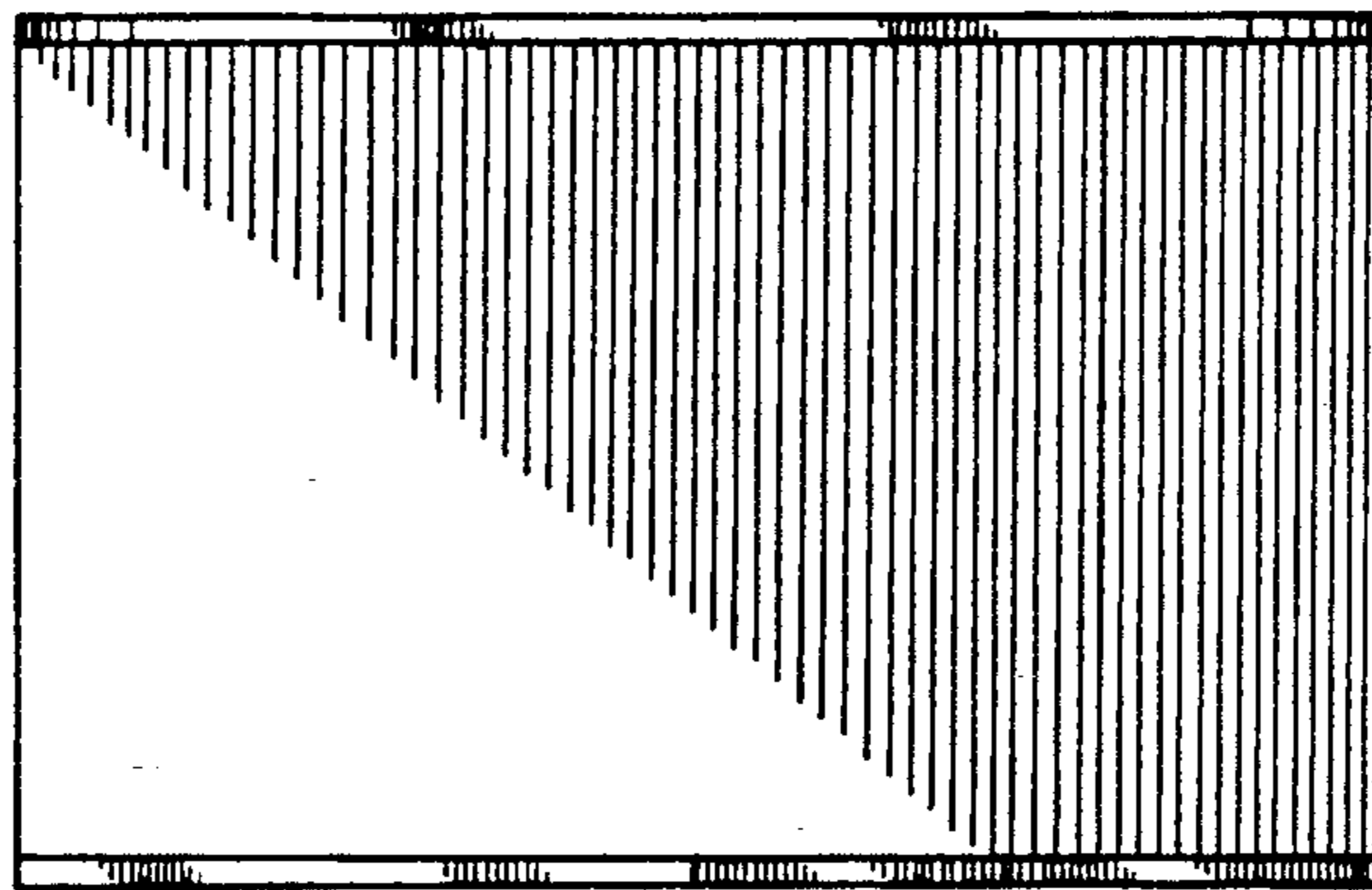

FIG. 4.

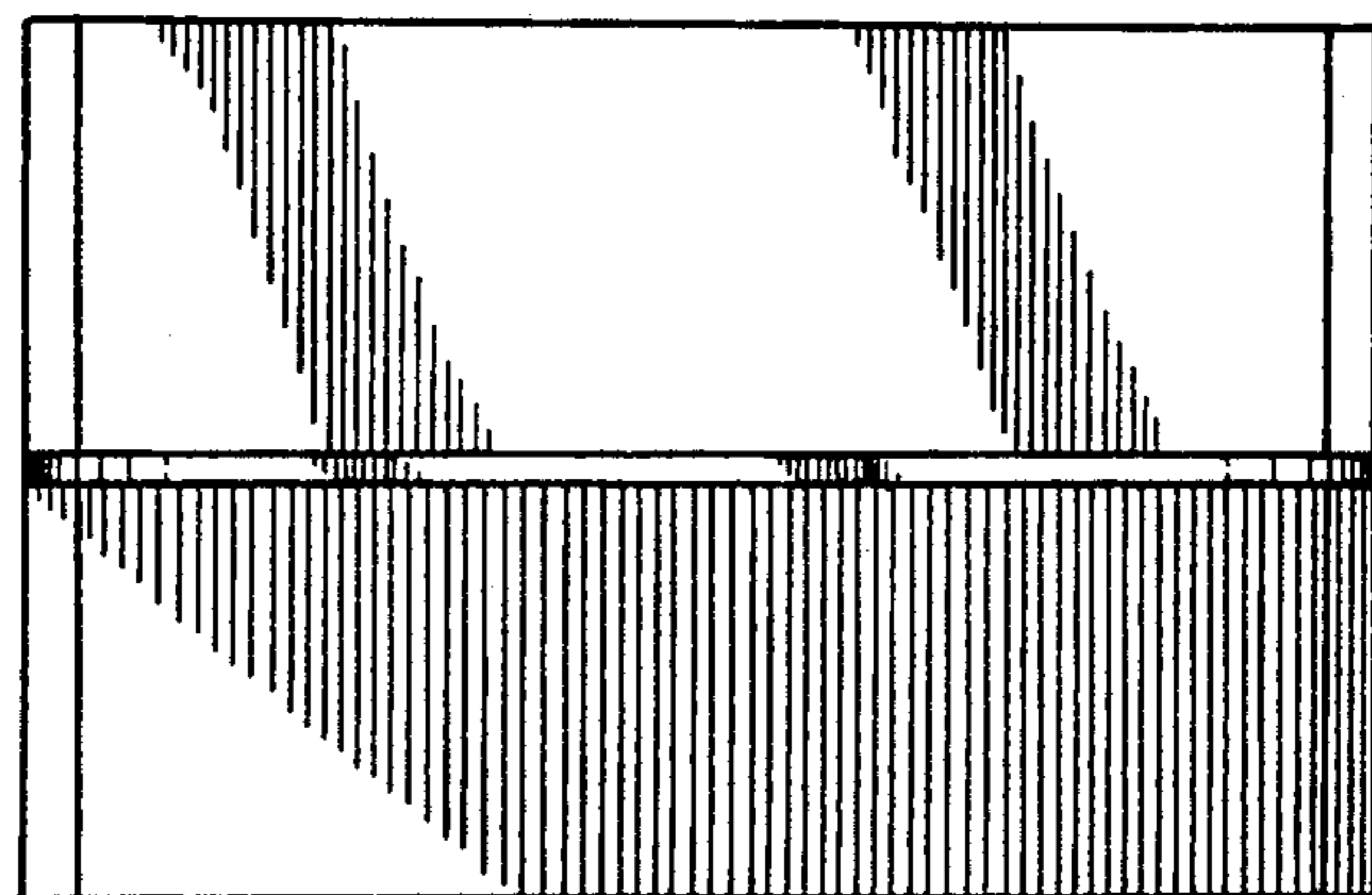

FIG. 3.

FIG. 6.

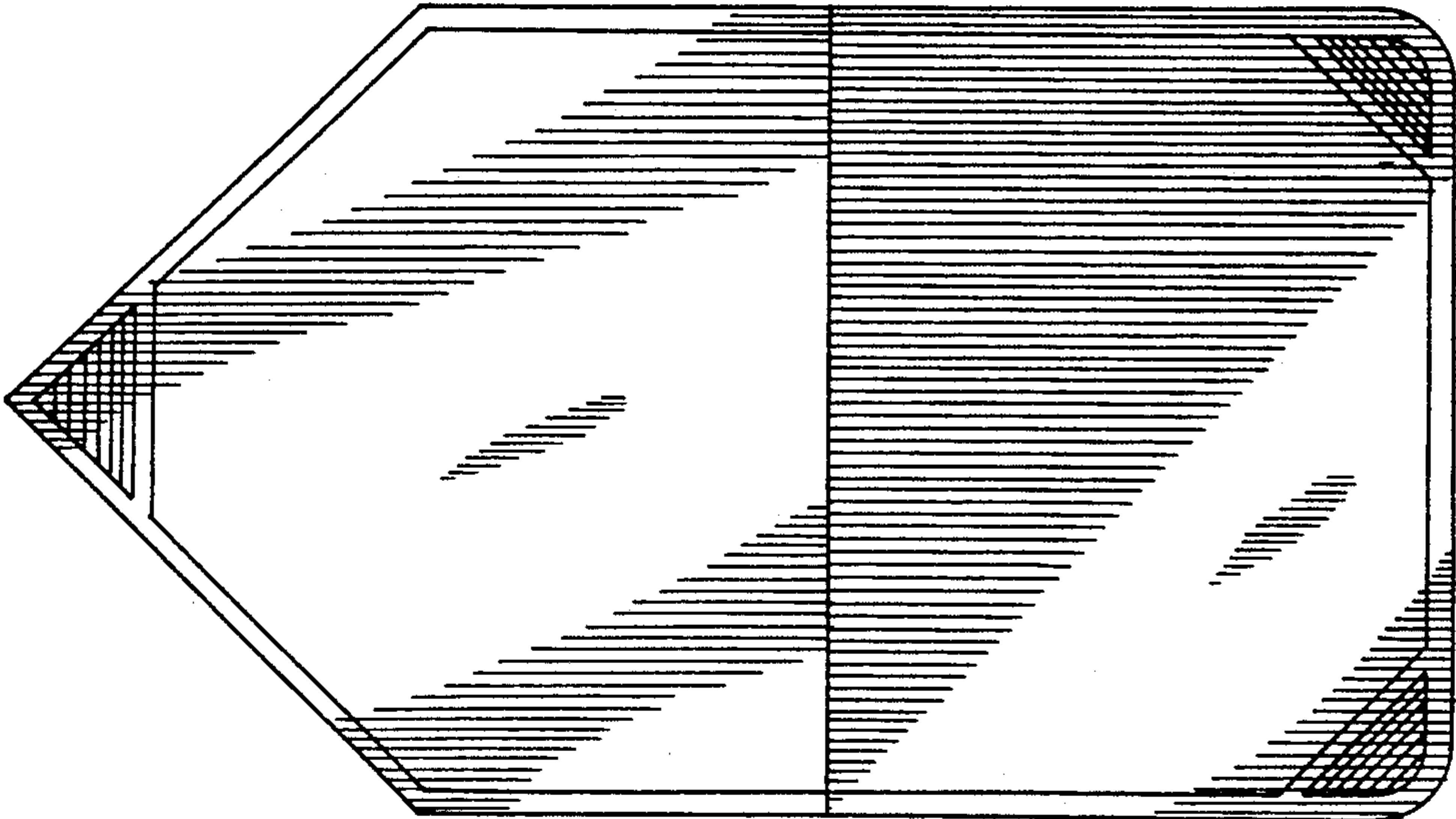

FIG. 5.

