



US00D333063S

United States Patent [19]

[11] Patent Number: **Des. 333,063**

Podesta Burke

[45] Date of Patent: **** Feb. 9, 1993**

[54] SHOWER DISPENSER FOR SHAMPOO

DESCRIPTION

- [76] Inventor: **Sally J. Podesta Burke, 2518 Sheridan Way, Stockton, Calif. 95207**
- [**] Term: **14 Years**
- [21] Appl. No.: **652,748**
- [22] Filed: **Feb. 8, 1991**
- [52] U.S. Cl. **D6/545; D6/544**
- [58] Field of Search **D6/542-545; 221/45, 96, 282-286; 222/154, 156, 159, 173, 180-181, 185**

FIG. 1 is a top, front, and left side perspective view of a shower dispenser for shampoo showing my new design;
 FIG. 2 is a bottom, front, and left side perspective view thereof;
 FIG. 3 is a front elevational view thereof;
 FIG. 4 is a left side elevational view thereof, the right side being a mirror image of that shown, except for the knob element;
 FIG. 5 is a rear elevational view thereof;
 FIG. 6 is a top plan view thereof;
 FIG. 7 is a bottom plan view thereof;
 FIG. 8 is a top, front, and left side perspective view of an alternate embodiment of a shower dispenser for shampoo showing my new design;
 FIG. 9 is a bottom, front, and left side perspective view thereof;
 FIG. 10 is a front elevational view thereof;
 FIG. 11 is a left side elevational view thereof, the right side being a mirror image of that shown, except for the knob element;
 FIG. 12 is a rear elevational view thereof;
 FIG. 13 is a top plan view thereof;
 FIG. 14 is a bottom plan view thereof; and,
 FIG. 15 is a left side elevational view thereof, shown in an alternate position, with the broken-line disclosure of the container being for illustrative purposes only and forming no part of the claimed design.

[56] References Cited

U.S. PATENT DOCUMENTS

D. 210,567	3/1968	Stanziale	D6/545
D. 217,872	6/1970	Sessions	D6/545
D. 297,086	8/1988	Paphis	D6/544
D. 321,453	11/1991	Ophardt	D6/542 X
D. 324,619	3/1992	Comstock et al.	D6/544
2,760,688	8/1956	Packwood	222/181
2,965,267	12/1960	Darr	222/181 X

Primary Examiner—Brian N. Vinson
 Attorney, Agent, or Firm—Lothrop & West

[57] CLAIM

The ornamental design for a shower dispenser for shampoo, as shown and described.

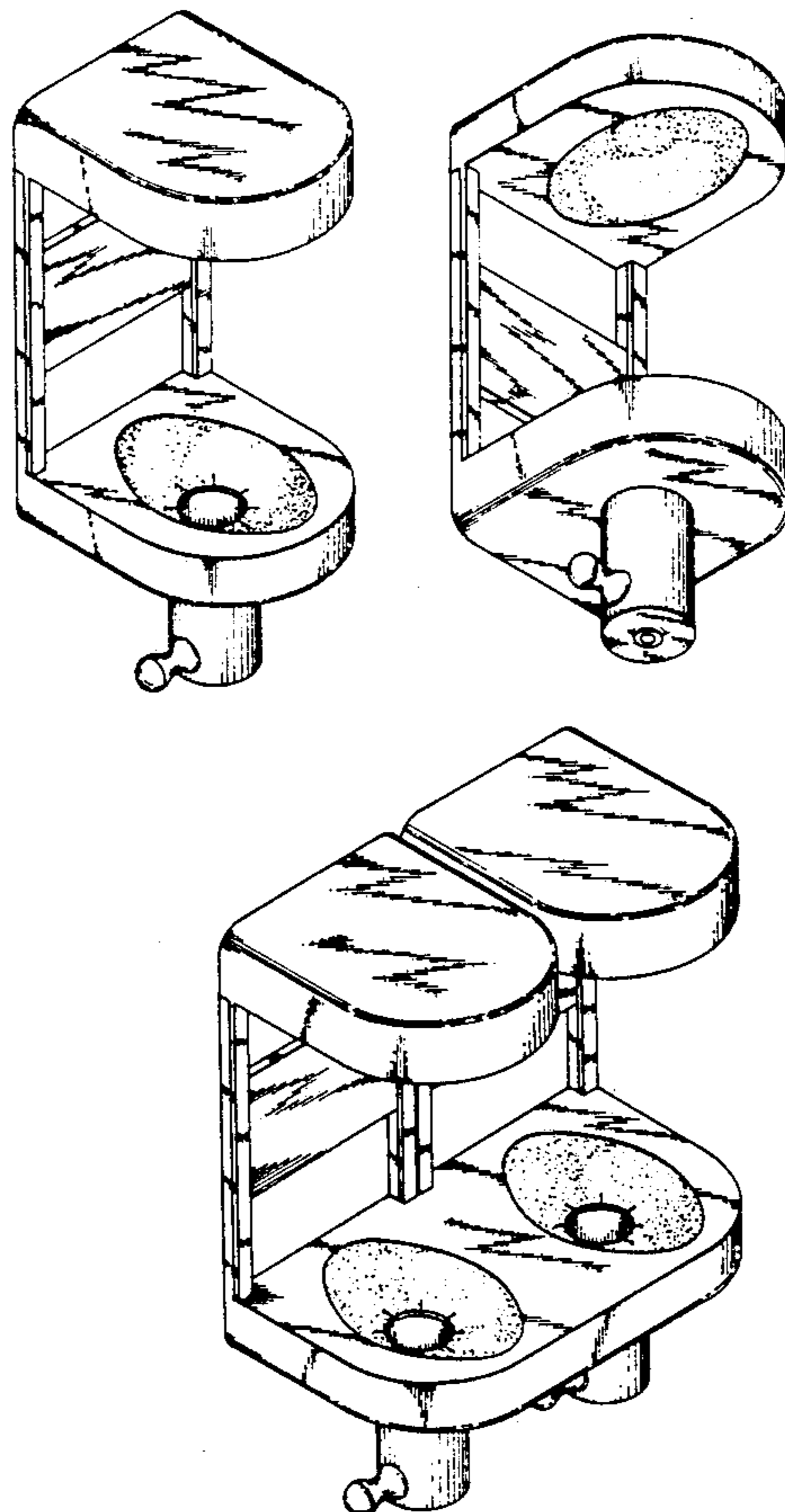

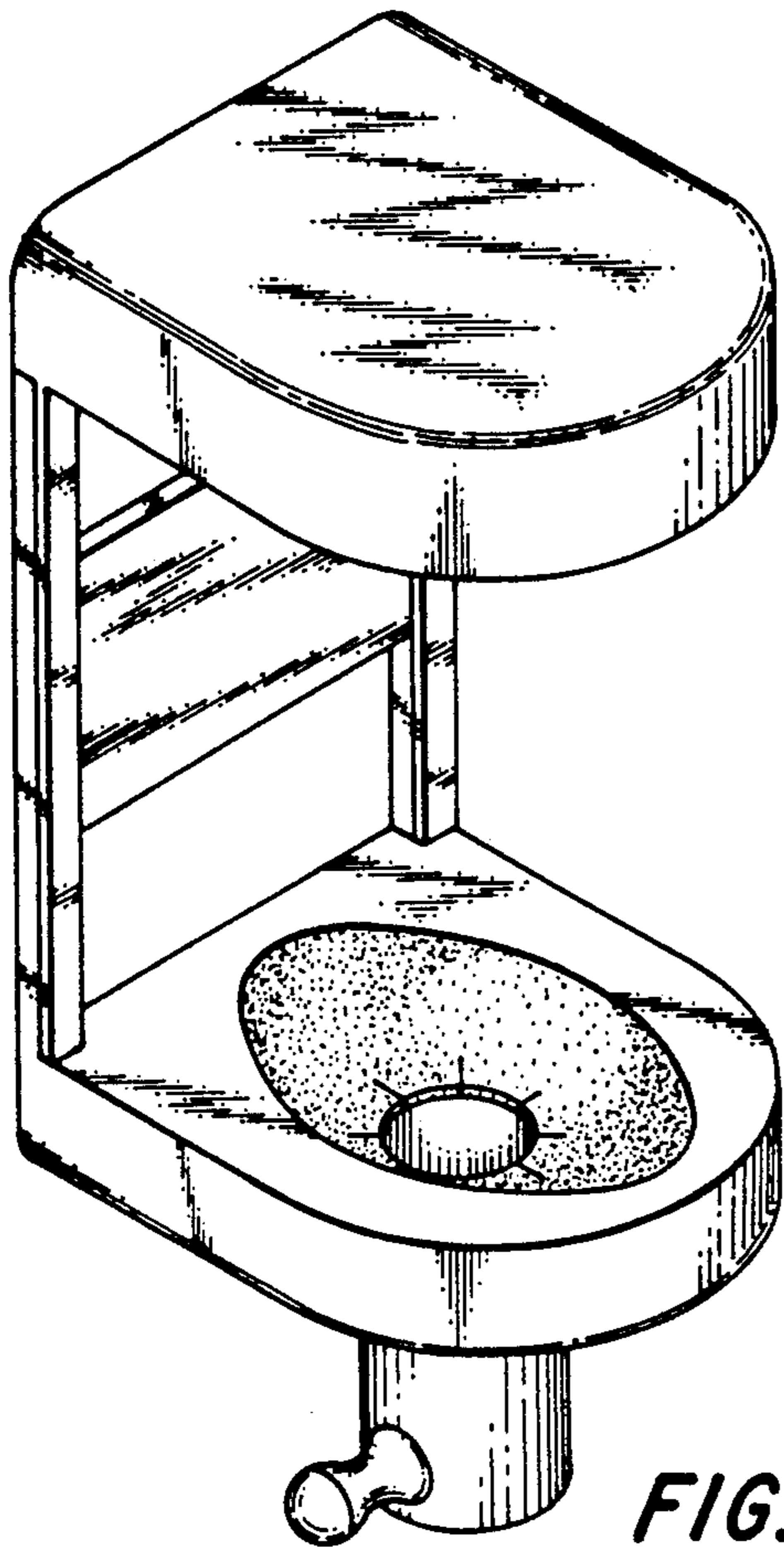

FIG. 1.

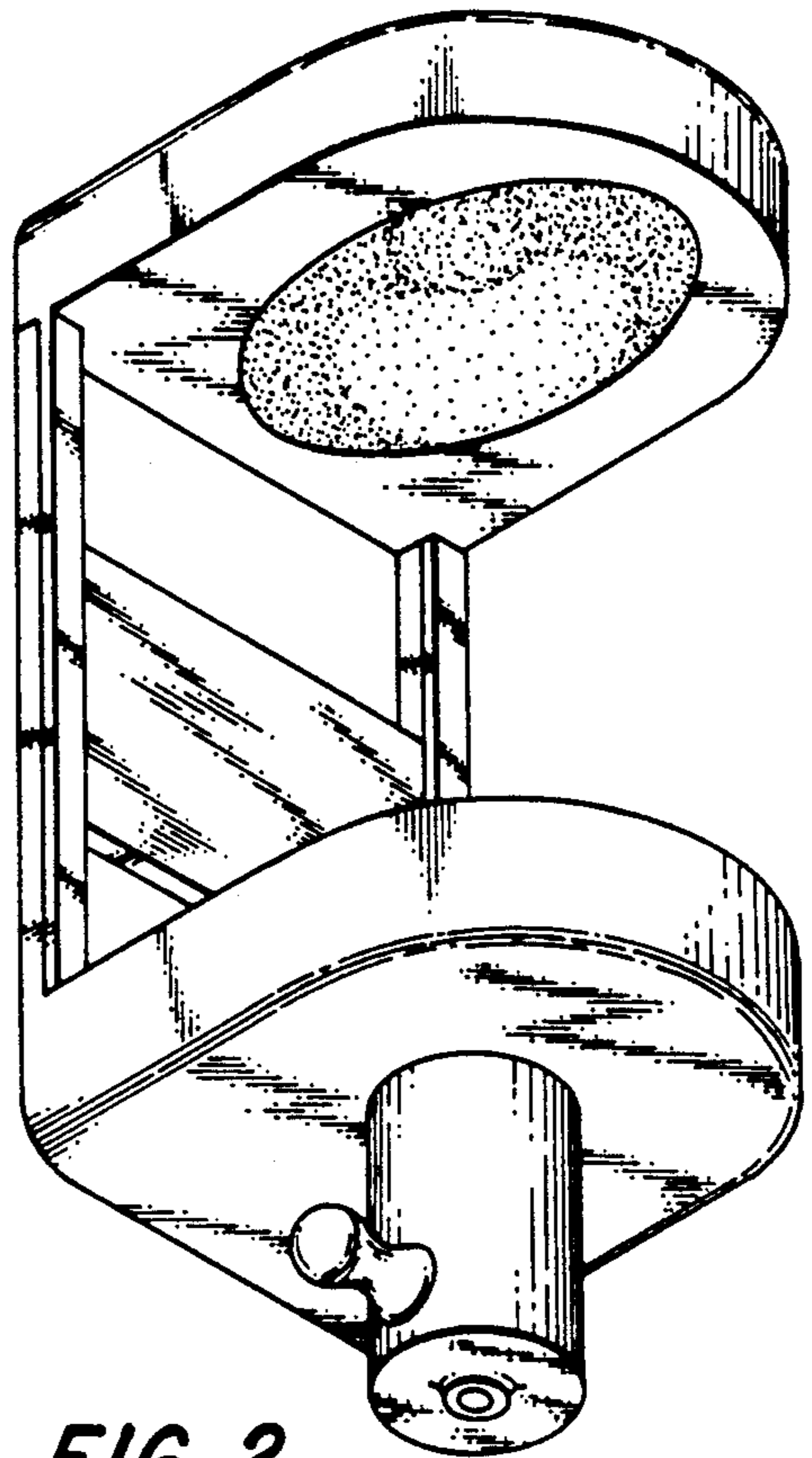

FIG. 2.

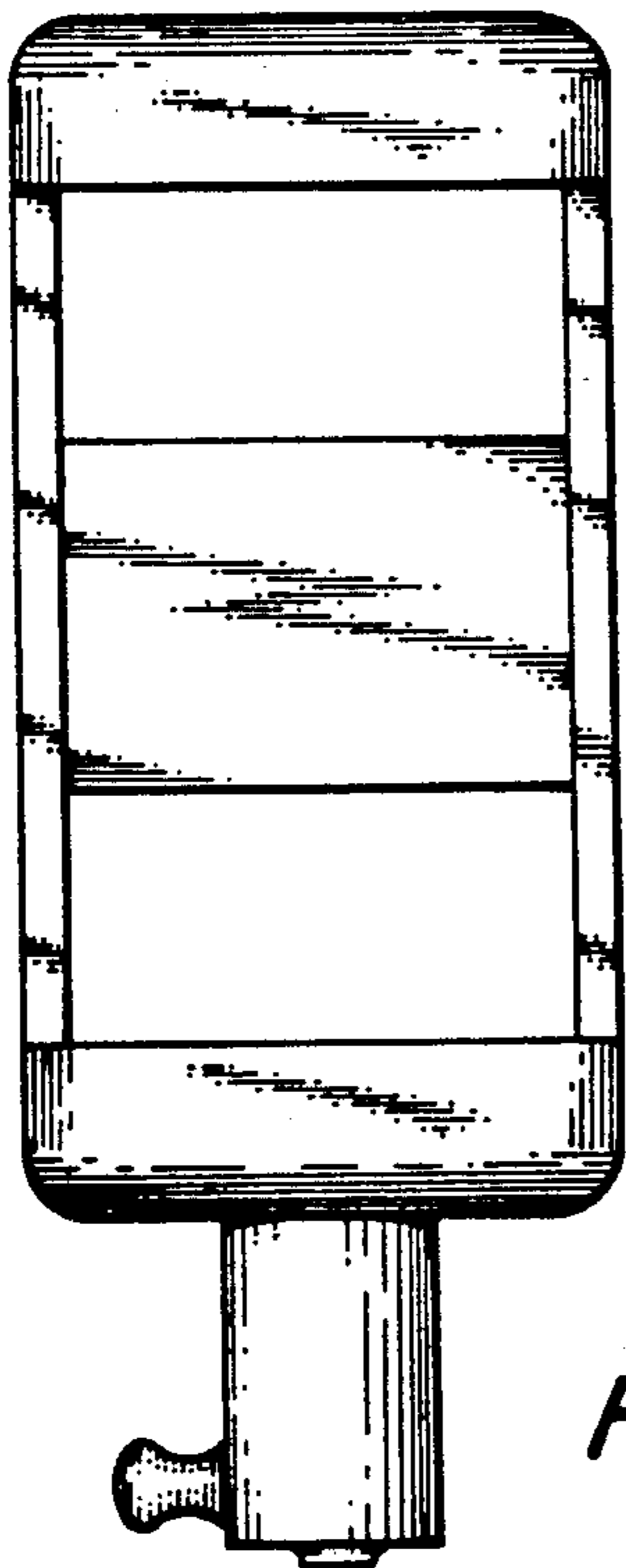

FIG. 3.

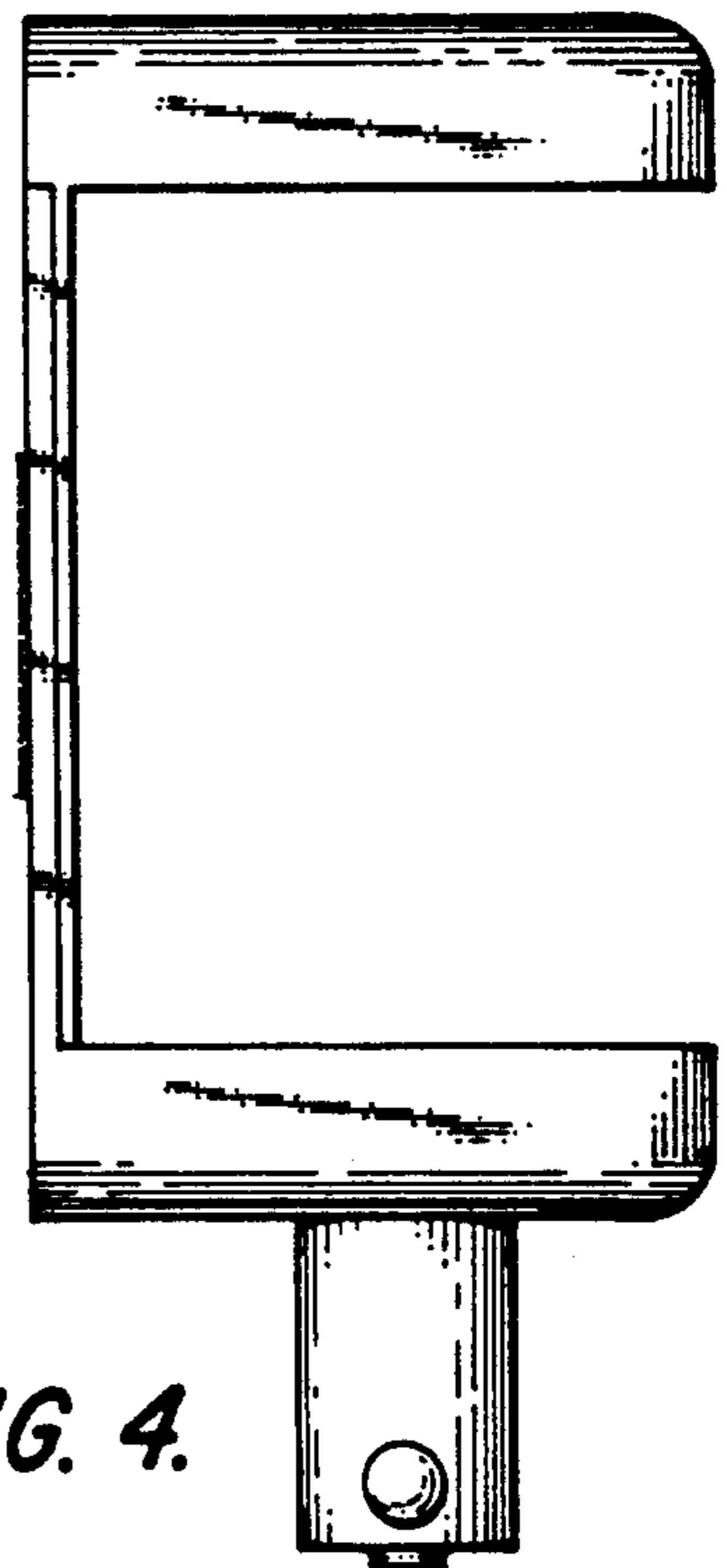

FIG. 4.

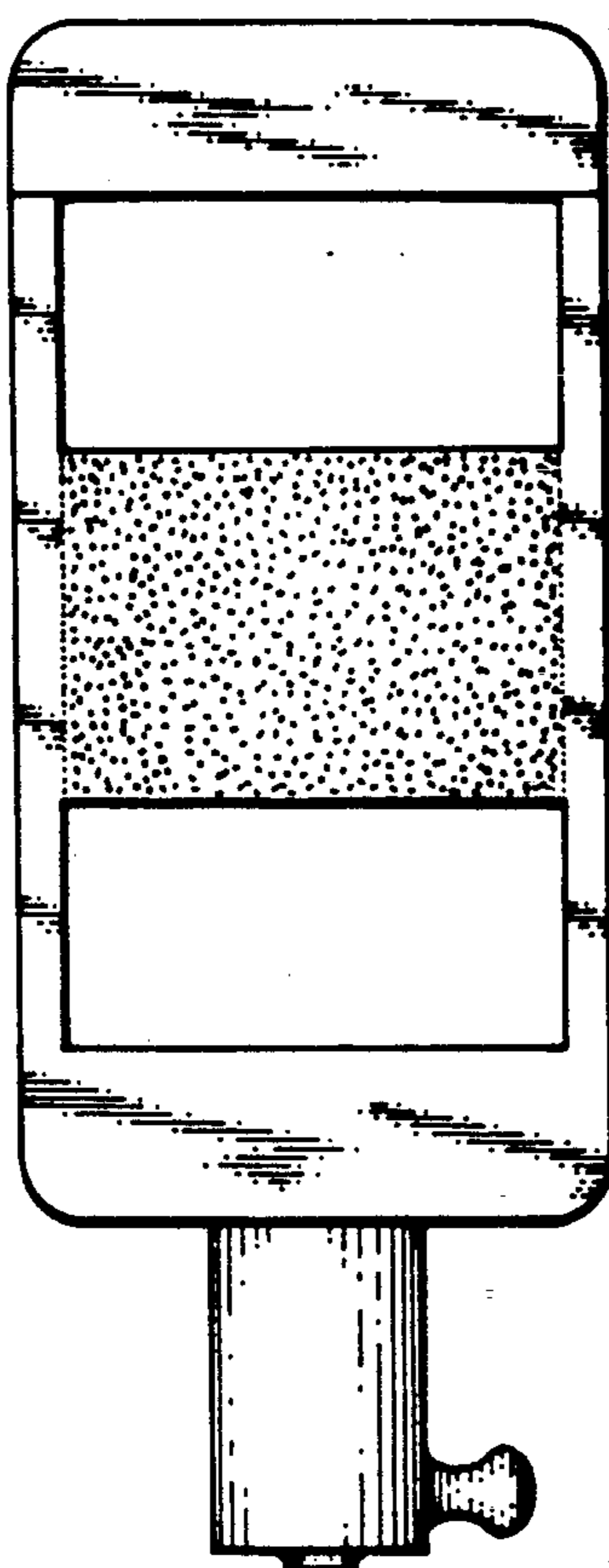

FIG. 5.

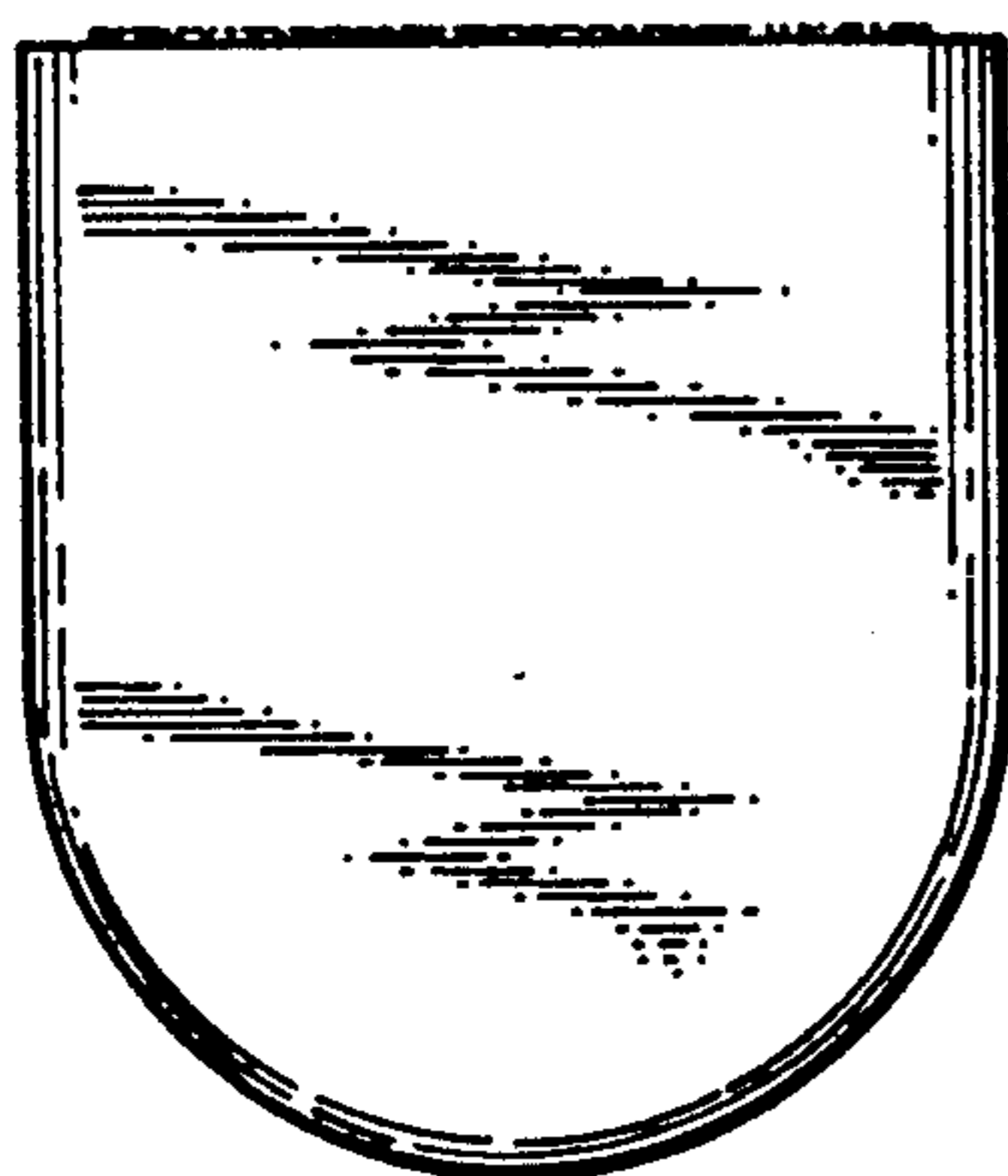

FIG. 6.

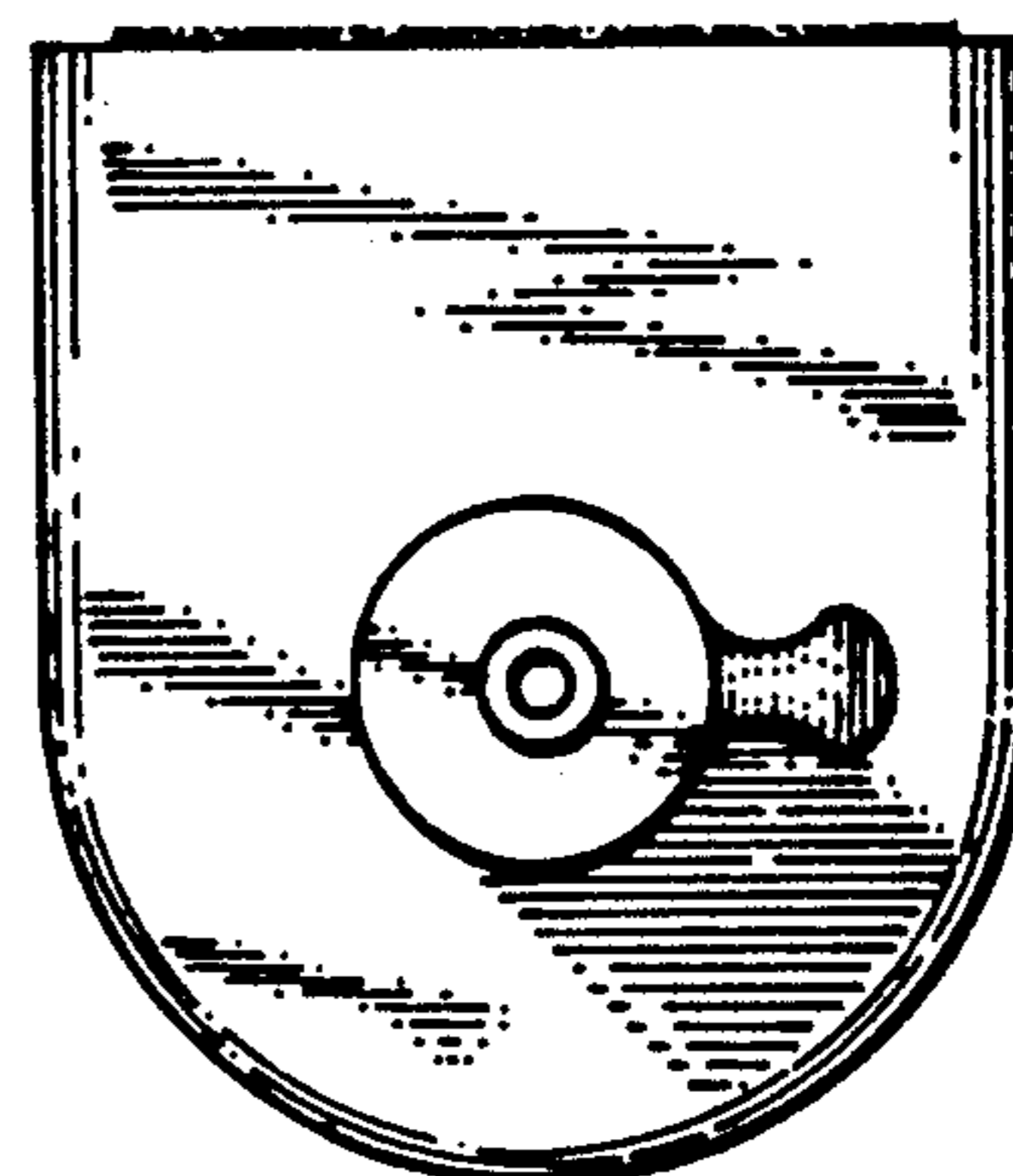

FIG. 7.

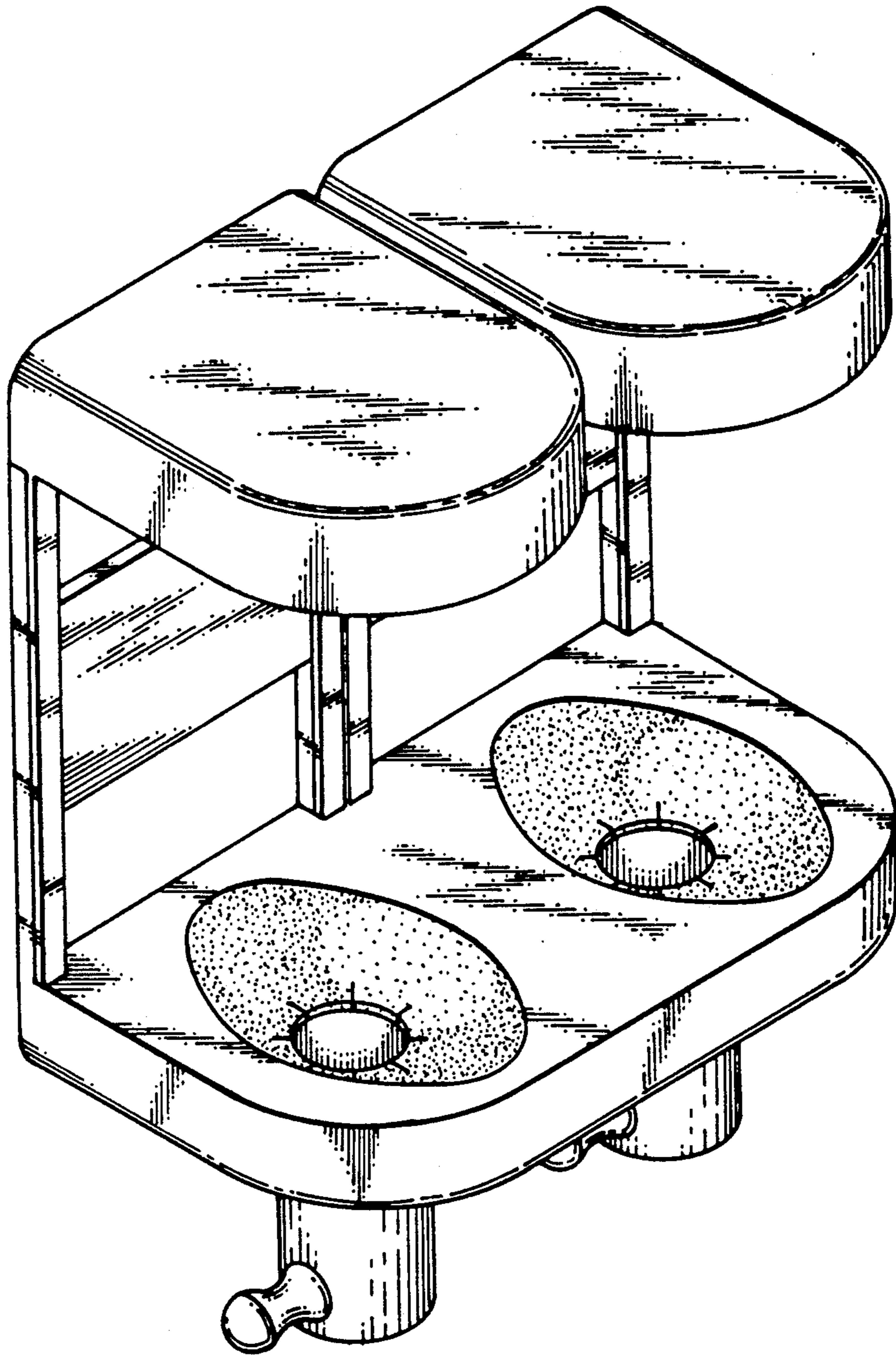

FIG. 8.

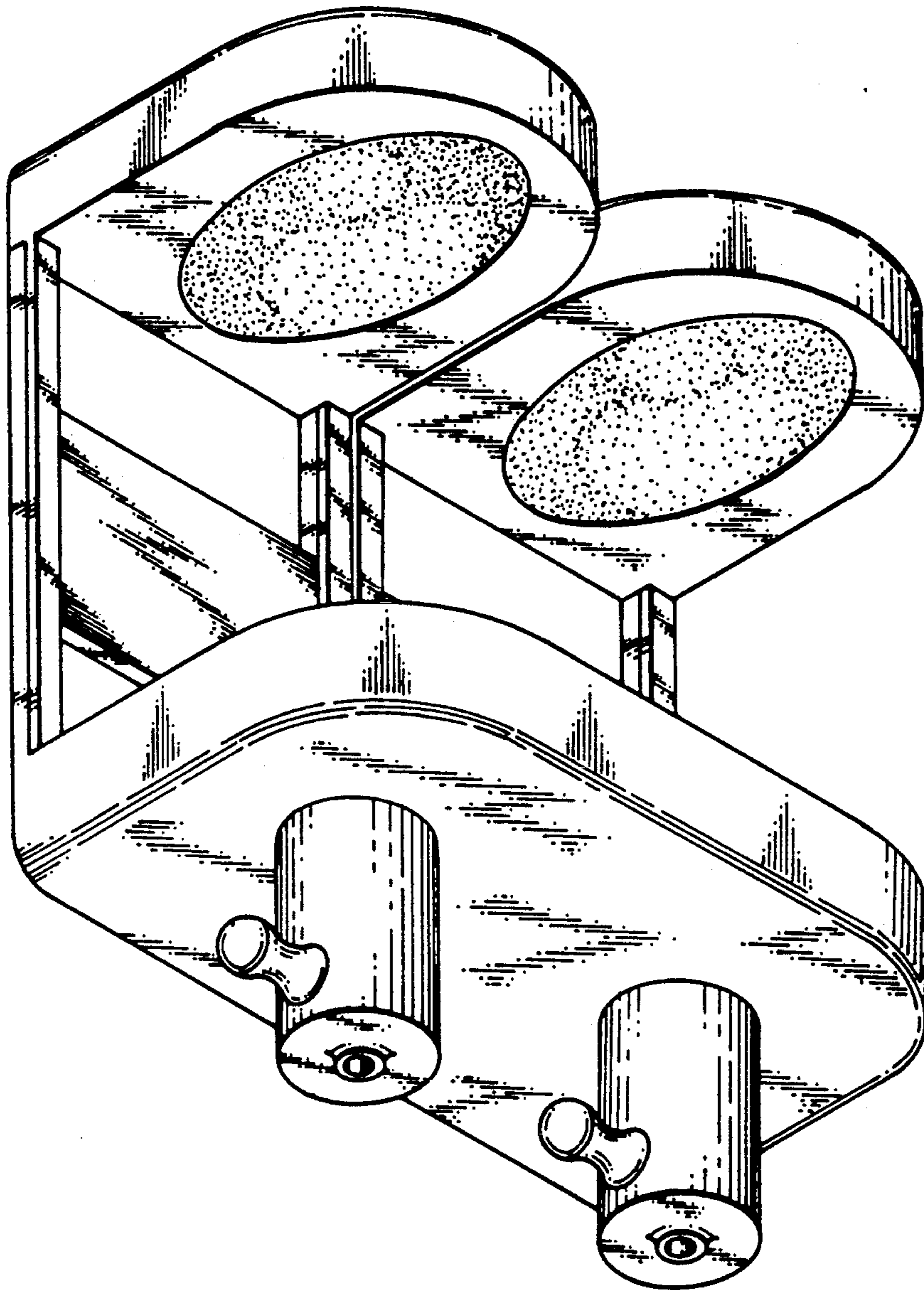

FIG. 9.

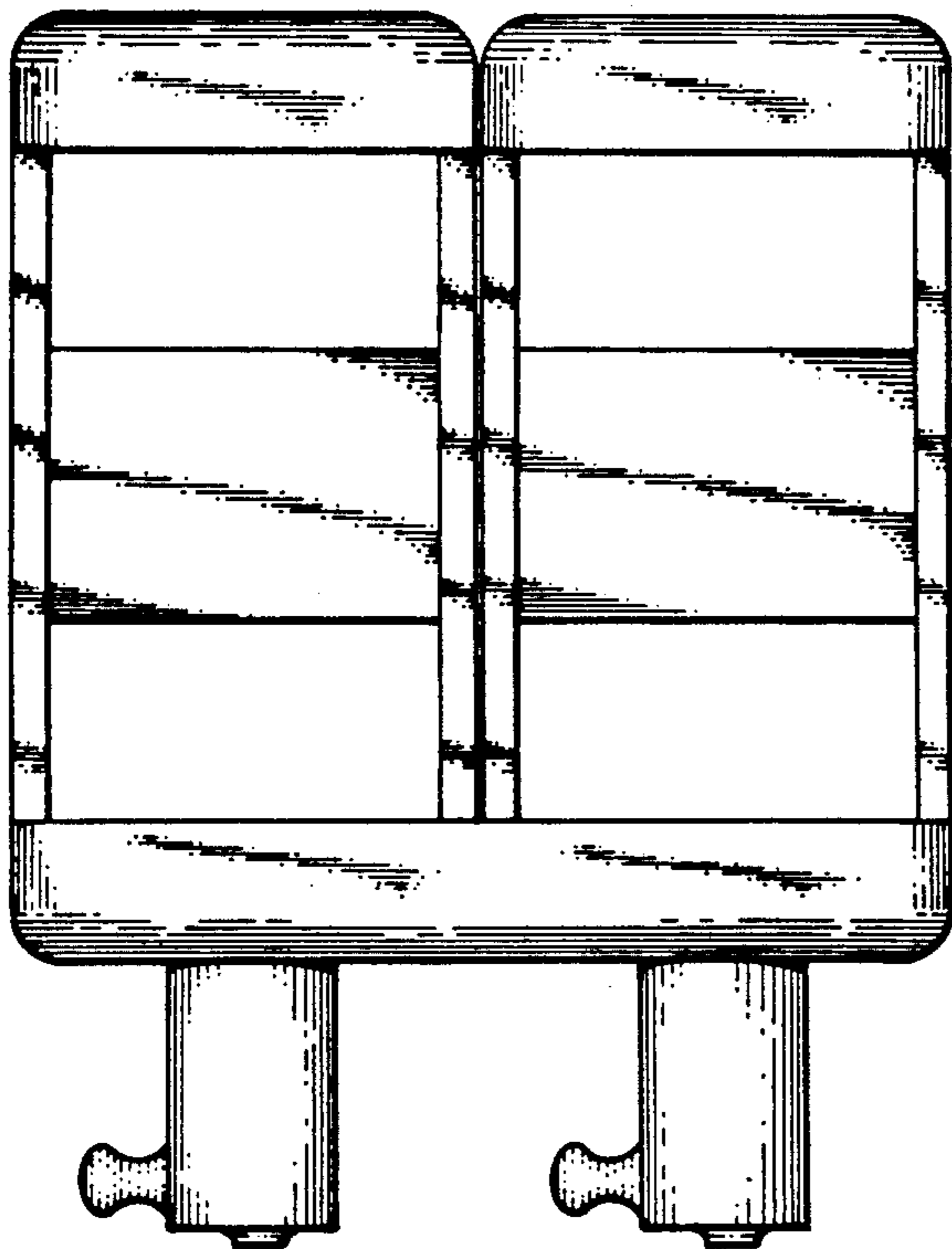

FIG. 10.

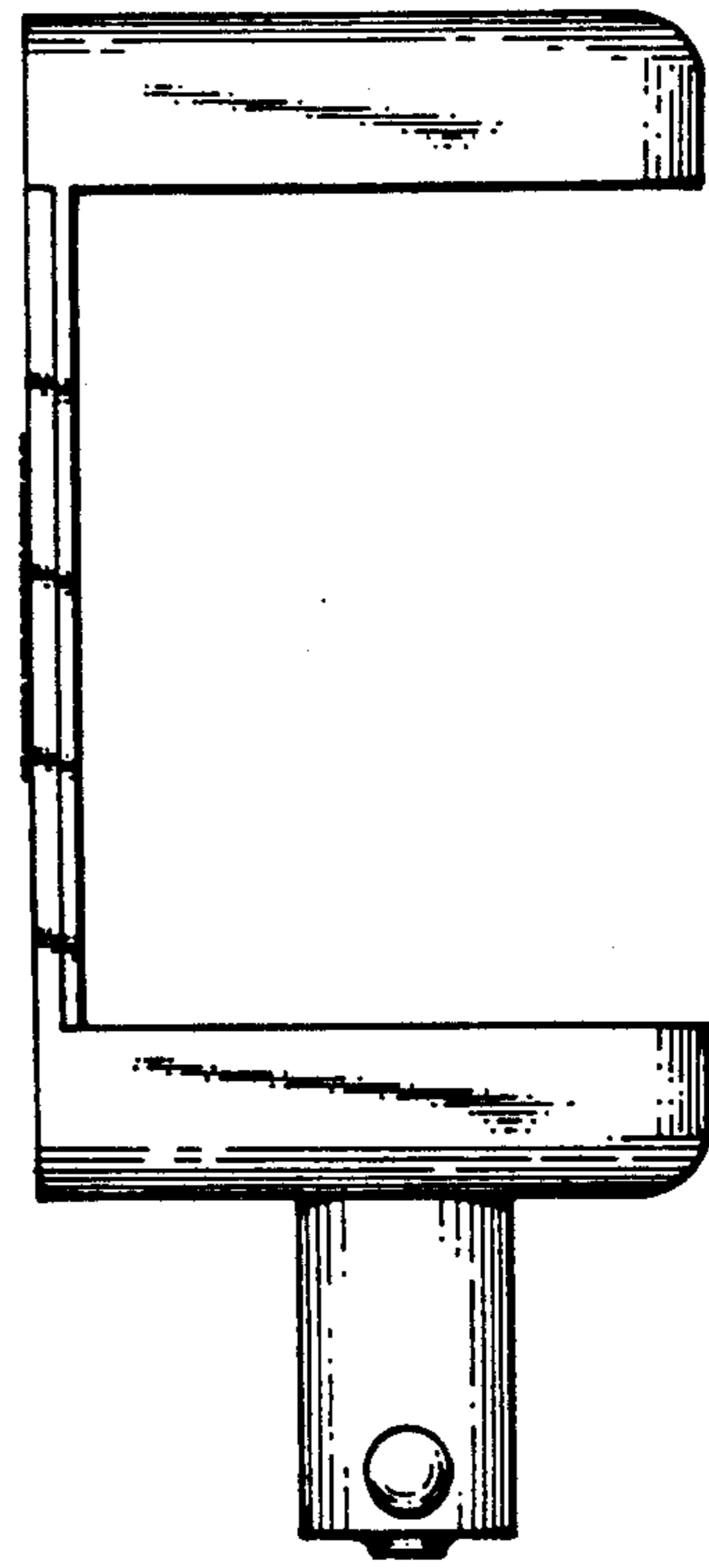

FIG. 11.

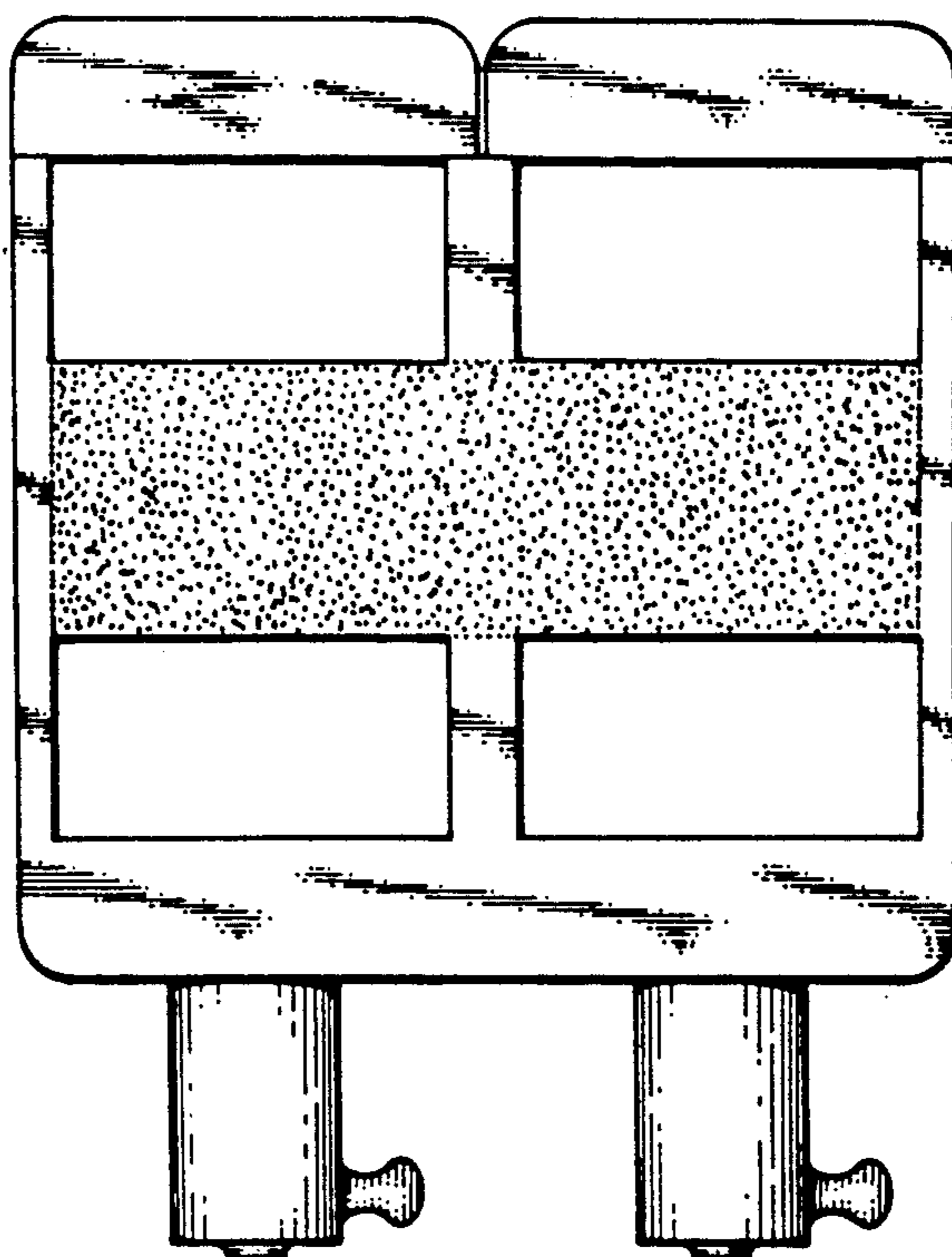

FIG. 12.

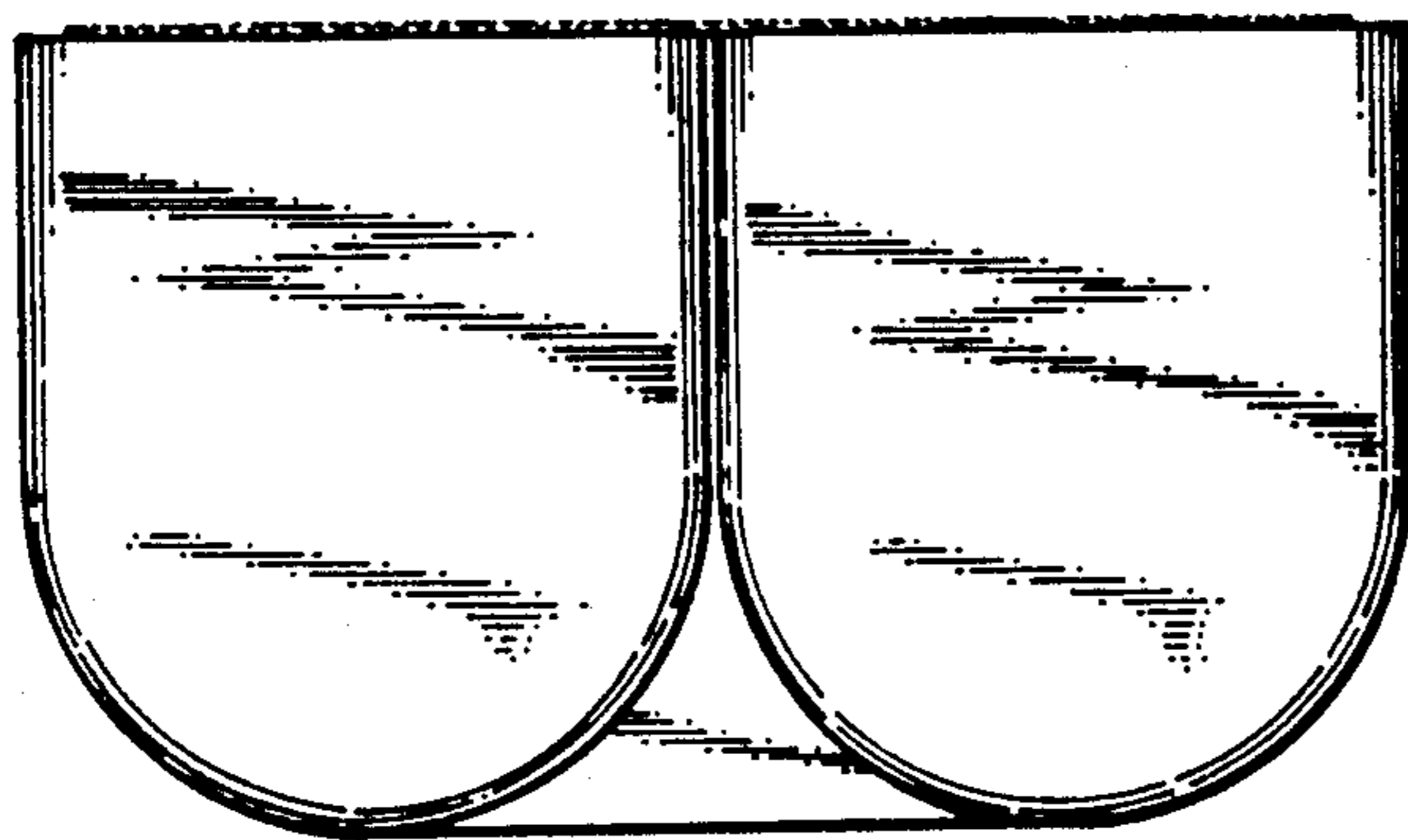

FIG. 13

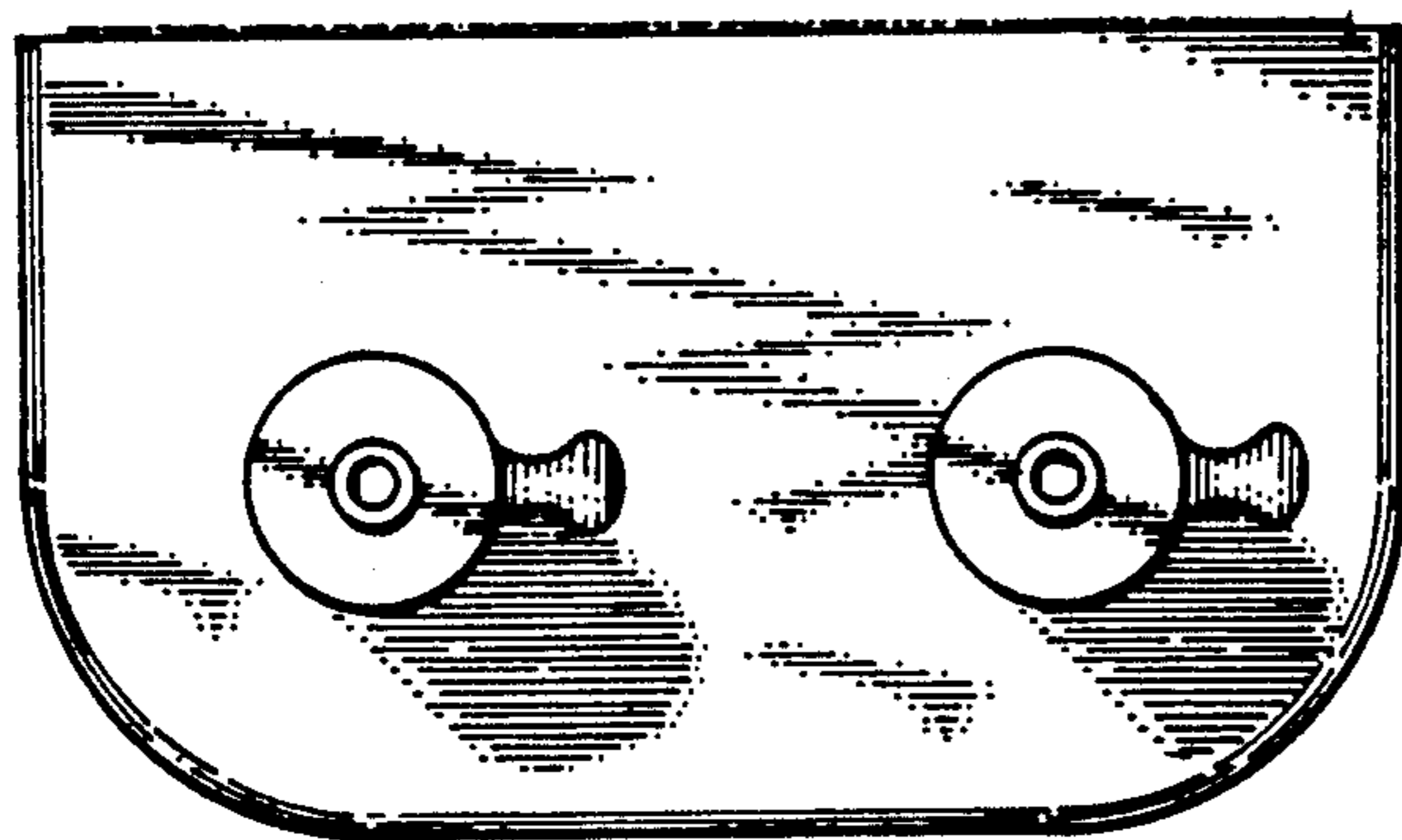

FIG. 14.

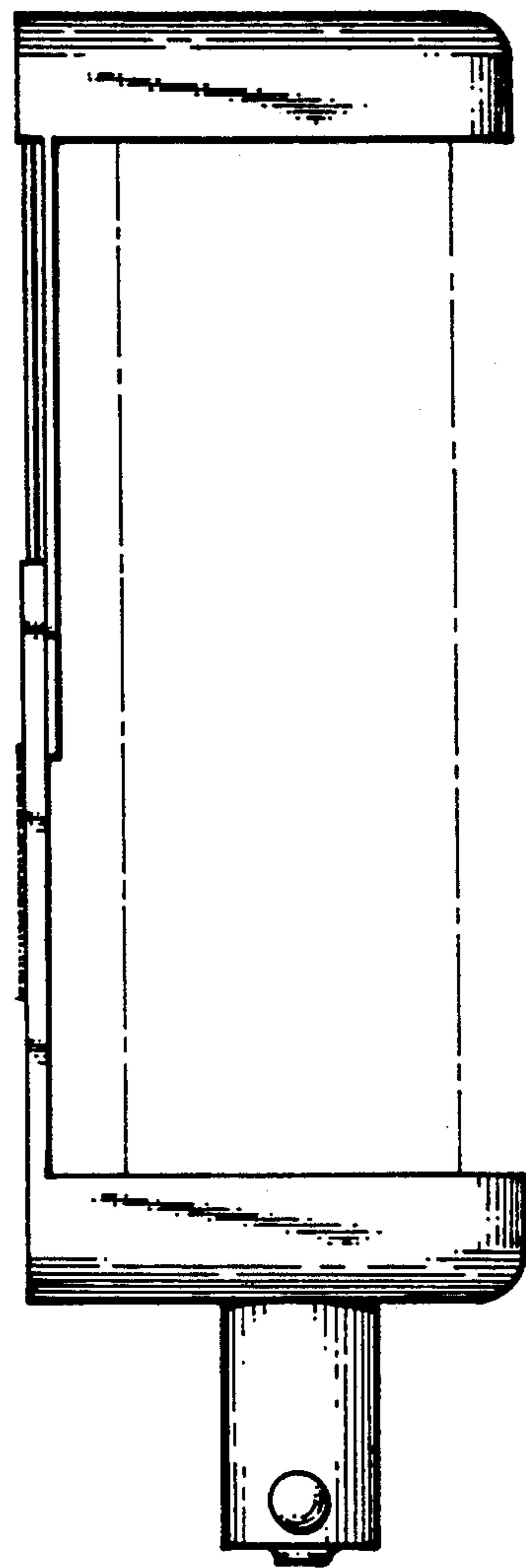

FIG. 15