



US00D333025S

United States Patent [19]

[11] Patent Number: **Des. 333,025**

Doherty

[45] Date of Patent: **** Feb. 2, 1993**

[54] **TRASH CONTAINER**

4,917,263 4/1990 Korb 220/400

[76] Inventor: **Jean Doherty, 331 Division Ave.,
Hasbrouck Heights, N.J. 07604-1721**

*Primary Examiner—Kay H. Chin
Attorney, Agent, or Firm—Terry M. Gernstein*

[**] Term: **14 Years**

[57] **CLAIM**

[21] Appl. No.: **675,709**

The ornamental design for a trash container, as shown and described.

[22] Filed: **Mar. 27, 1991**

DESCRIPTION

[52] U.S. Cl. **D34/7; D34/1**

[58] Field of Search **D34/1-11;
220/908, 909, 404, 403, 400, 407, 410**

FIG. 1 is an exploded top perspective view of a trash container showing my new design;

FIG. 2 is a front elevational view thereof, the rear elevational view being a mirror image of that shown;

FIG. 3 is a side elevational view thereof, the opposite side elevational view being a mirror image of that shown;

FIG. 4 is a top plan view thereof; and,

FIG. 5 is a bottom plan view thereof.

[56] **References Cited**

U.S. PATENT DOCUMENTS

- D. 203,631 2/1966 Kingsley D34/4
- D. 268,059 2/1983 Kracke D34/4
- 4,801,034 1/1989 Sandomeno 220/23.83

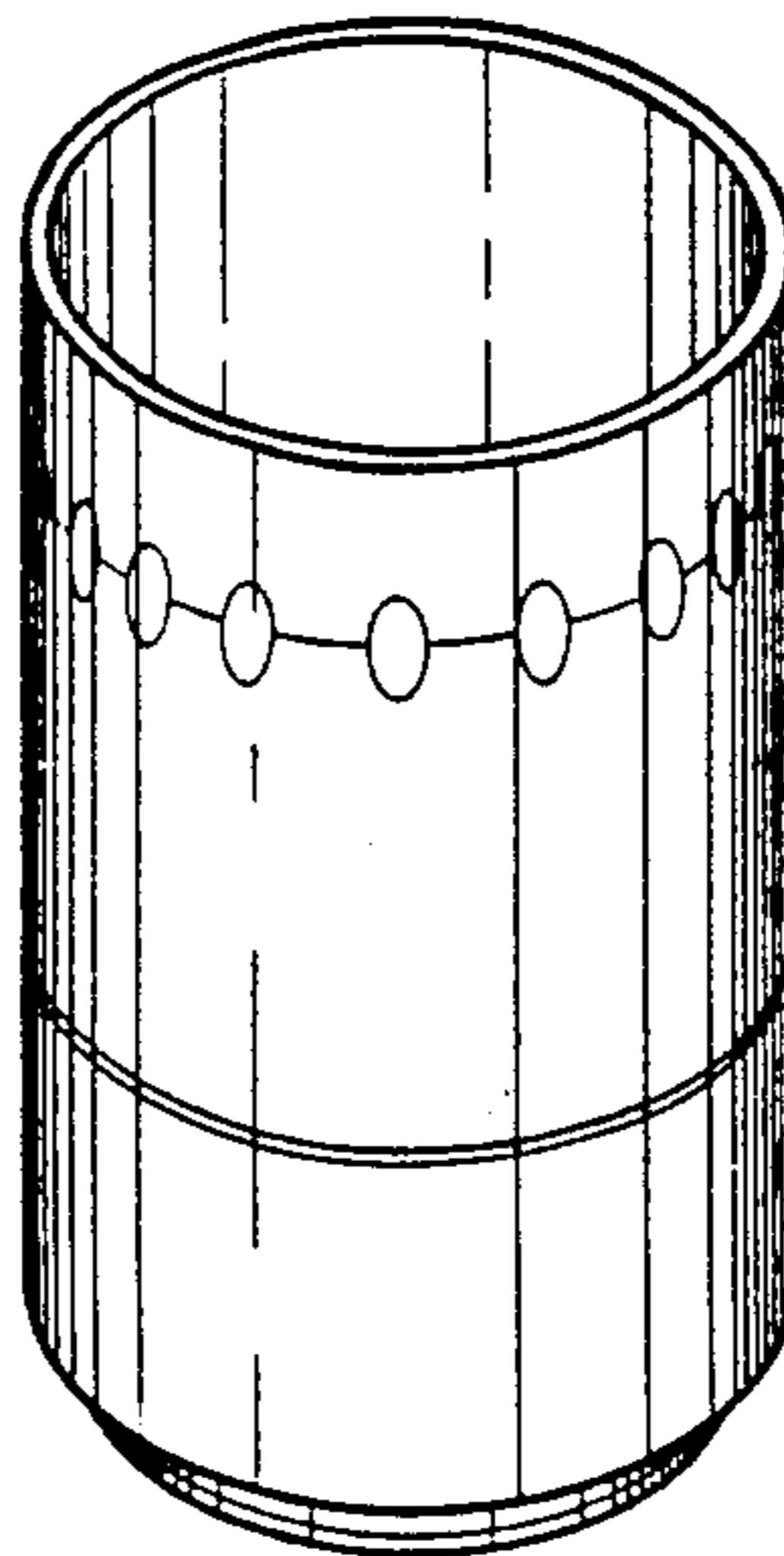
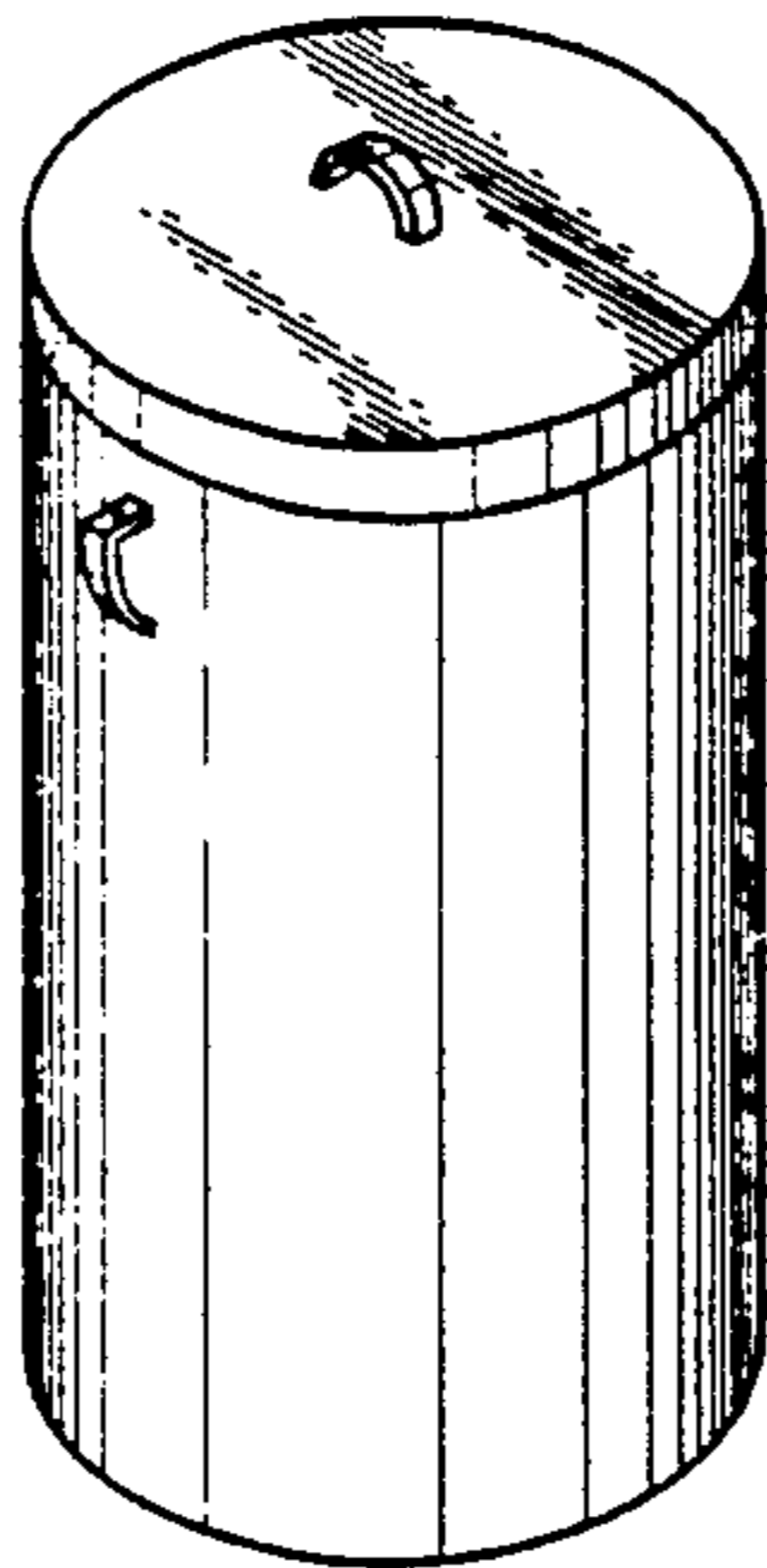
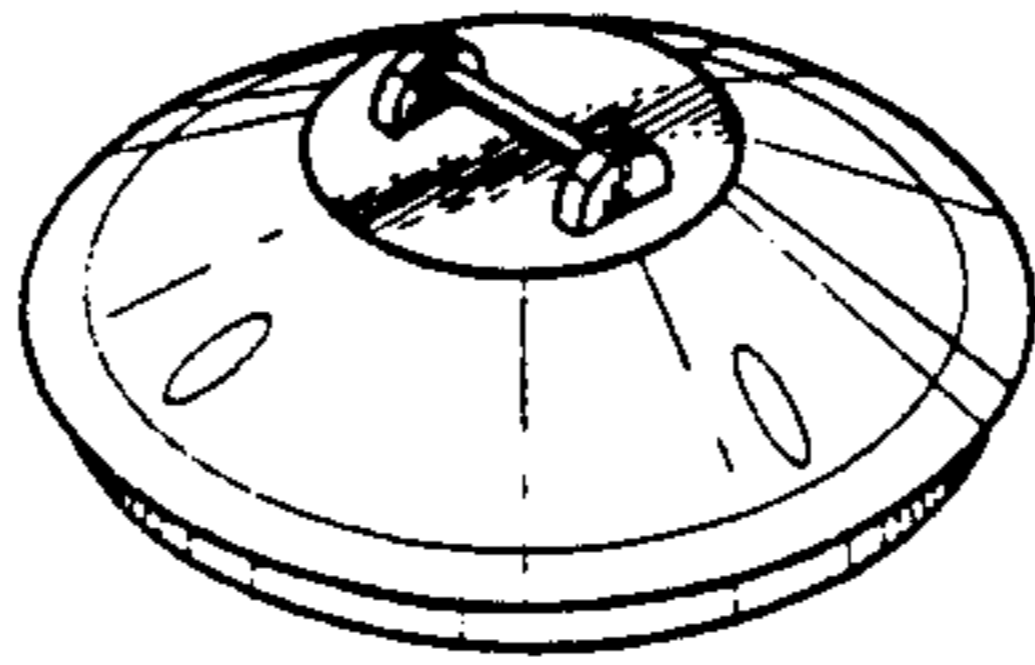

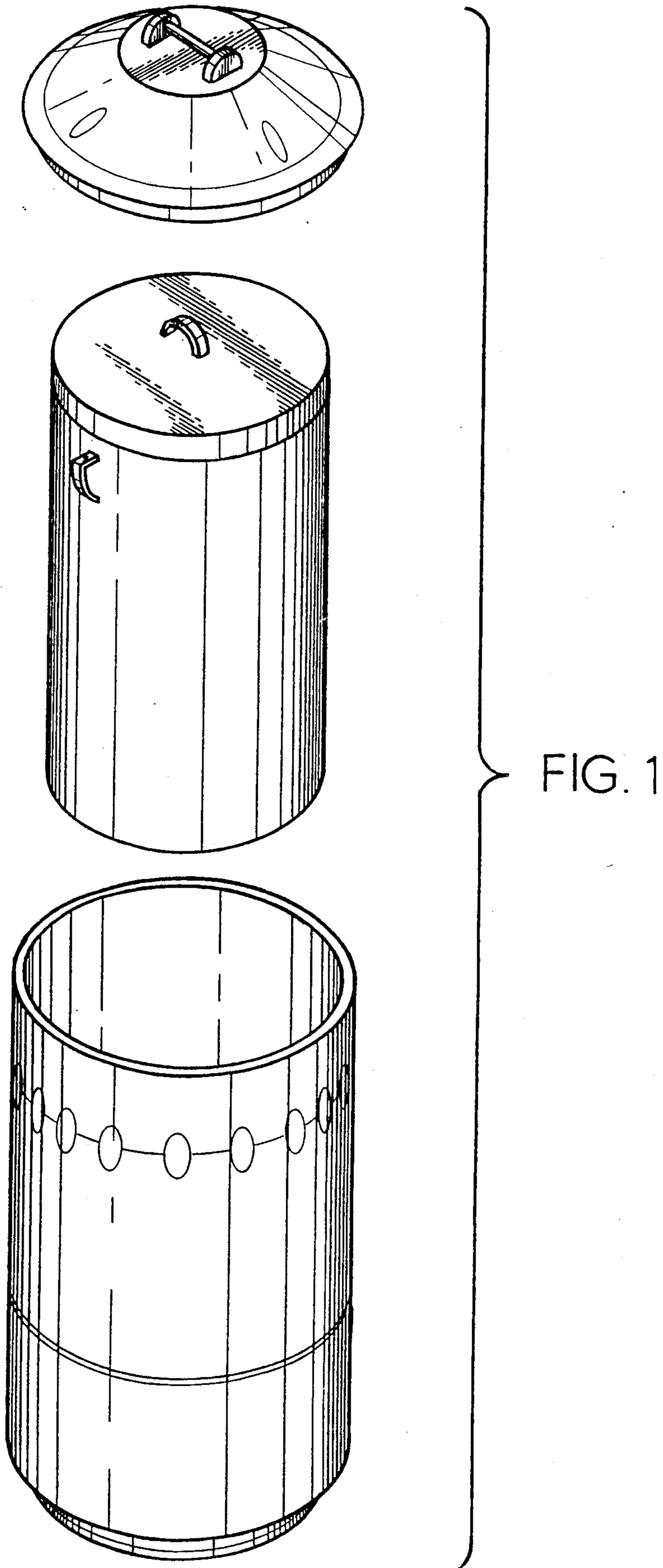

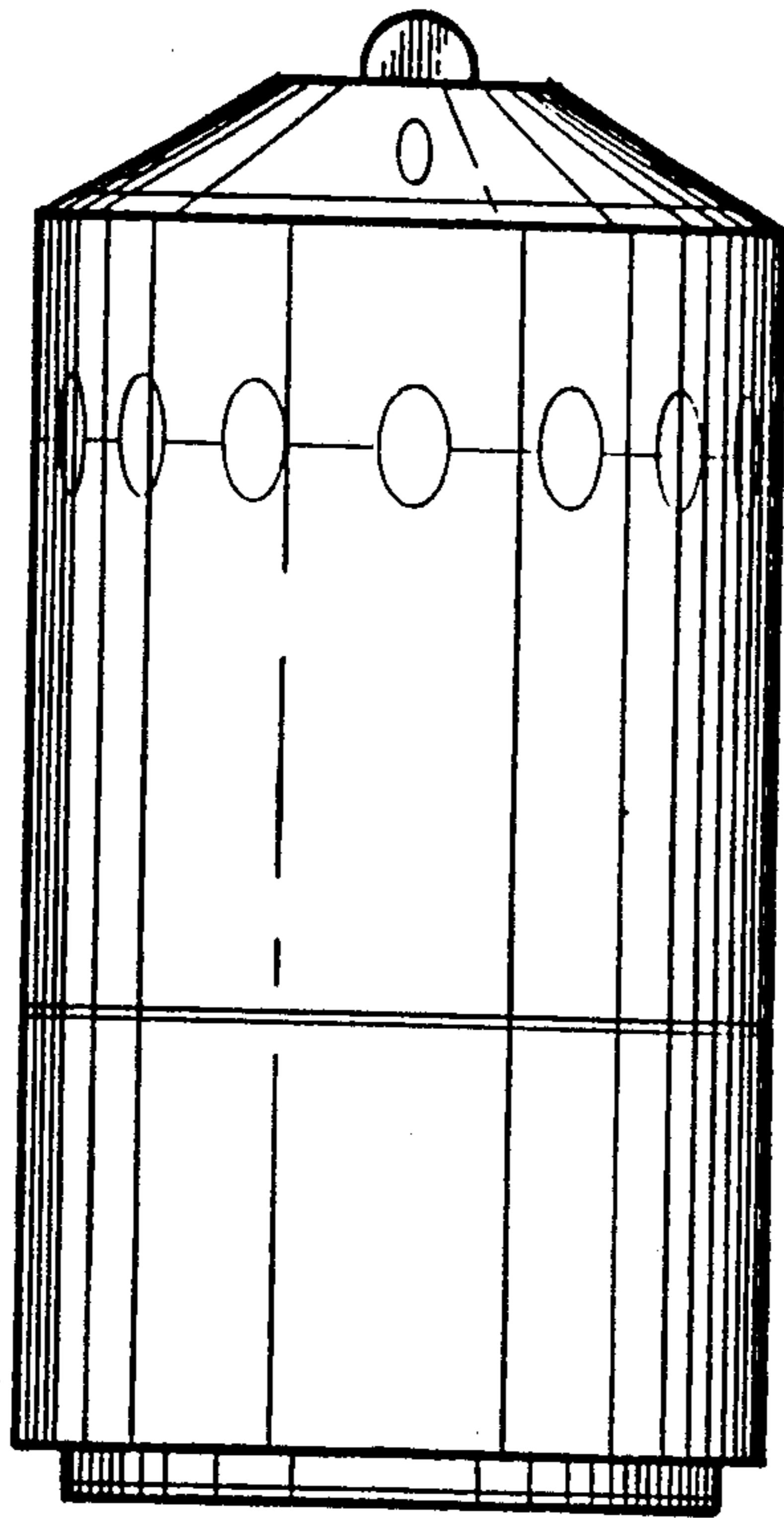

FIG. 2

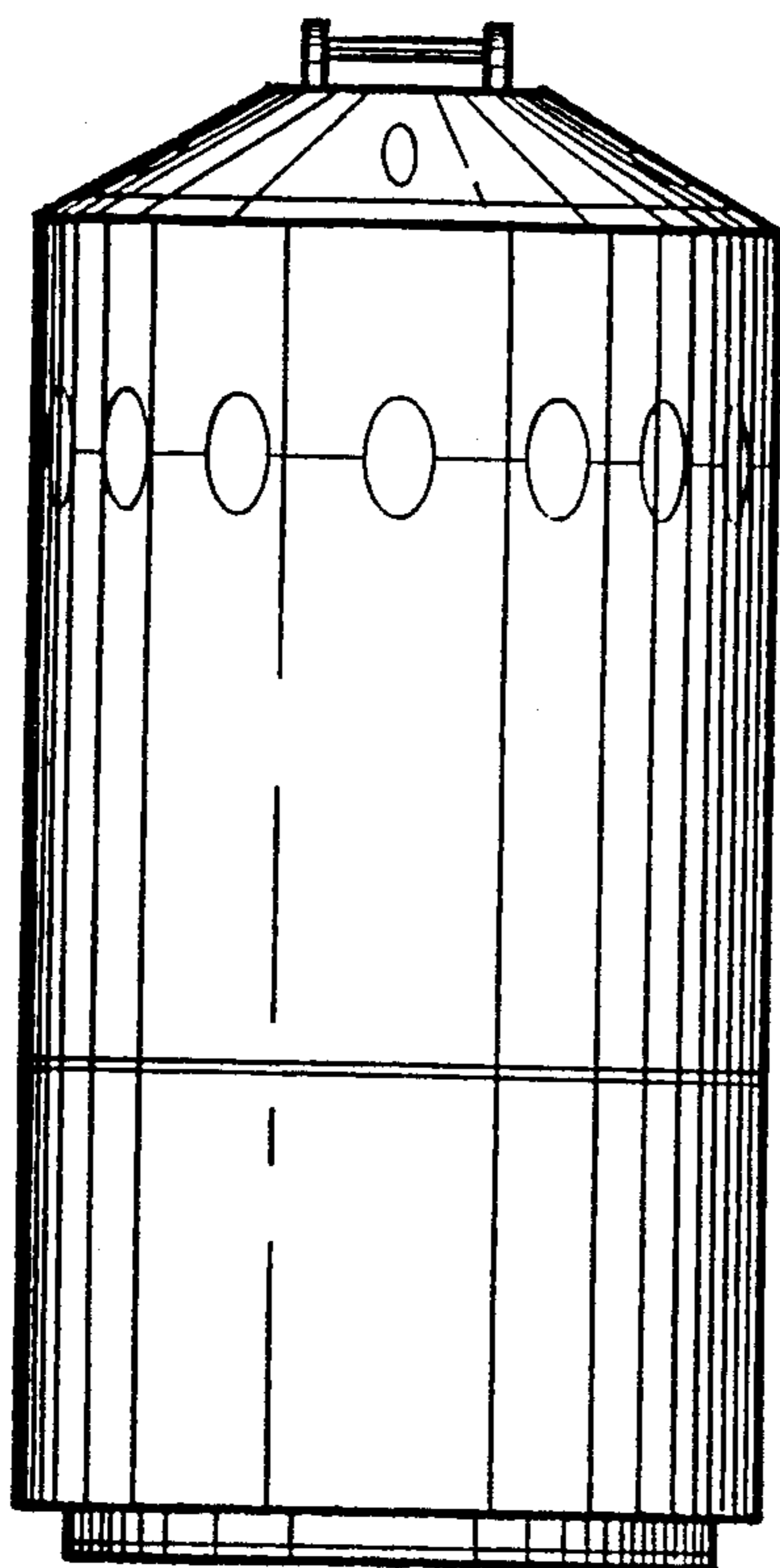

FIG. 3

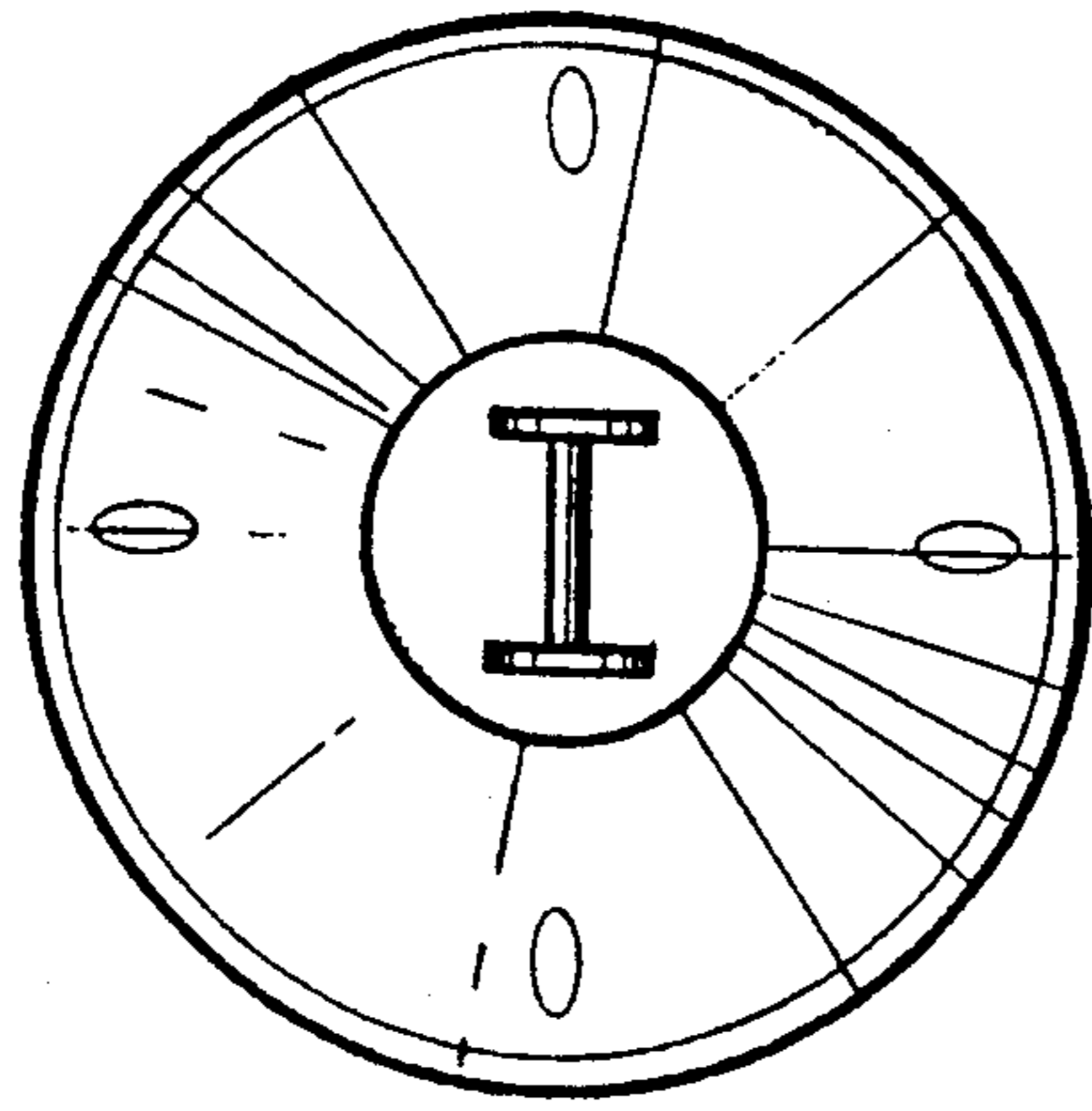

FIG. 4

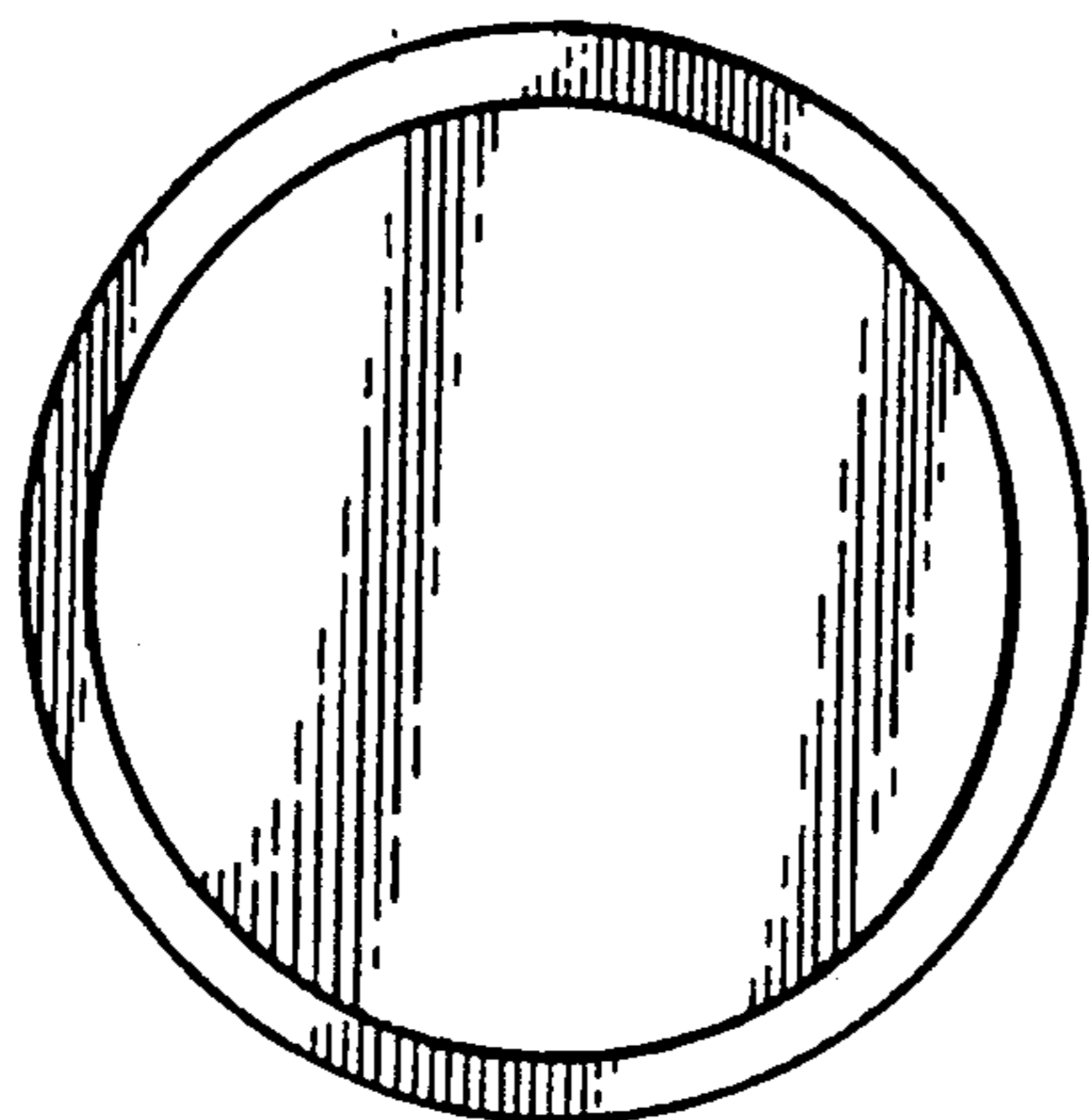

FIG. 5