



US00D333011S

# United States Patent [19]

[11] Patent Number: **Des. 333,011**

Ewing et al.

[45] Date of Patent: **\*\* Feb. 2, 1993**

[54] LUMINAIRE

D. 298,862 12/1988 Tharp ..... D26/88

[75] Inventors: **Robert L. Ewing, Granville; Peter A. Koloski, Columbus; Robert J. Hayes, Gahanna; Richard J. Malecha, Delaware; David G. Meredith, Westerville, all of Ohio**

### OTHER PUBLICATIONS

Thomas Lighting "Lighting Classics", Catalog, ©1985, p. 35, Steelite II Light Fixture (Gr-290-Ceiling Lamp Box).

*Primary Examiner*—Susan J. Lucas

[73] Assignee: **Holophane Company, Inc., Newark, Ohio**

### [57] CLAIM

The ornamental design for a luminaire, as shown and described.

[\*\*] Term: **14 Years**

### DESCRIPTION

[21] Appl. No.: **513,332**

FIG. 1 is a bottom, front perspective view of a luminaire showing our new design;  
FIG. 2 is a rear elevational view thereof;  
FIG. 3 is a side elevational view thereof, the opposite side being a mirror image;  
FIG. 4 is a bottom plan view thereof;  
FIG. 5 is a top plan view thereof;  
FIG. 6 is a side, rear perspective view thereof; and,  
FIG. 7 is a side, front perspective view thereof.

[22] Filed: **Apr. 20, 1990**

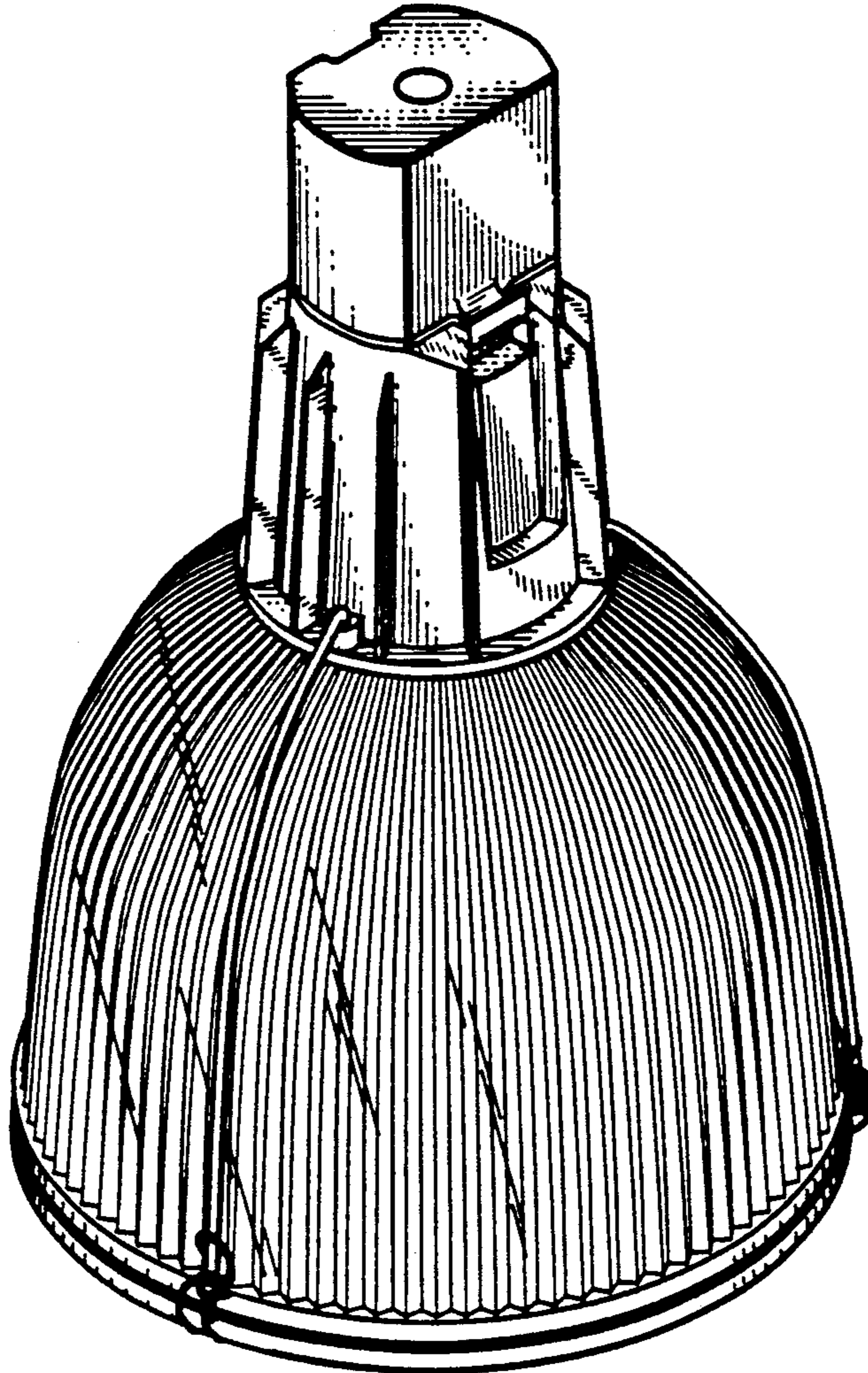
[52] U.S. Cl. .... **D26/88**

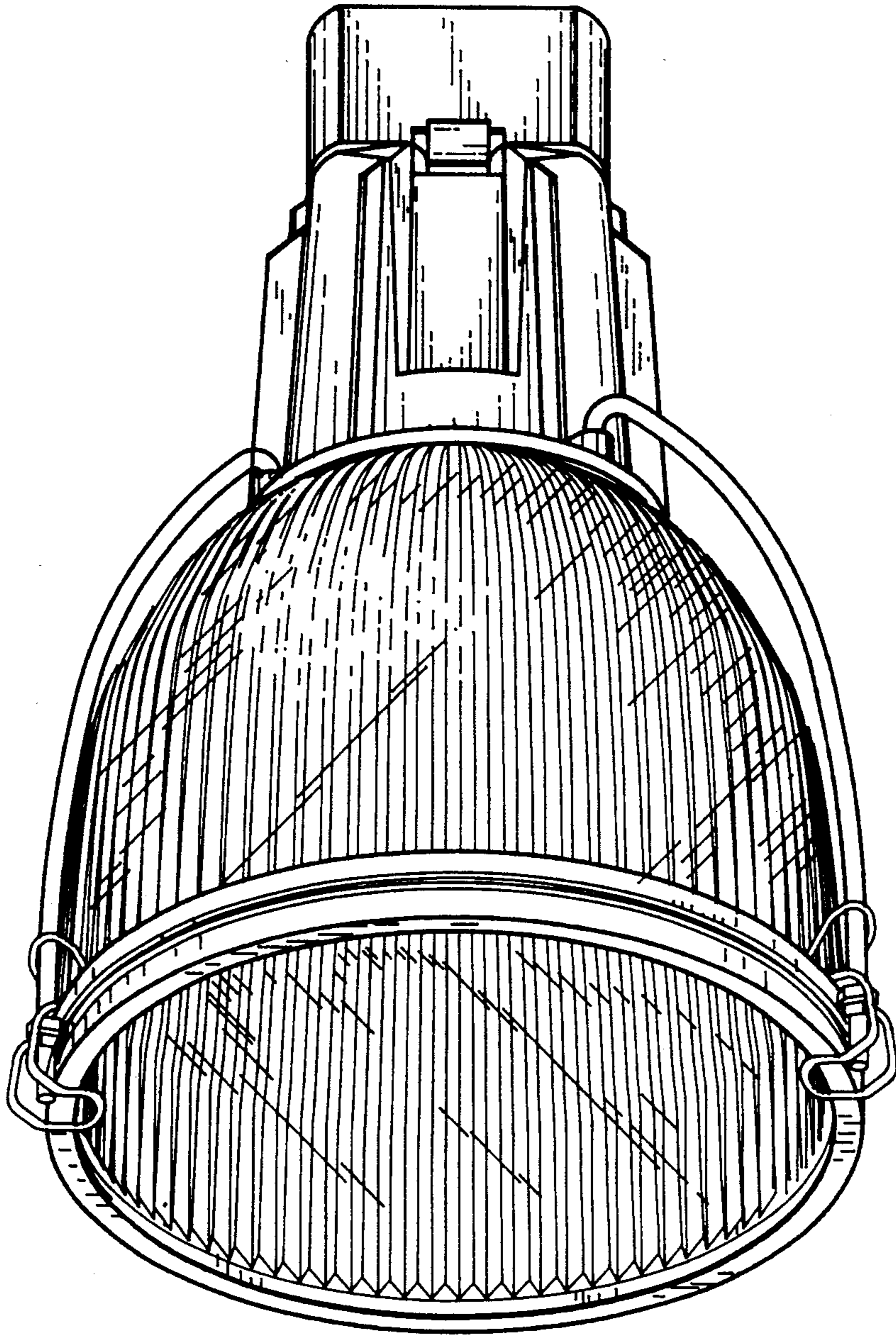
[58] Field of Search ..... **D26/72, 80-92; 362/147, 404-408, 222, 223, 362, 432**

### [56] References Cited

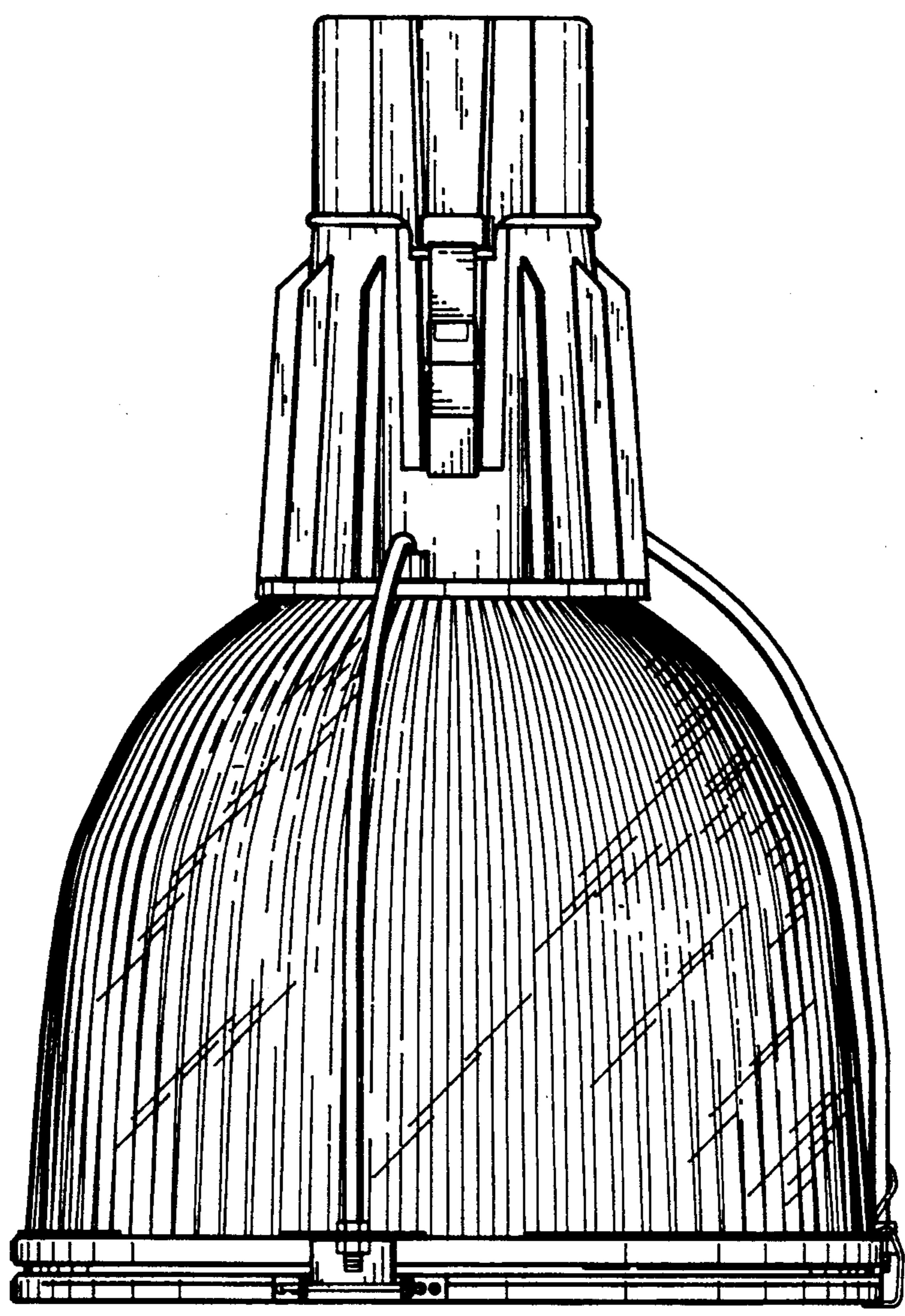
#### U.S. PATENT DOCUMENTS

D. 294,979 3/1988 Ewing ..... D26/85

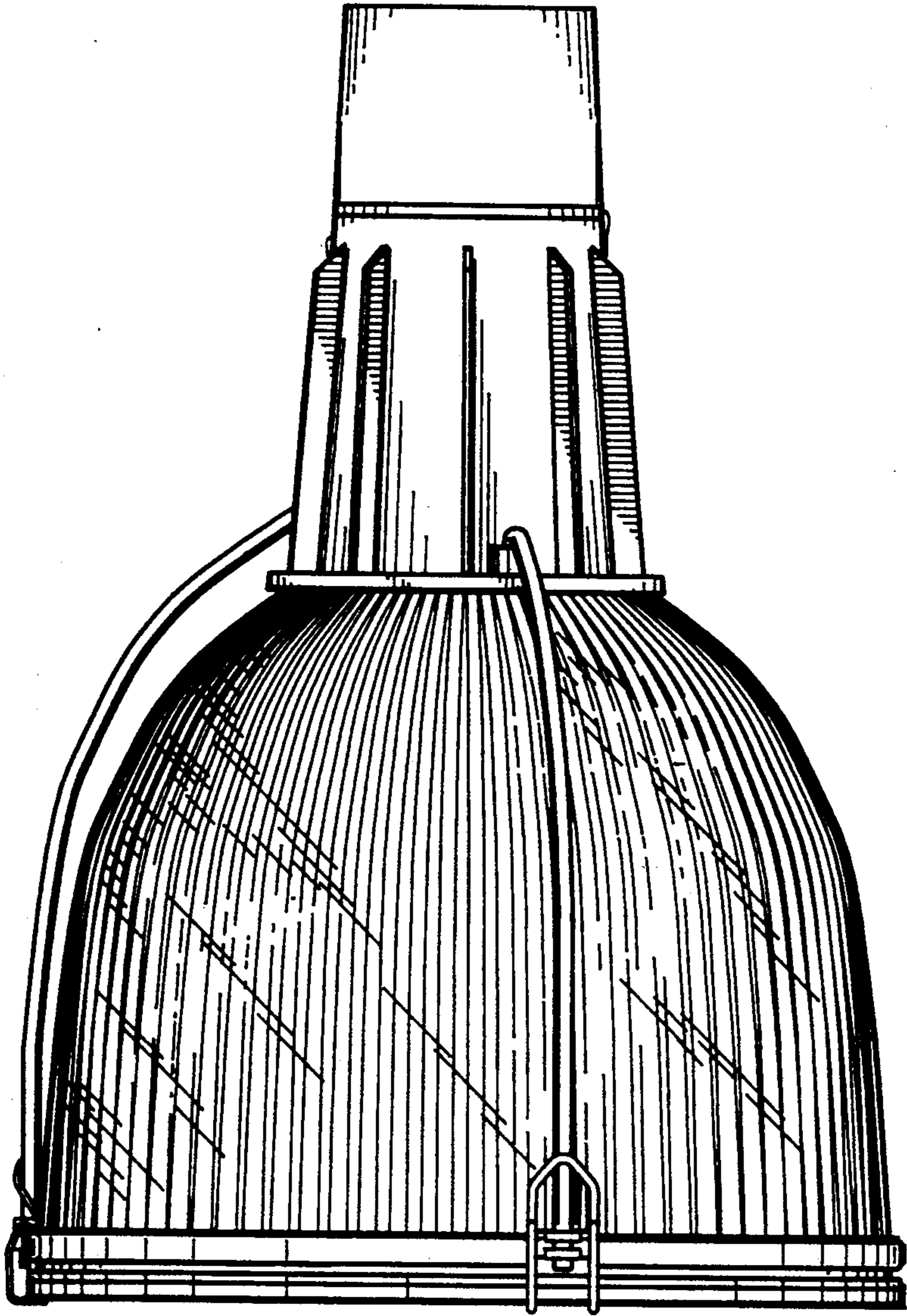




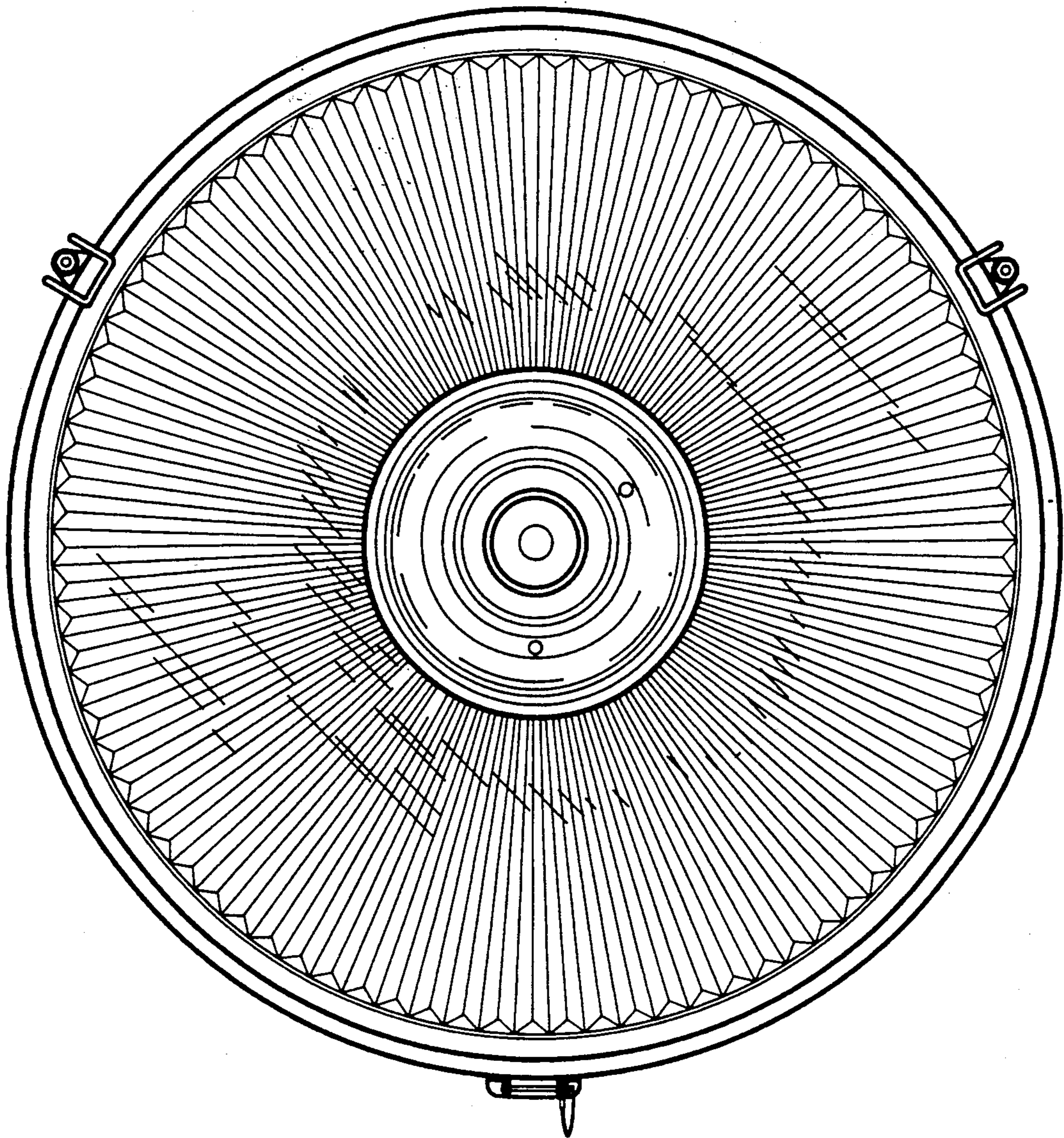
*Fig. 1*



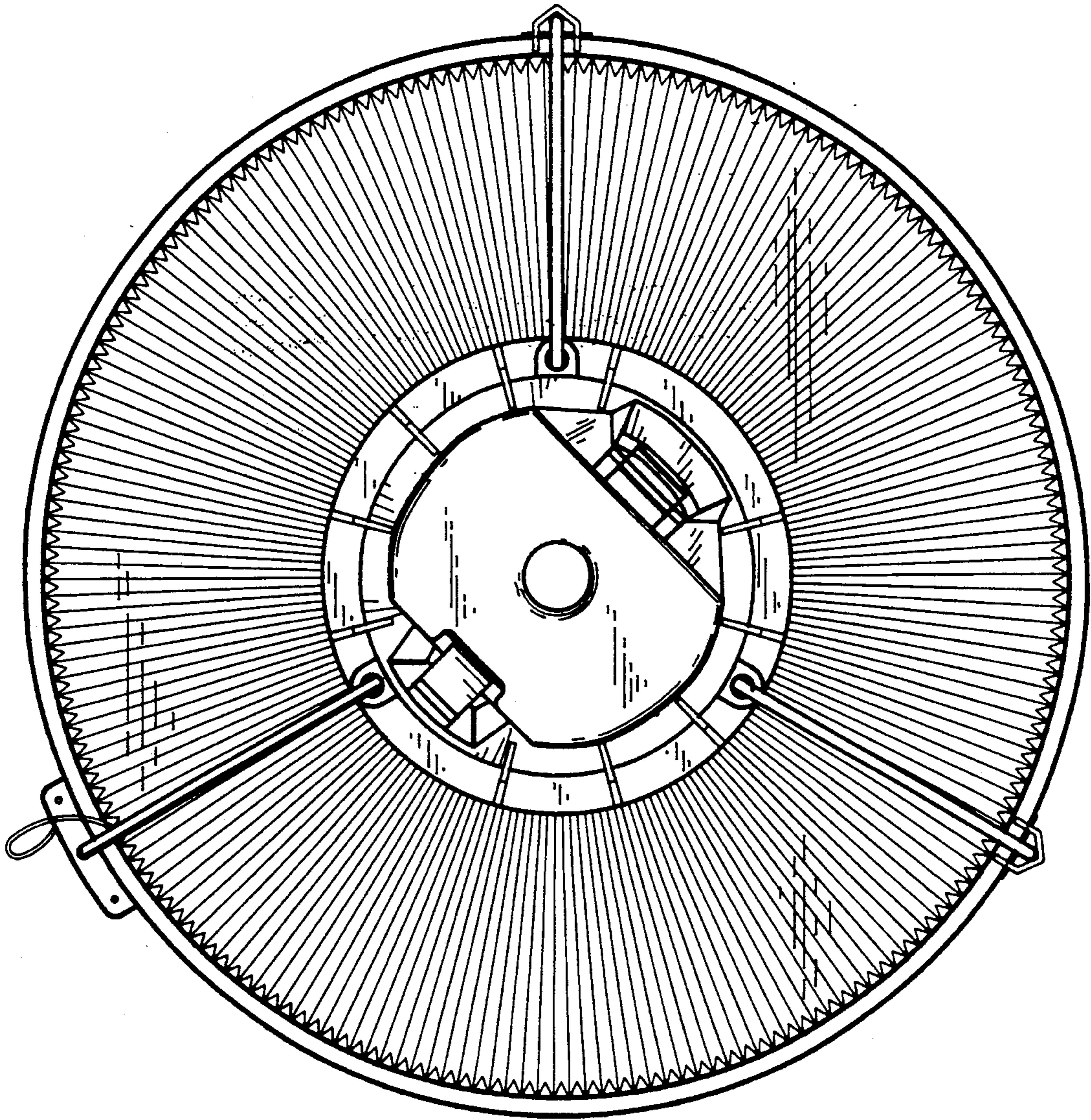
*Fig. 2*



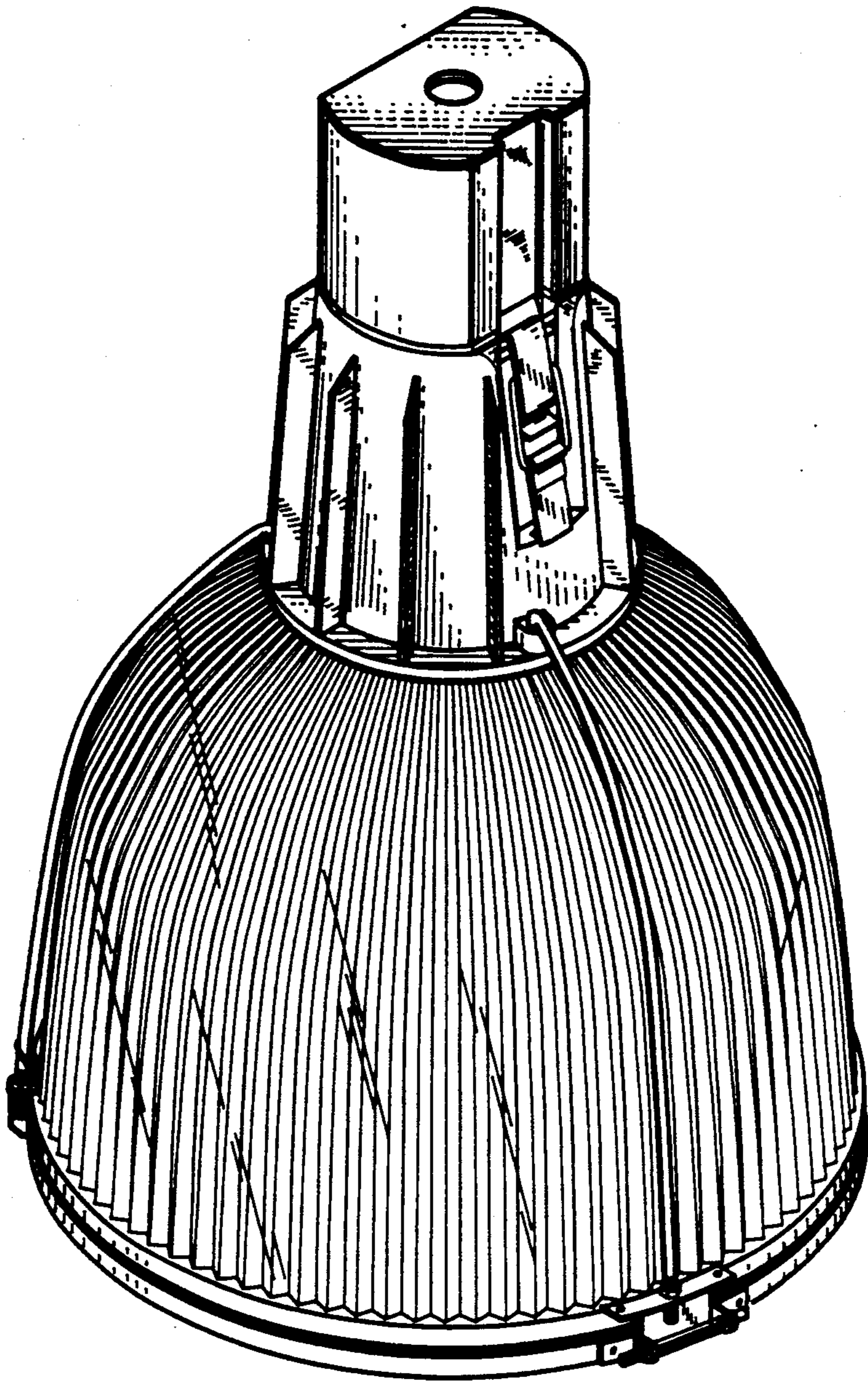
*Fig. 3*



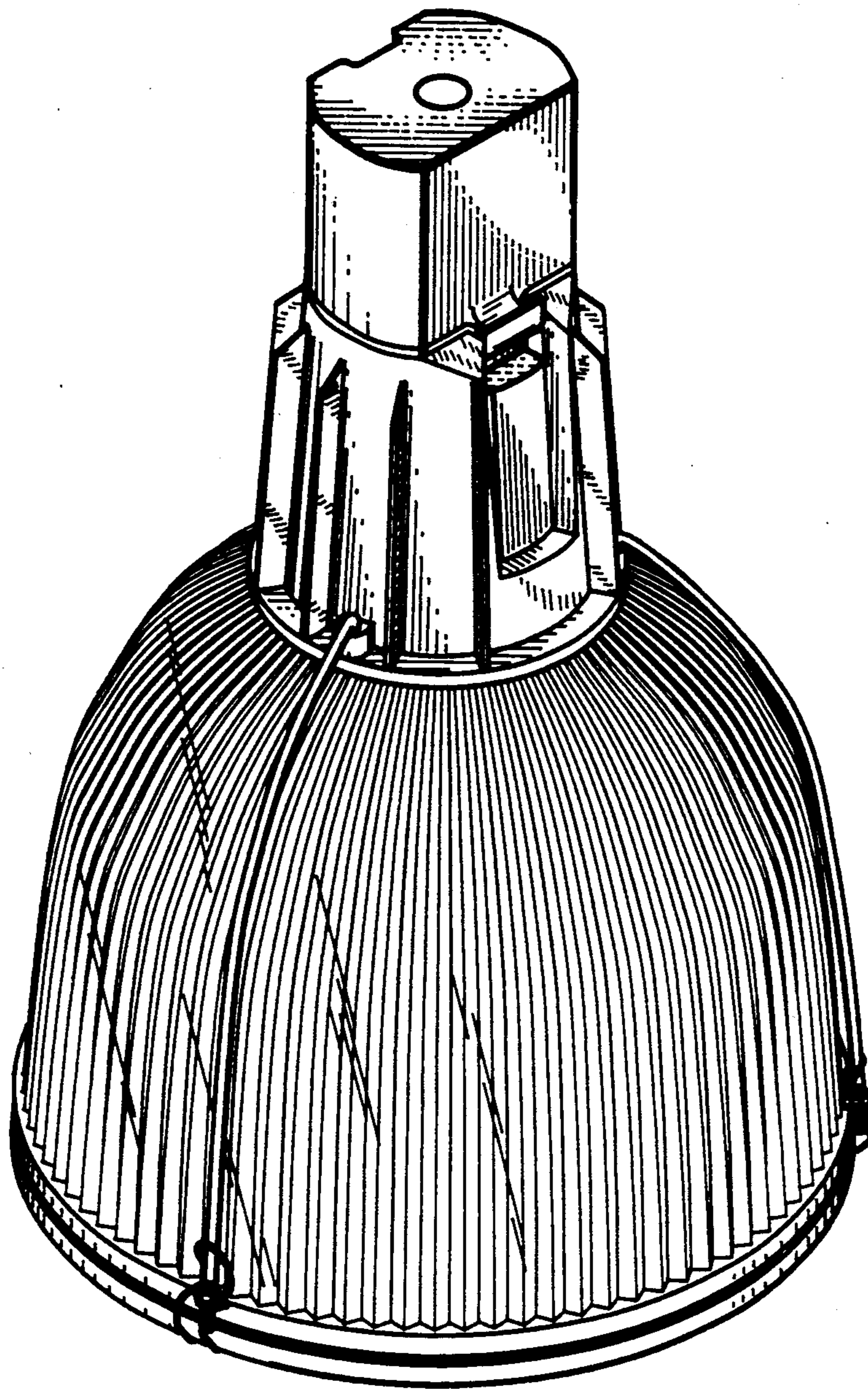
*Fig. 4*



*Fig. 5*



*Fig. 6*



*Fig. 7*