



US00D332996S

United States Patent [19]

[11] **Patent Number: Des. 332,996**

Hart et al.

[45] **Date of Patent: ** Feb. 2, 1993**

[54] **LAVATORY**

OTHER PUBLICATIONS

[75] **Inventors:** Richard S. Hart, Elgin; Jeffrey P. Heuel, Elmhurst, both of Ill.; Thomas R. Nusz, Hockessin, Del.; Richard A. Valiga, Bartlett, Ill.

Trade literature "Kohler" Farmington™ Lavatory pp. 8-15, 1987.
Kohler Co. Form P-1205-188 pp. 4 & 15-17 & back cover (1988).
Luwa Corp. LV019/86 (1986).
Blanco 114/USA-CLB/7-88WD (1988).

[73] **Assignee:** E. I. Du Pont de Nemours and Company, Wilmington, Del.

Primary Examiner—James R. Largen
Attorney, Agent, or Firm—Richard H. Burgess

[**] **Term:** 14 Years

[57] **CLAIM**

The ornamental design for a lavatory, as shown and described.

[21] **Appl. No.:** 551,125

DESCRIPTION

[22] **Filed:** Jul. 11, 1990

FIG. 1 is a top plan view of a lavatory showing our new design;

[52] **U.S. Cl. D23/294**

FIG. 2 is a cross sectional view taken on line 2—2 of FIG. 1;

[58] **Field of Search D23/271-274,**

FIG. 3 is a cross sectional view taken on line 3—3 of FIG. 1;

D23/284-294; 4/619, 625-642, 652, 654, 665

FIG. 4 is a cross sectional view taken on line 4—4 of FIG. 1;

[56] **References Cited**

U.S. PATENT DOCUMENTS

D. 217,608	5/1970	Edgar	D23/294
D. 218,520	8/1970	Audino et al.	D23/294
D. 220,396	4/1971	Skyhawk	D23/294
D. 224,307	7/1972	Bogna	D23/294
D. 229,692	12/1973	Ganger	D23/294
D. 231,675	5/1974	Fee	D23/294

FIG. 5 is a cross sectional view taken on line 5—5 of FIG. 1;

FIG. 6 is a cross sectional view taken on line 6—6 of FIG. 1;

FIG. 7 is a cross sectional view taken on line 7—7 of FIG. 1; and,

FIG. 8 is a top perspective view thereof.

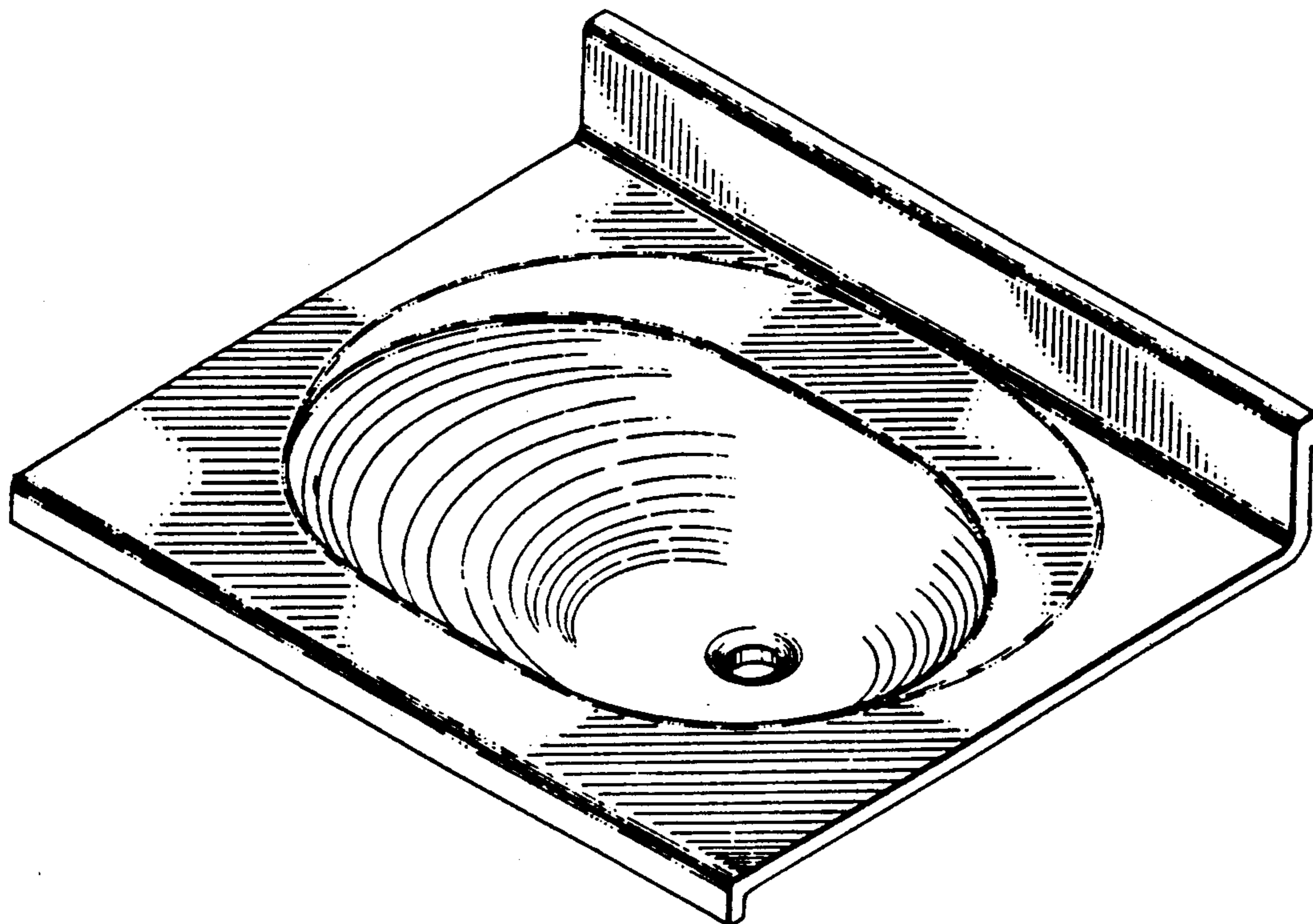

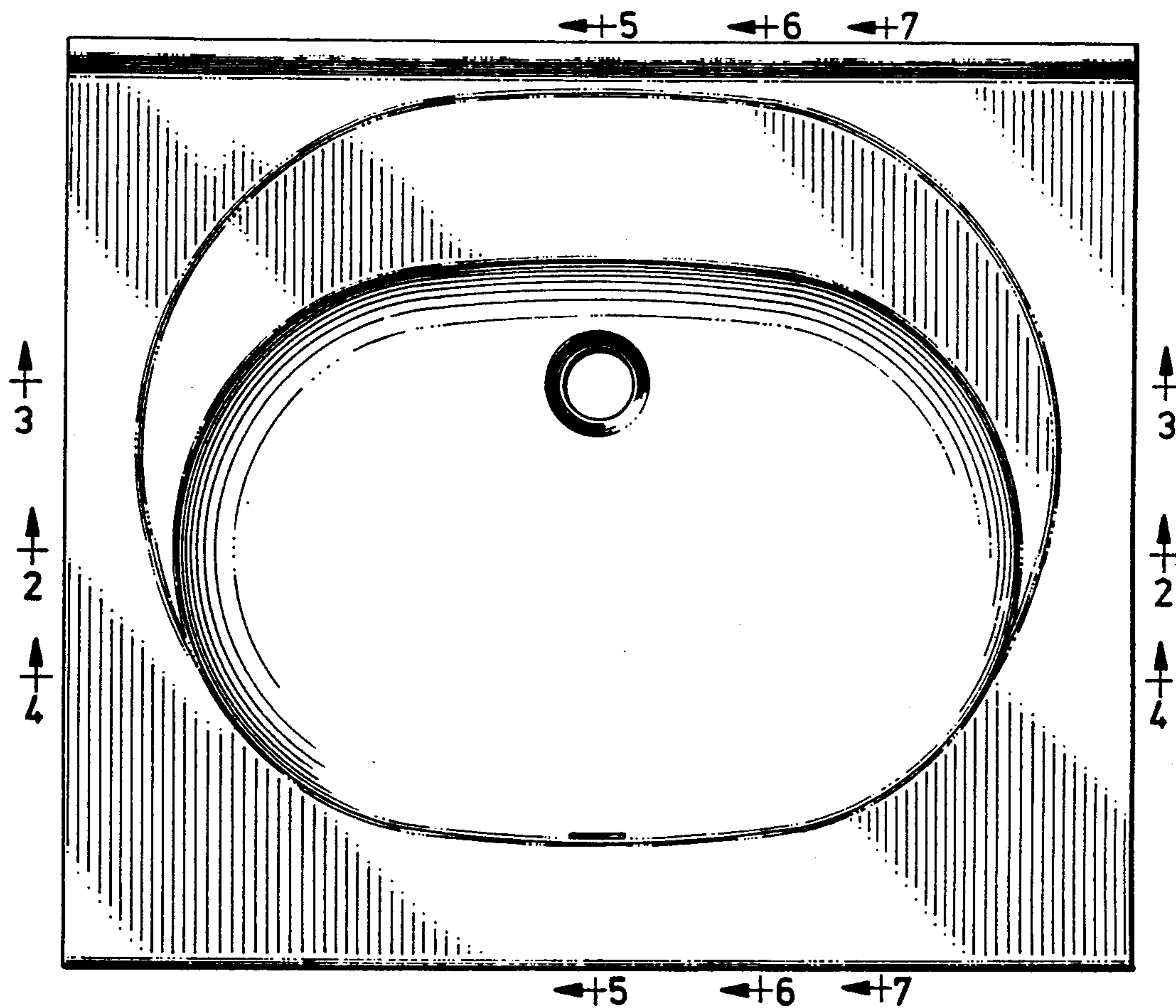

FIG. 1

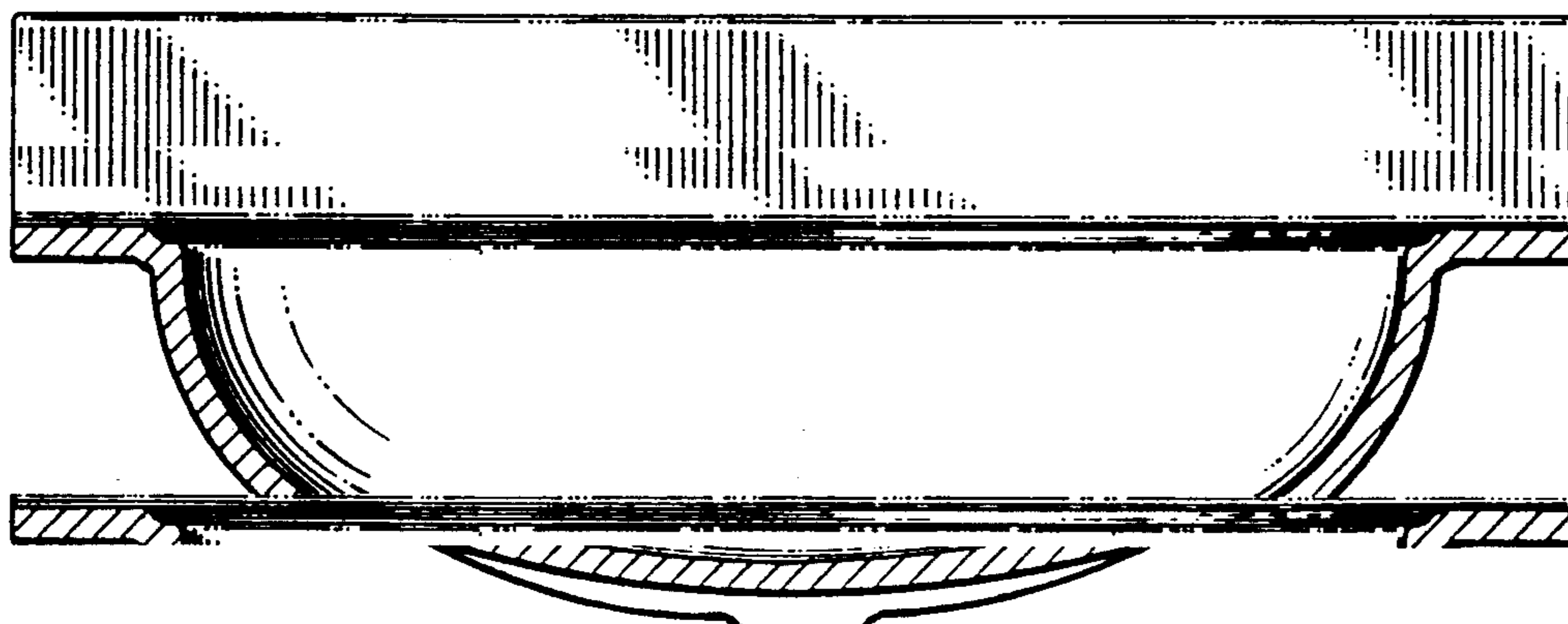

FIG. 2

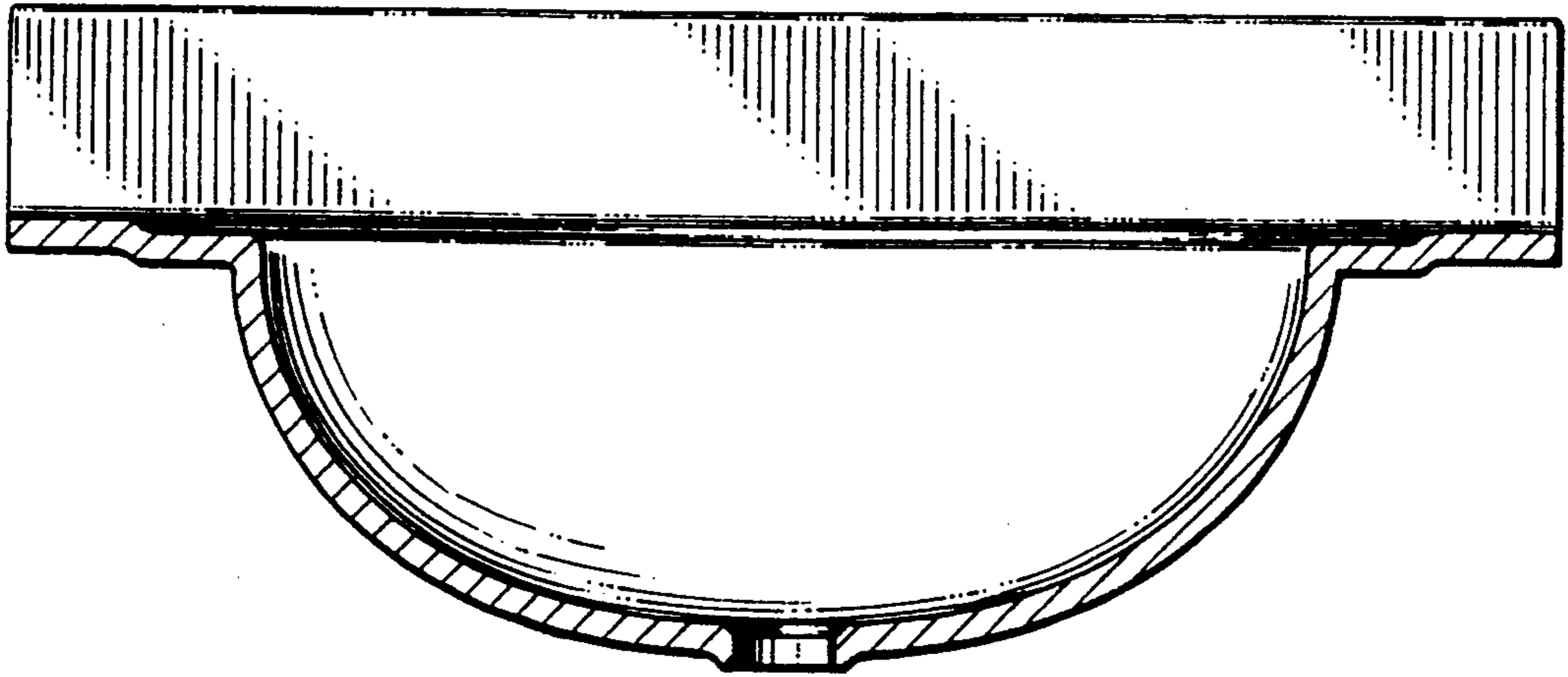

FIG. 3

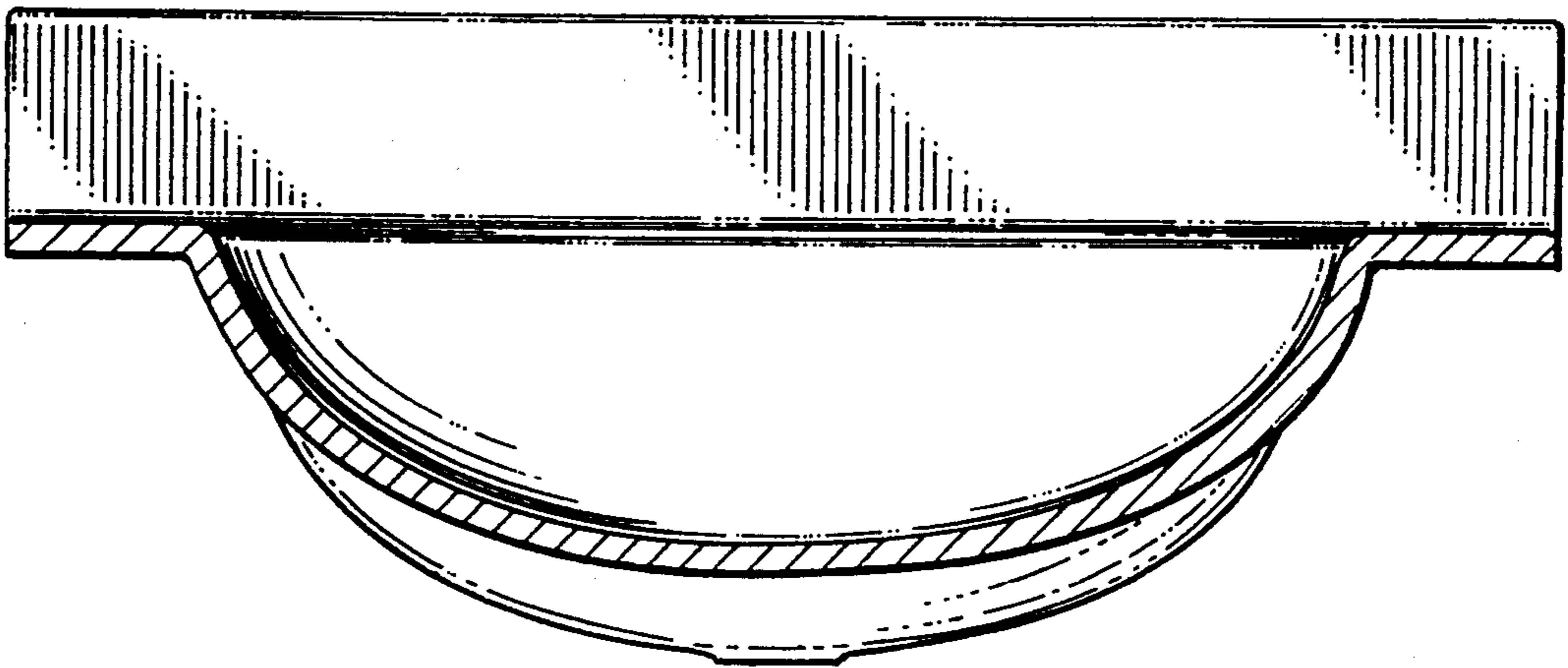

FIG. 4

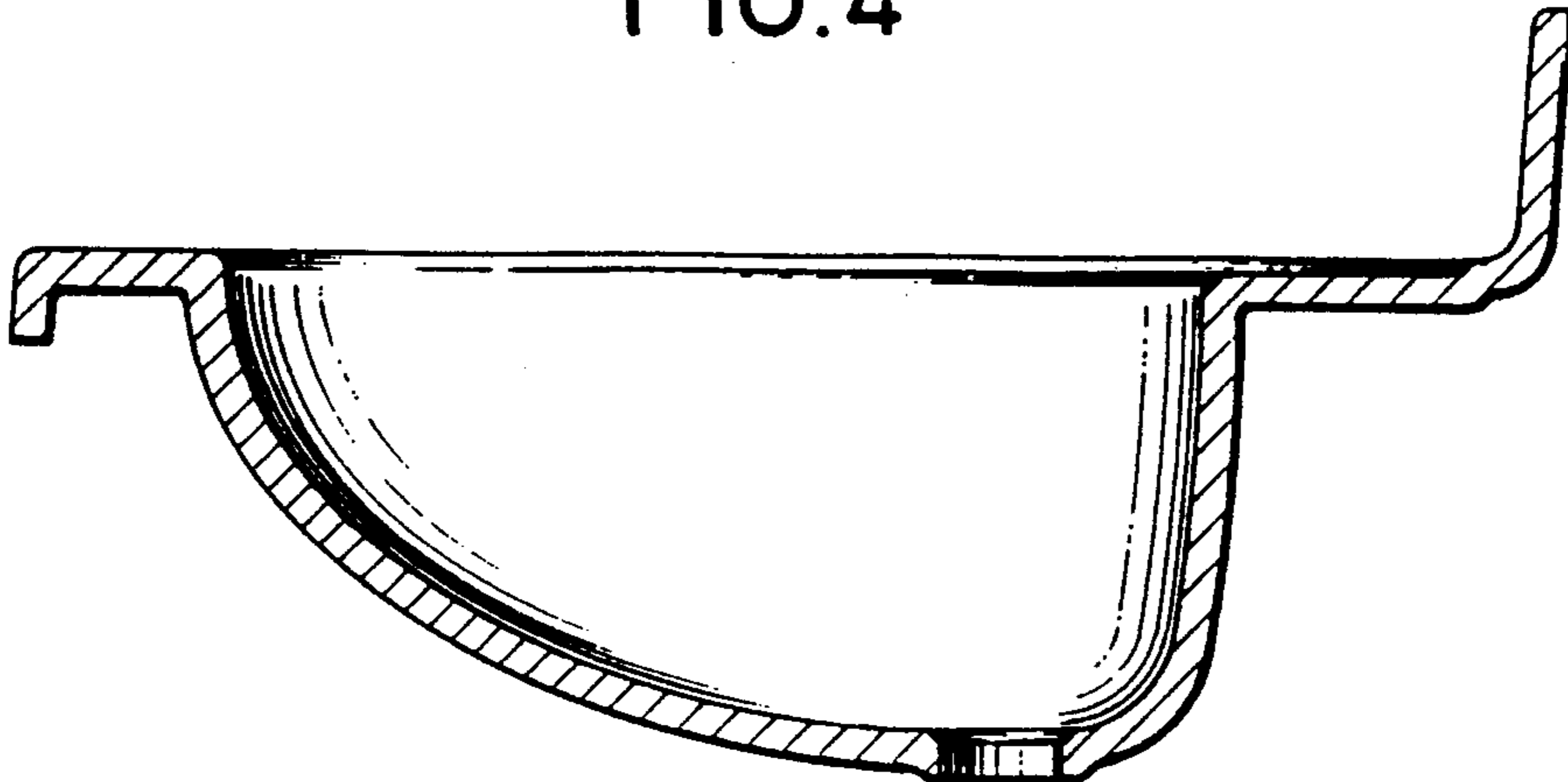

FIG. 5

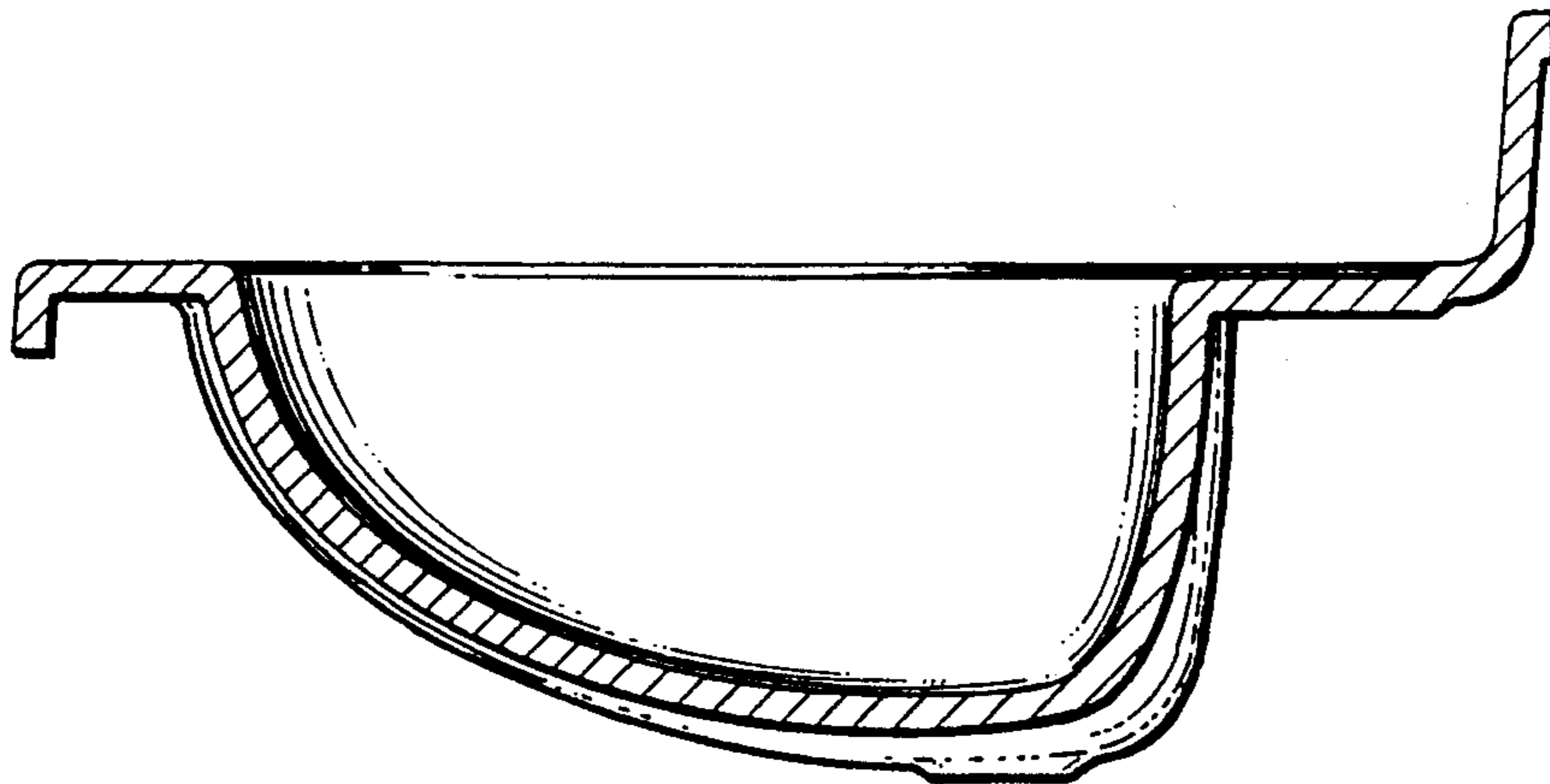

FIG. 6

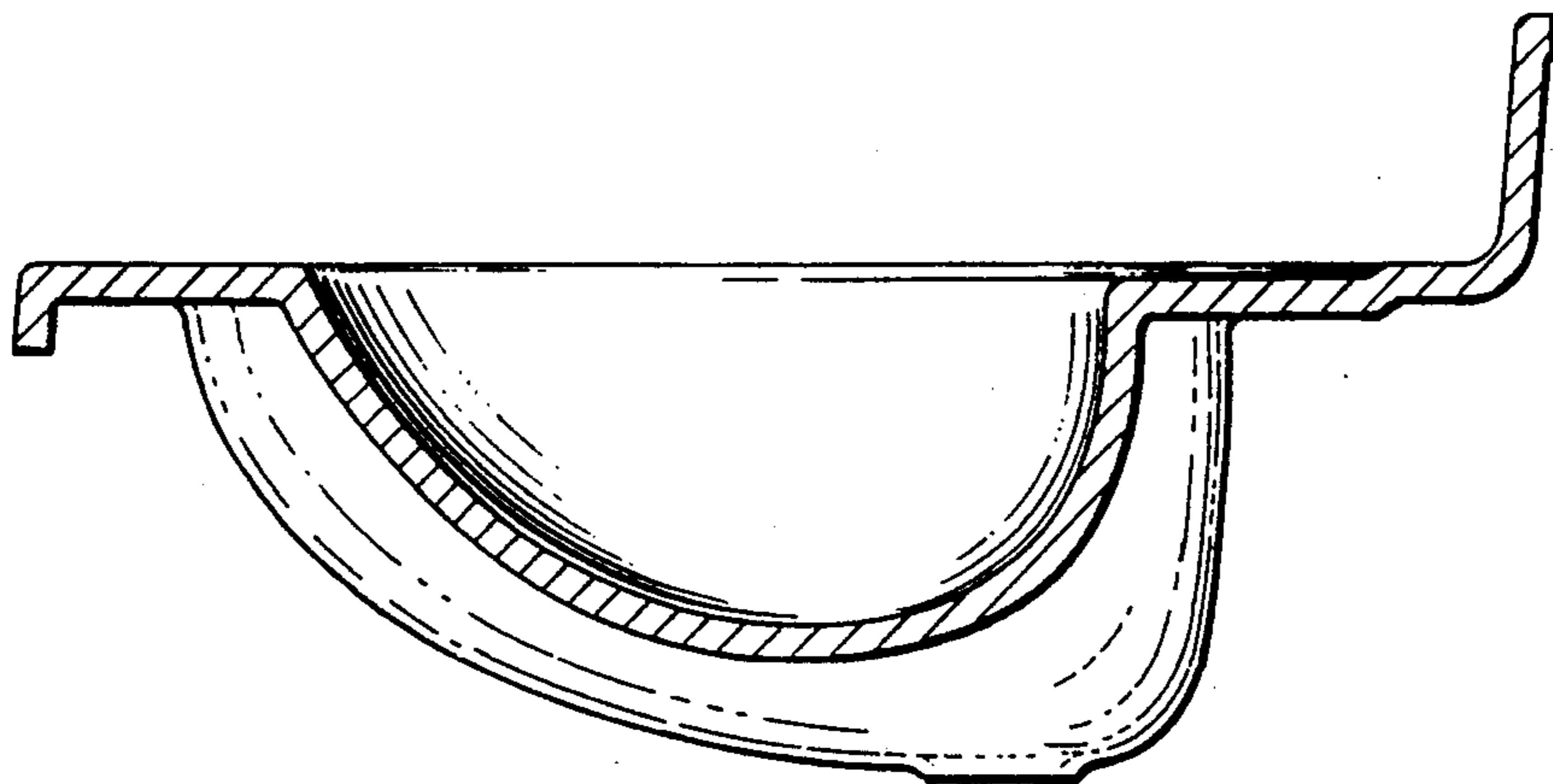

FIG. 7

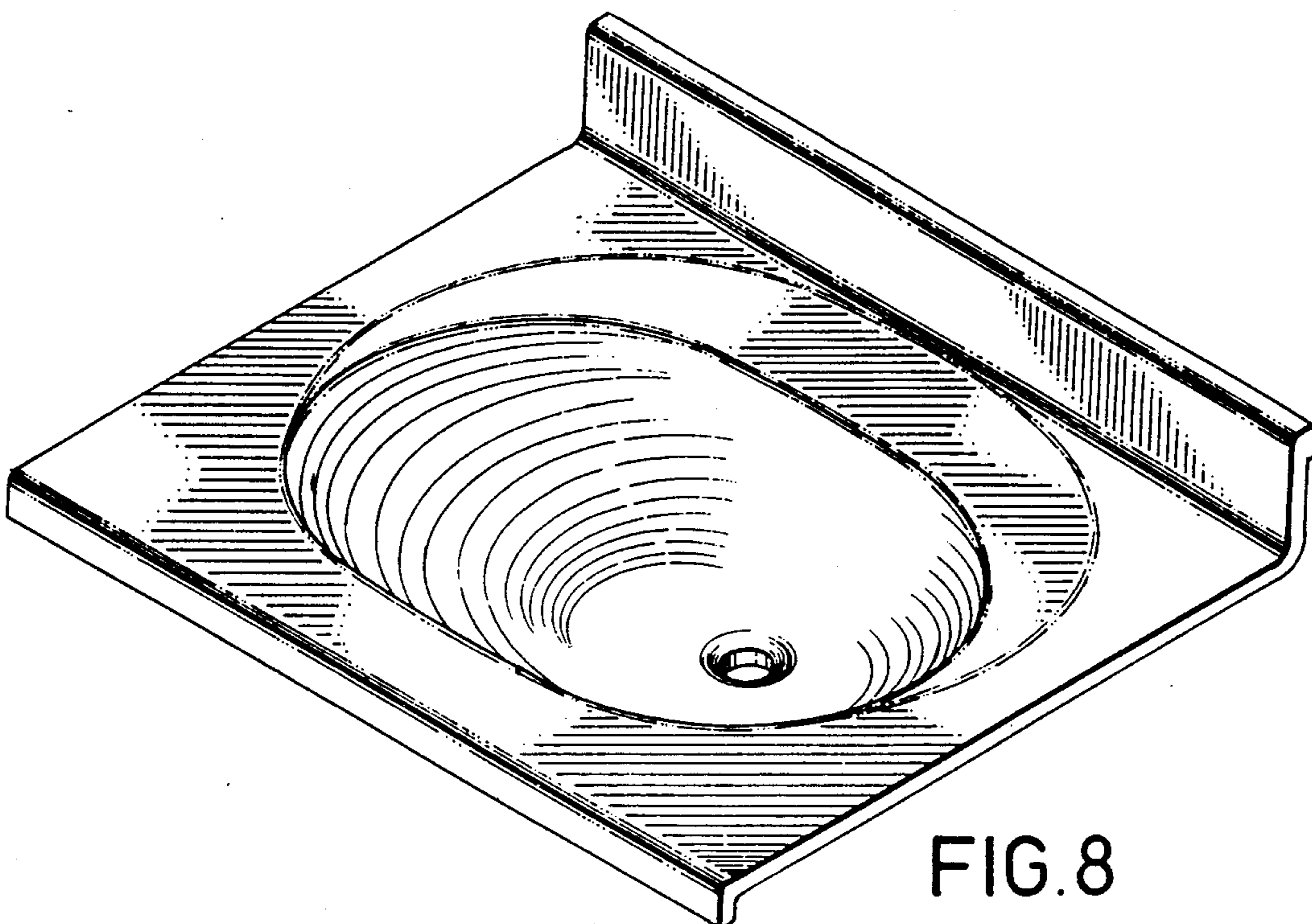

FIG. 8