



US00D332806S

# United States Patent [19]

[11] Patent Number: **Des. 332,806**

**Blimline**

[45] Date of Patent: **\*\* Jan. 26, 1993**

- [54] **COMBINED BASEBALL GAME, SCORE PAD, AND PEN**
- [76] Inventor: **Donald Blimline, R.R. 11, Box 765, Lenhartsville, Pa. 19534-9633**
- [\*\*] Term: **14 Years**
- [21] Appl. No.: **563,976**
- [22] Filed: **Aug. 7, 1990**
- [52] U.S. Cl. .... **D21/28; D10/46.1; D19/42; D19/78**
- [58] Field of Search ..... **D21/14-36, D21/48, 57; 273/236-285, 148 R; D10/46.1; D19/2, 36, 42, 78**

4,735,415 4/1988 Corn .

### OTHER PUBLICATIONS

Famous Parker Games 1958 p. 25 Baseball, Football, & Checkers, Bottom.

*Primary Examiner*—Bernard Ansher  
*Assistant Examiner*—Sandra Morris  
*Attorney, Agent, or Firm*—Terry M. Gernstein

### [56] References Cited U.S. PATENT DOCUMENTS

D. 47,473	6/1915	Reitler	.....	D19/42
D. 47,852	9/1915	Kulow	.....	D19/42
D. 128,625	8/1941	Fischer	.....	D3/62
D. 155,152	9/1949	Greenstein et al.	.....	D19/42
D. 282,125	1/1986	Alonzo	.....	D21/28
D. 292,969	12/1987	Love	.....	D21/28
772,344	10/1904	Dupeire	.....	D21/28
2,131,825	10/1938	Sultzer	.....	D21/29
2,359,253	9/1944	Silano	.....	D21/28
4,230,316	10/1980	Harper	.....	
4,331,425	5/1982	Davis, Jr.	.....	D10/46.1
4,687,199	8/1987	Aguirregomezcorta	.....	

### [57] CLAIM

The ornamental design for a combined baseball game, score pad and pen, as shown and described.

### DESCRIPTION

FIG. 1 is a top perspective view of the combined baseball game, score pad, and pen, showing my new design, the pen shown removed from clarity;

FIG. 2 is a plan view of the inside of the cover, the score pad shown removed for clarity;

FIG. 3 is a right side elevational view thereof, the left side being plain and unornamented;

FIG. 4 is a bottom plan view thereof;

FIG. 5 is an edge elevational view thereof, the cover shown open for clarity;

FIG. 6 is a perspective view of the scoring pen; and,

FIG. 7 is a top plan view of the score pad, having a multiplicity of leaves, the bottom being plain and unornamented.

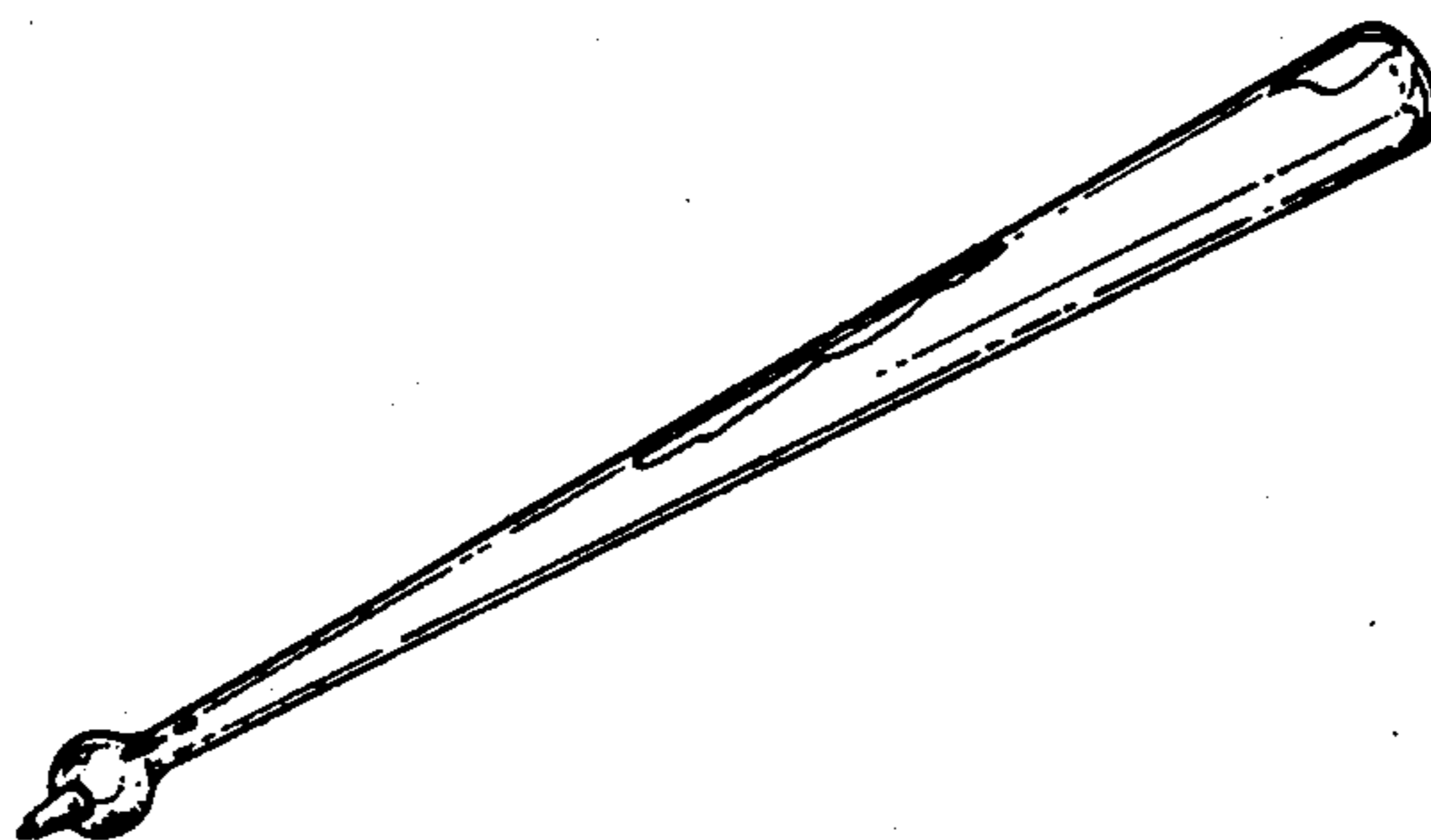
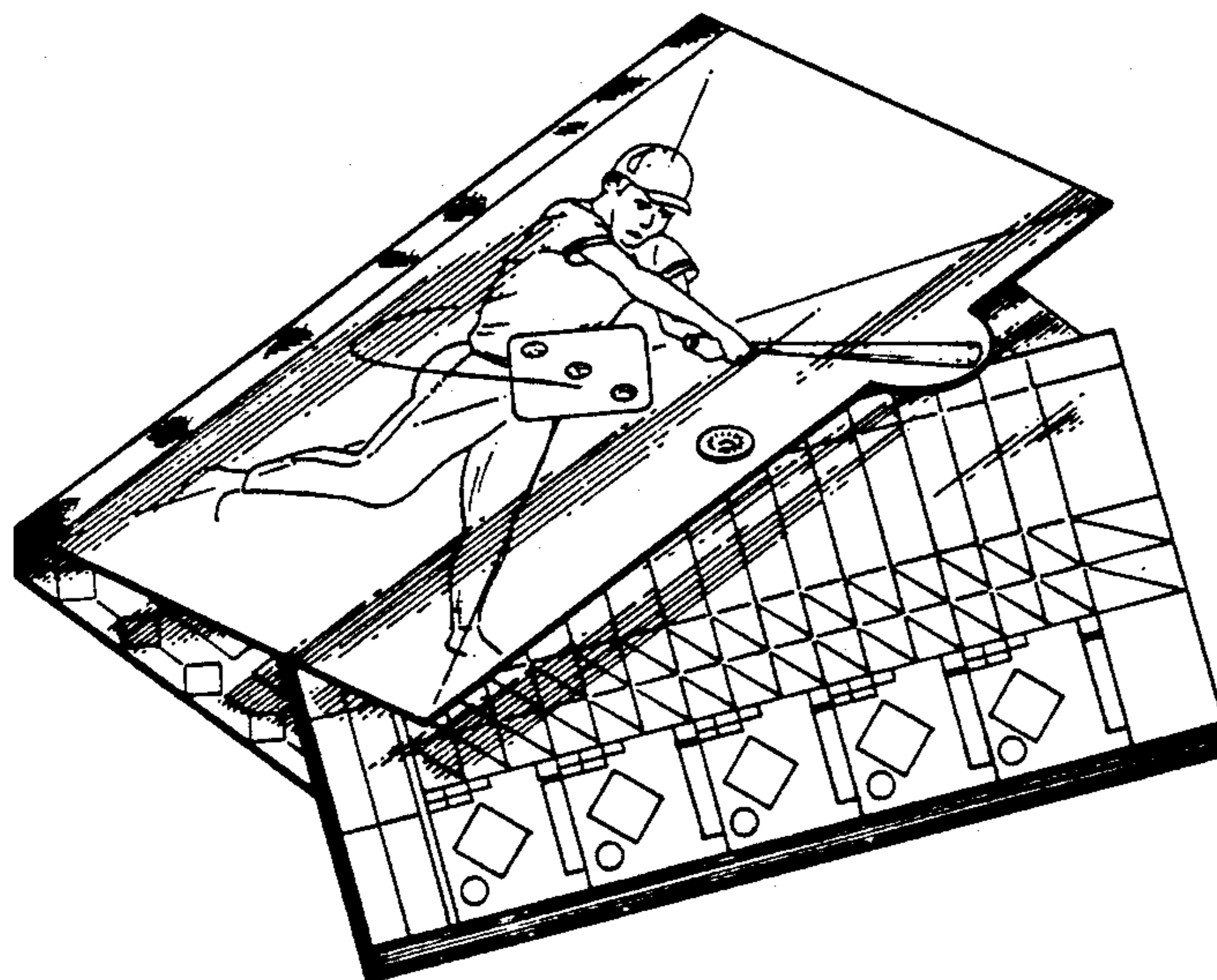

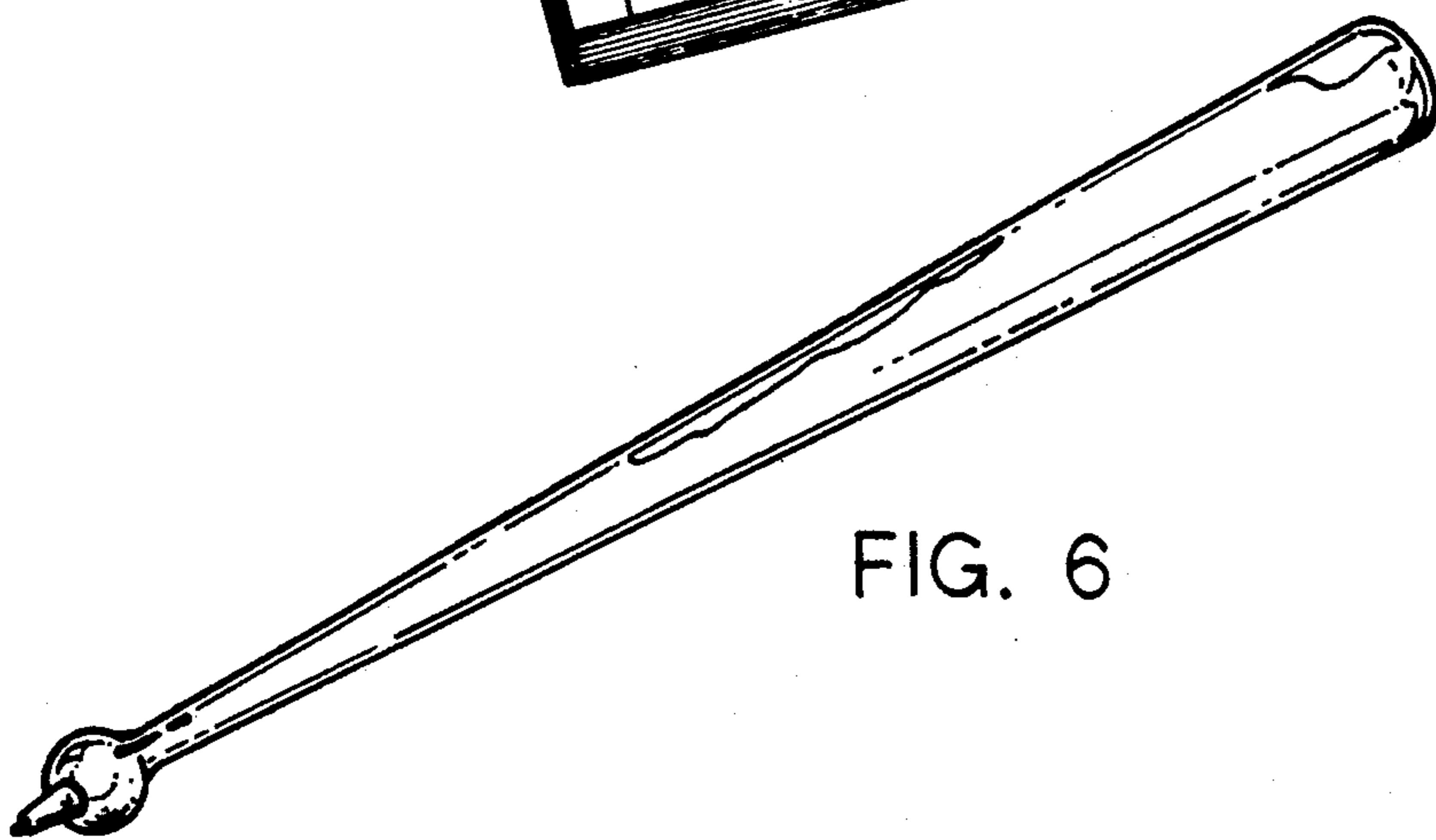
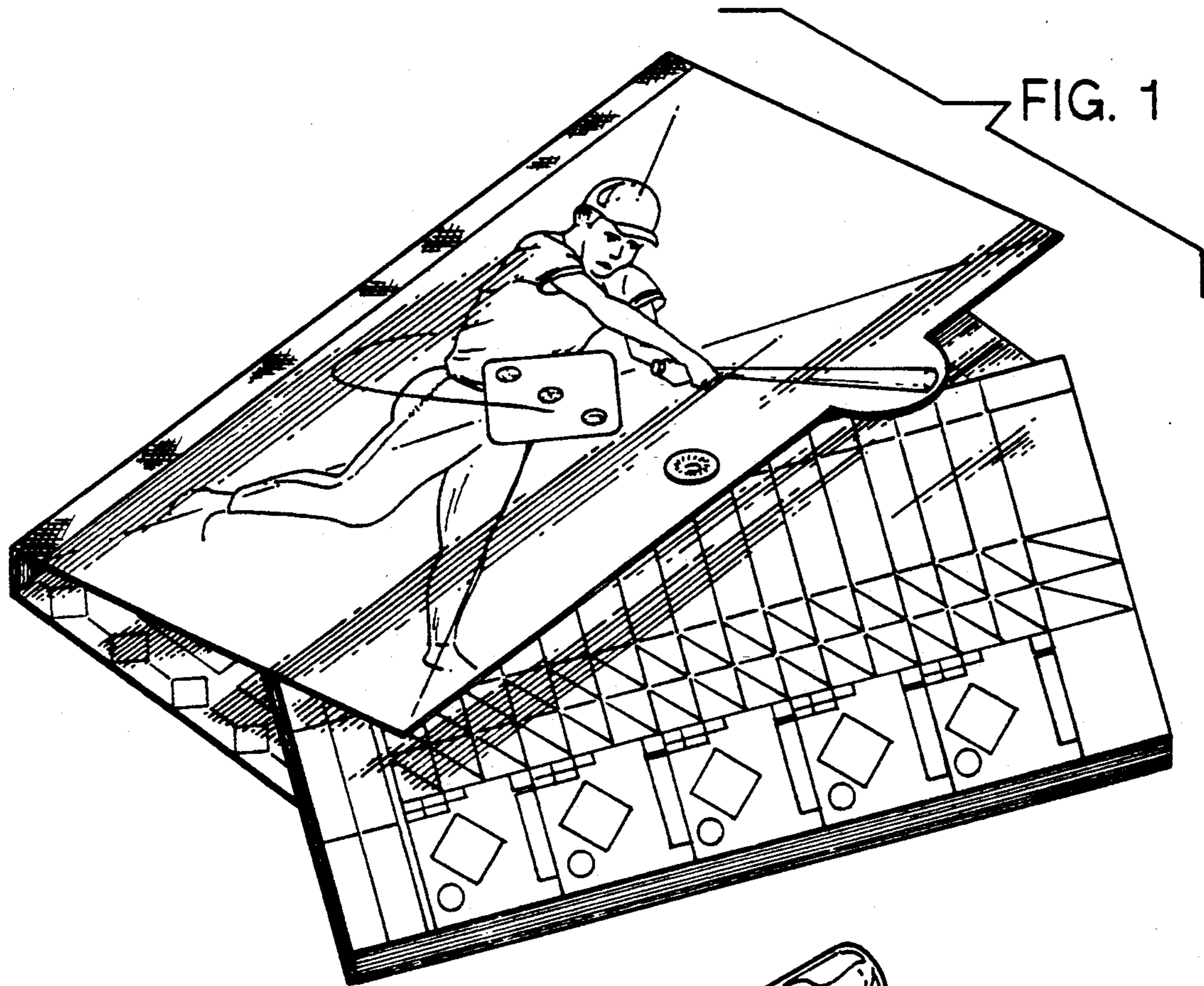

FIG. 6

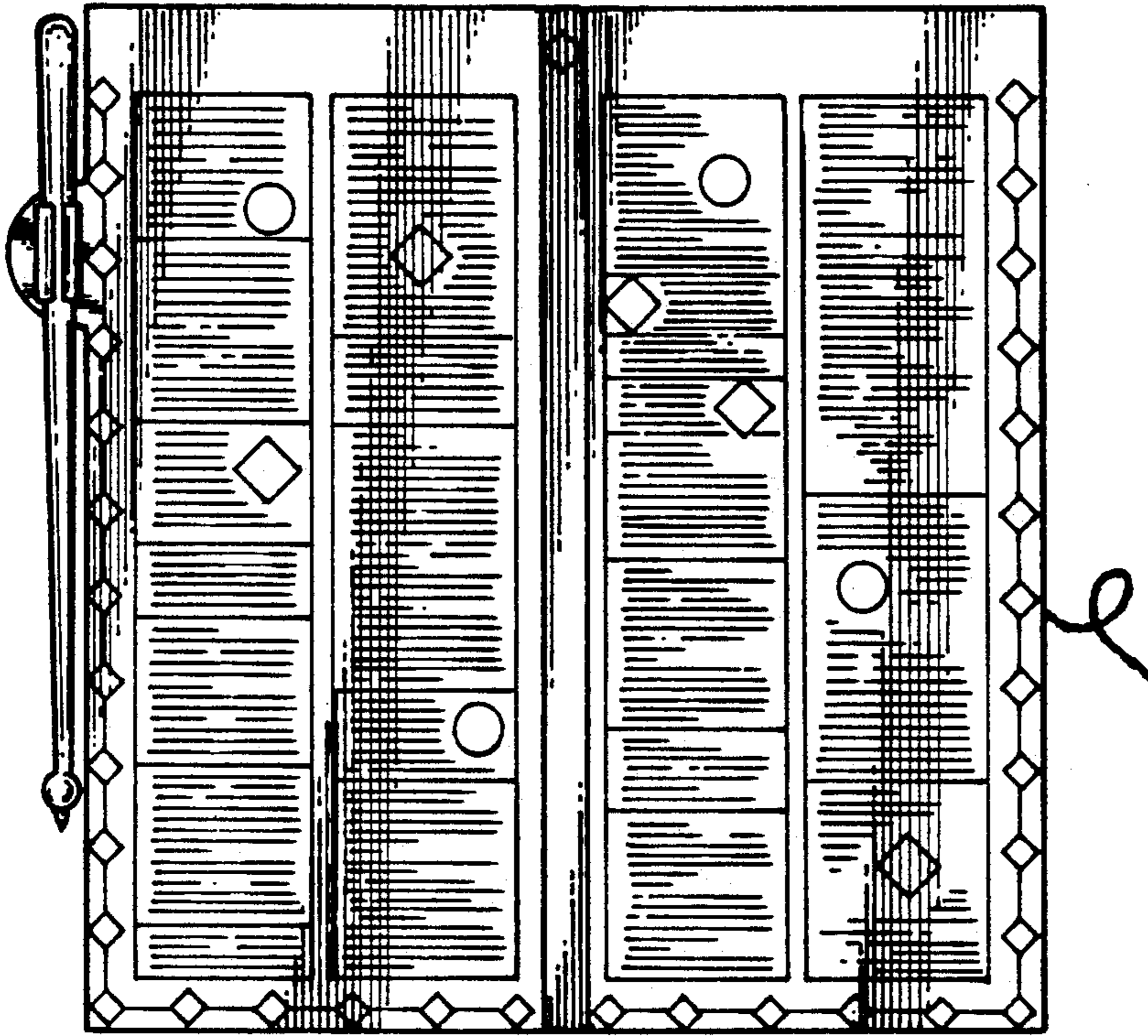

FIG. 2



FIG. 3

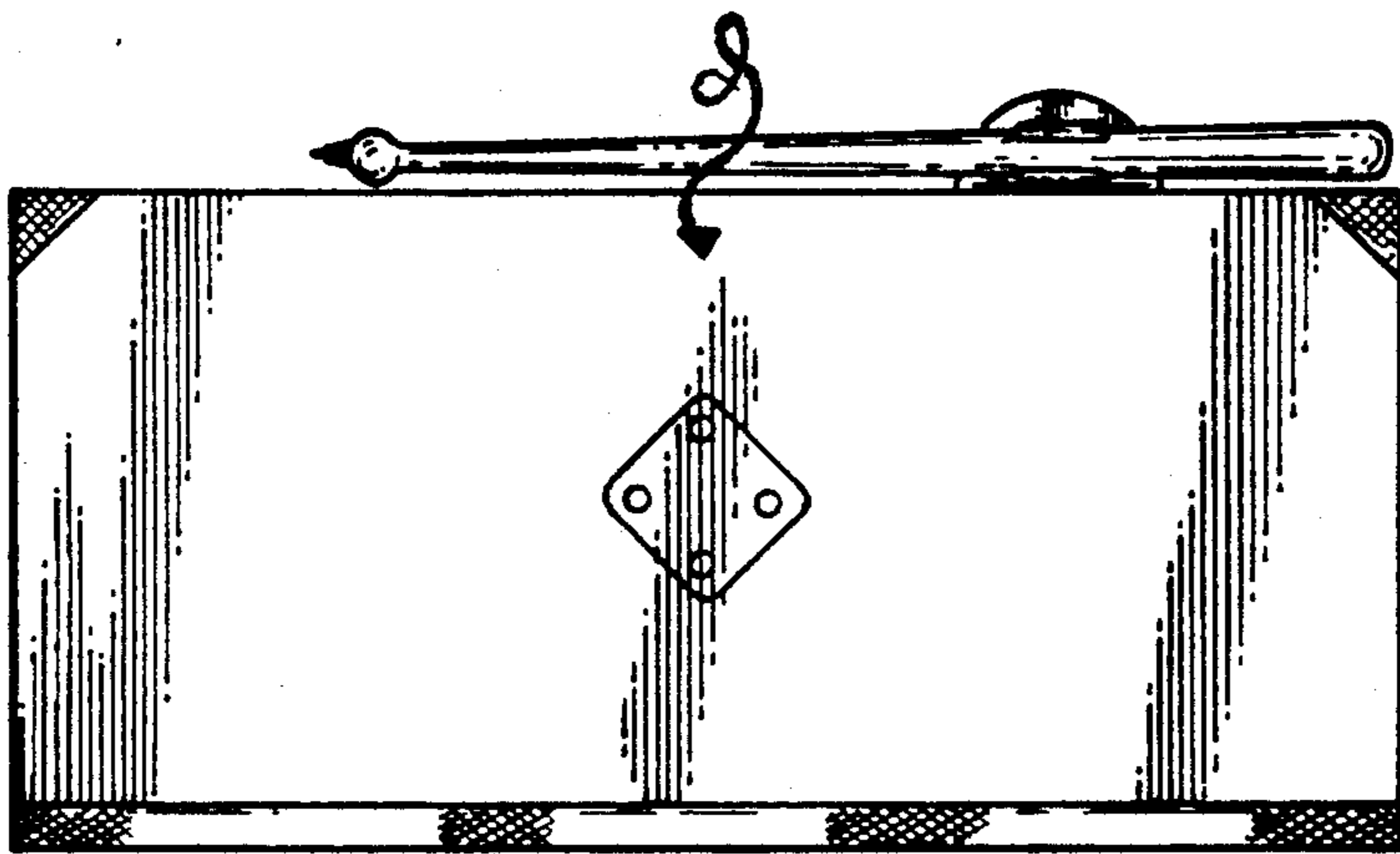

FIG. 4

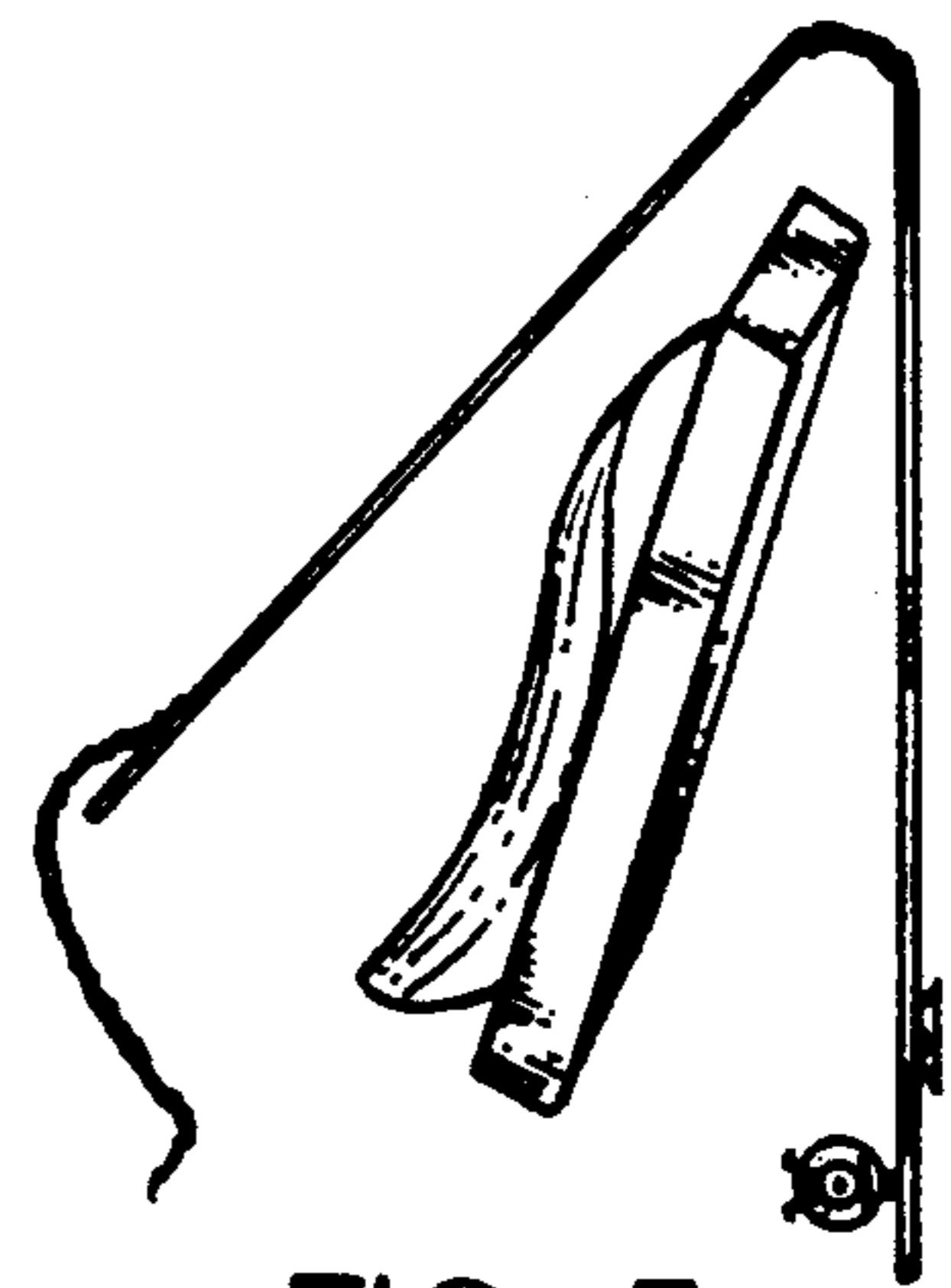

FIG. 5

FIG. 7

