



US00D332799S

United States Patent [19]

Goodrich et al.

[11] Patent Number: Des. 332,799

[45] Date of Patent: ** Jan. 26, 1993

[54] **DESKTOP ELECTROPHOTOGRAPHIC PRINTER**

[75] Inventors: Donald S. Goodrich, The Woodlands; Steven D. Gluskoter, Houston; Randall W. Martin, The Woodlands, all of Tex.

[73] Assignee: Compaq Computer Corporation, Houston, Tex.

[**] Term: 14 Years

[21] Appl. No.: 870,182

[22] Filed: Apr. 6, 1992

Related U.S. Application Data

- [63] Continuation of Ser. No. 636,968, Dec. 31, 1990, abandoned.
- [52] U.S. Cl. D18/55
- [58] Field of Search 101/9, 18, 21, 28-29, 101/41-42, 130, 316, 287, 420; 400/691-694, 613, 613.1, 613.4, 624; D18/50, 53-55, 36-37; D14/118

References Cited

U.S. PATENT DOCUMENTS

- D. 281,256 11/1985 Yamamoto D18/37
- D. 284,006 5/1986 Freijd D18/55
- D. 291,095 7/1987 Morozumi et al. D18/55
- D. 293,247 12/1987 Nakade D18/55
- D. 305,774 1/1990 Yomo D18/55
- D. 306,744 3/1990 Yomo D18/55

- D. 307,764 5/1990 Kojima D18/55
- D. 308,219 5/1990 Yoshida D18/36
- D. 308,695 6/1990 Eto et al. D18/55

FOREIGN PATENT DOCUMENTS

- 5928017 12/1986 Japan D18/55
- 5940889 12/1986 Japan D18/55
- 6135358 7/1988 Japan D18/55
- 6014682 1/1989 Japan D18/55

OTHER PUBLICATIONS

Genicom 5010 Laser Printer Brochure; p. 5.
Canon LBP-8II Laser Beam Printer; Cover Page, 1987.

Primary Examiner—A. Hugo Word
Assistant Examiner—Cathy Anne MacCormac
Attorney, Agent, or Firm—Irene Kosturakis; David Cabello; Jim Burdett

[57] CLAIM

The ornamental design for a desktop electrophotographic printer, as shown and described.

DESCRIPTION

FIG. 1 is top, front, left side perspective view of a desktop electrophotographic printer showing our new design;
FIG. 2 is a front elevational view thereof;
FIG. 3 is a right side elevational view thereof;
FIG. 4 is a rear elevational view thereof;
FIG. 5 is a left side elevational view thereof, the bottom being plain and unornamented and,
FIG. 6 is a top plan view thereof.

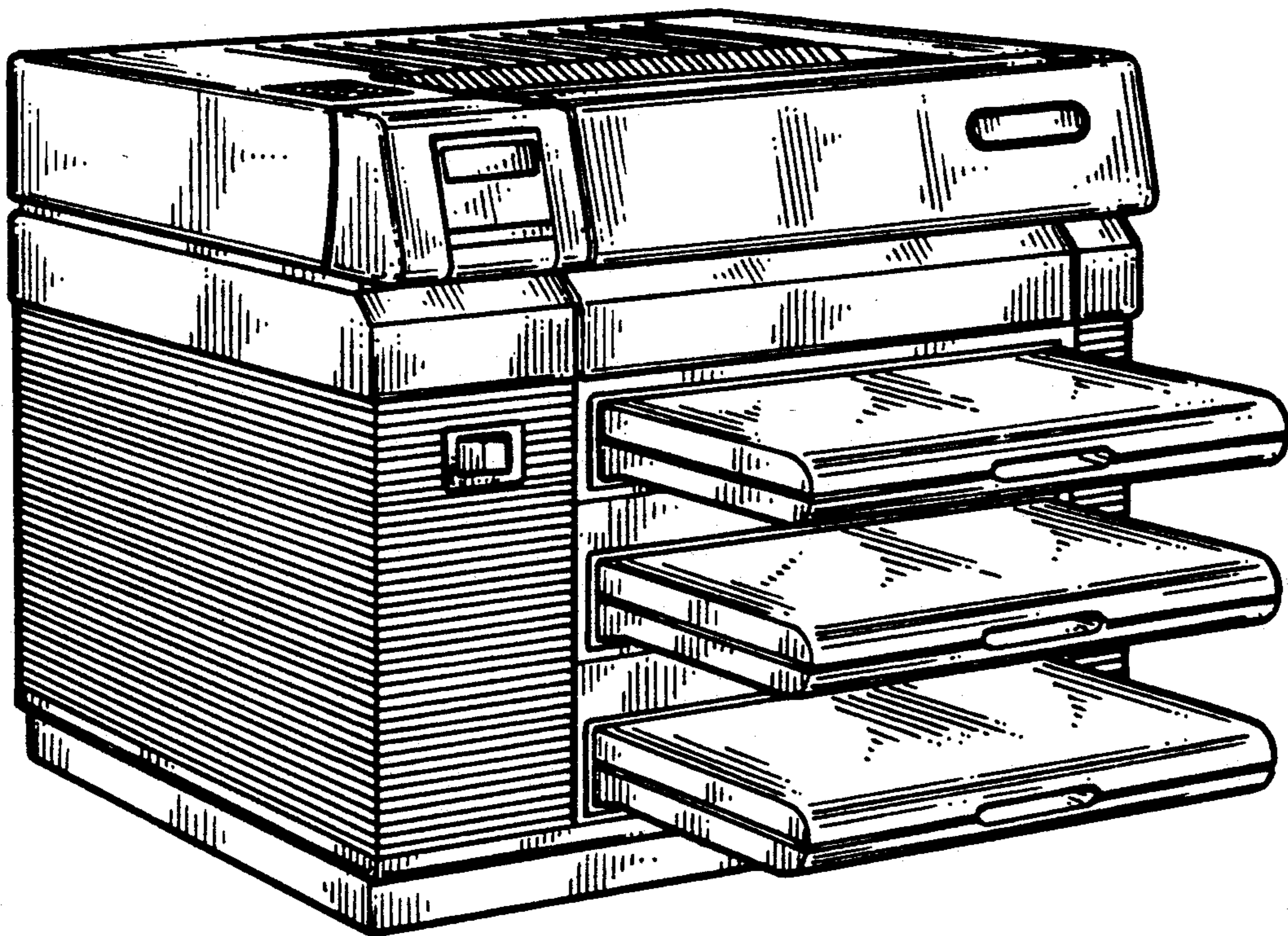

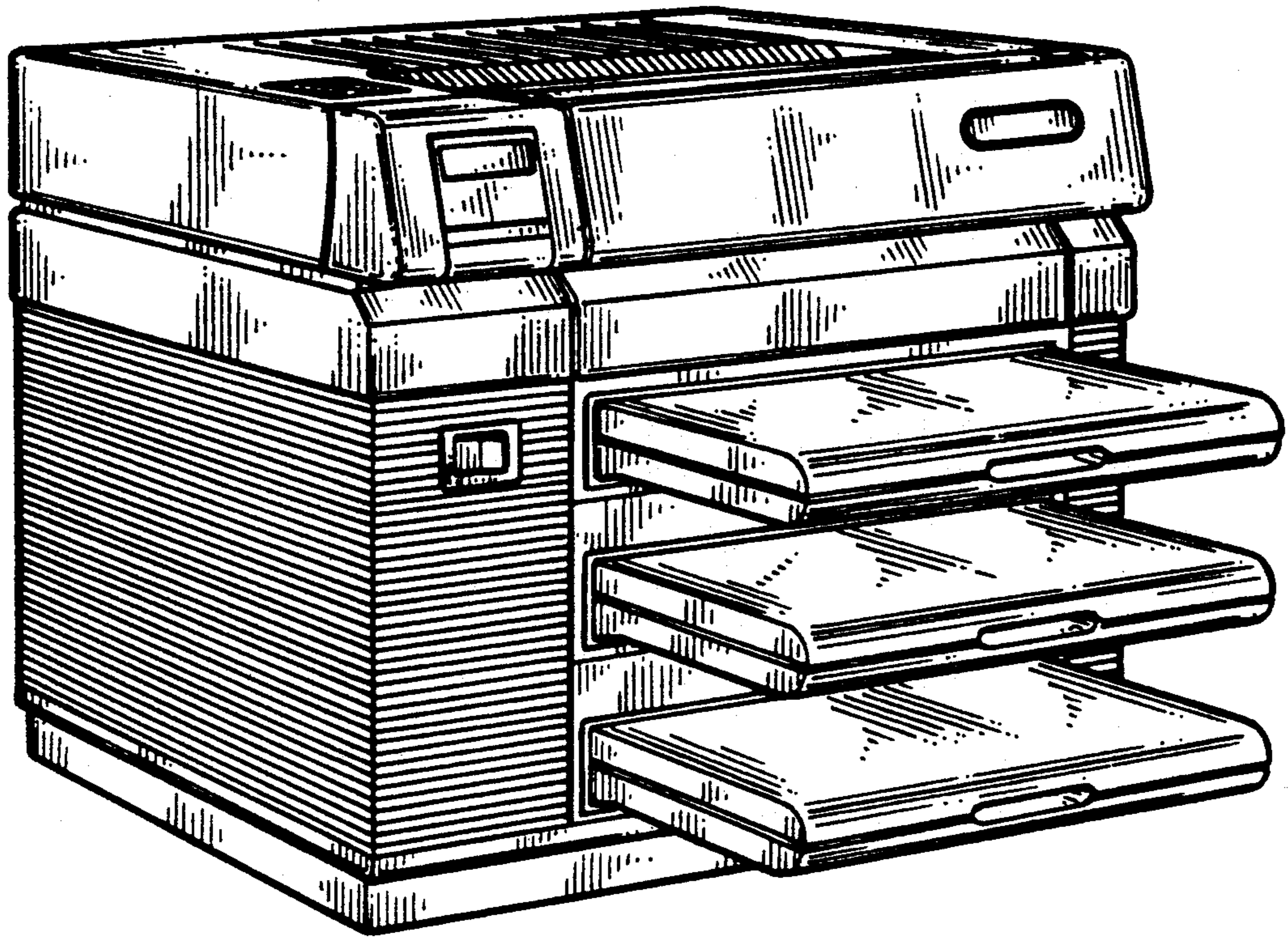

FIG. 1

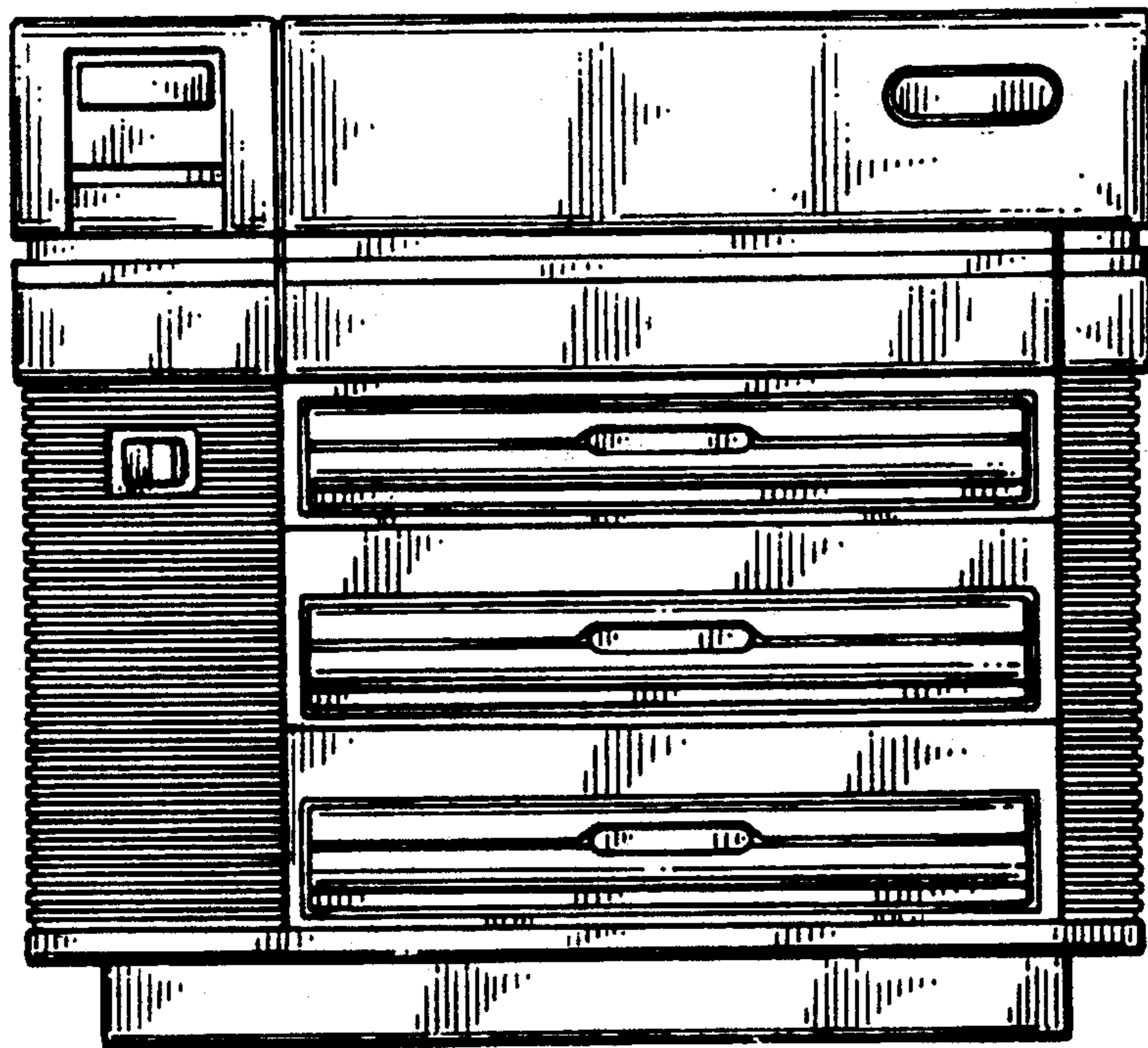

FIG. 2

FIG.3

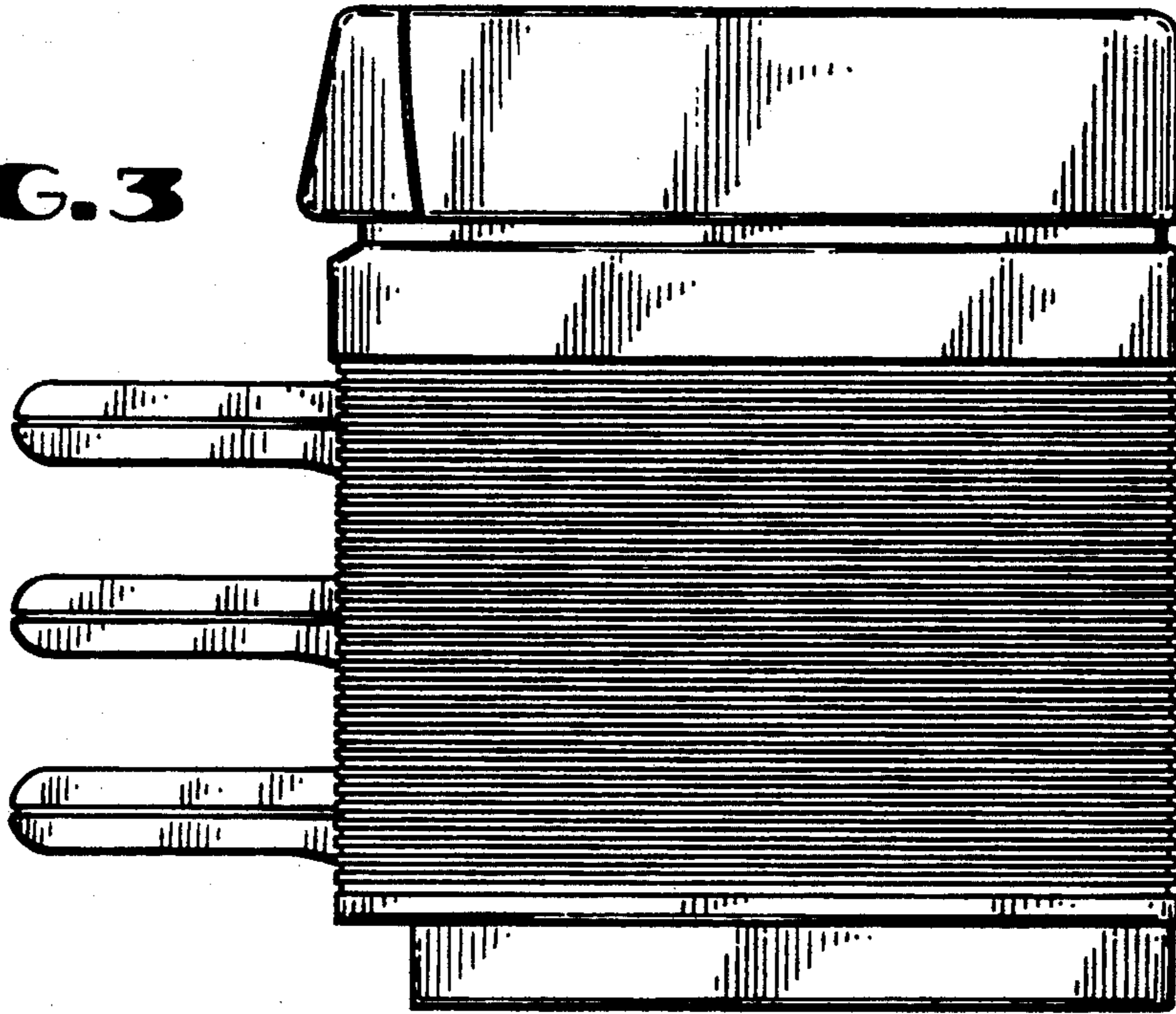
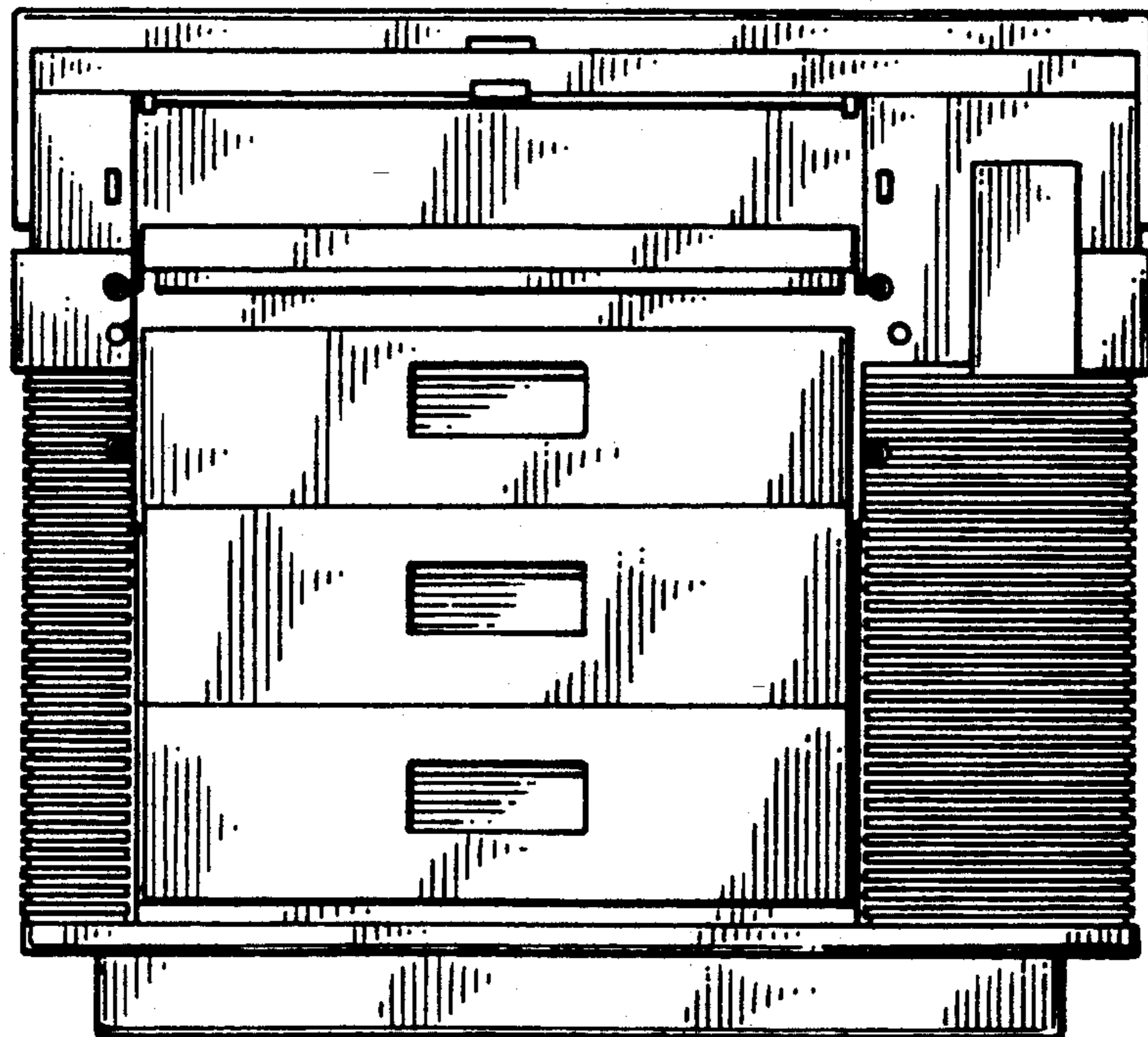

FIG.4



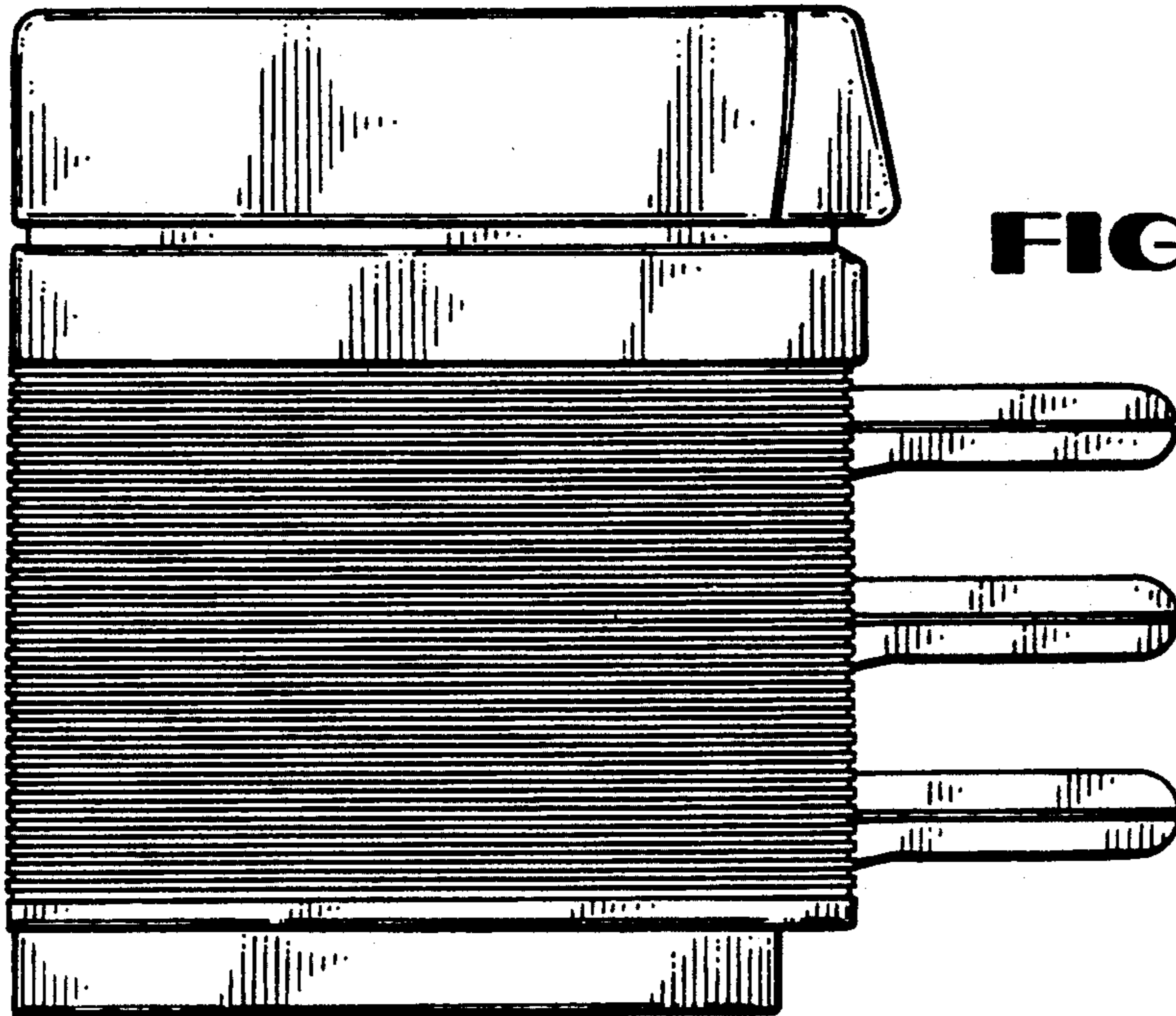

FIG. 5

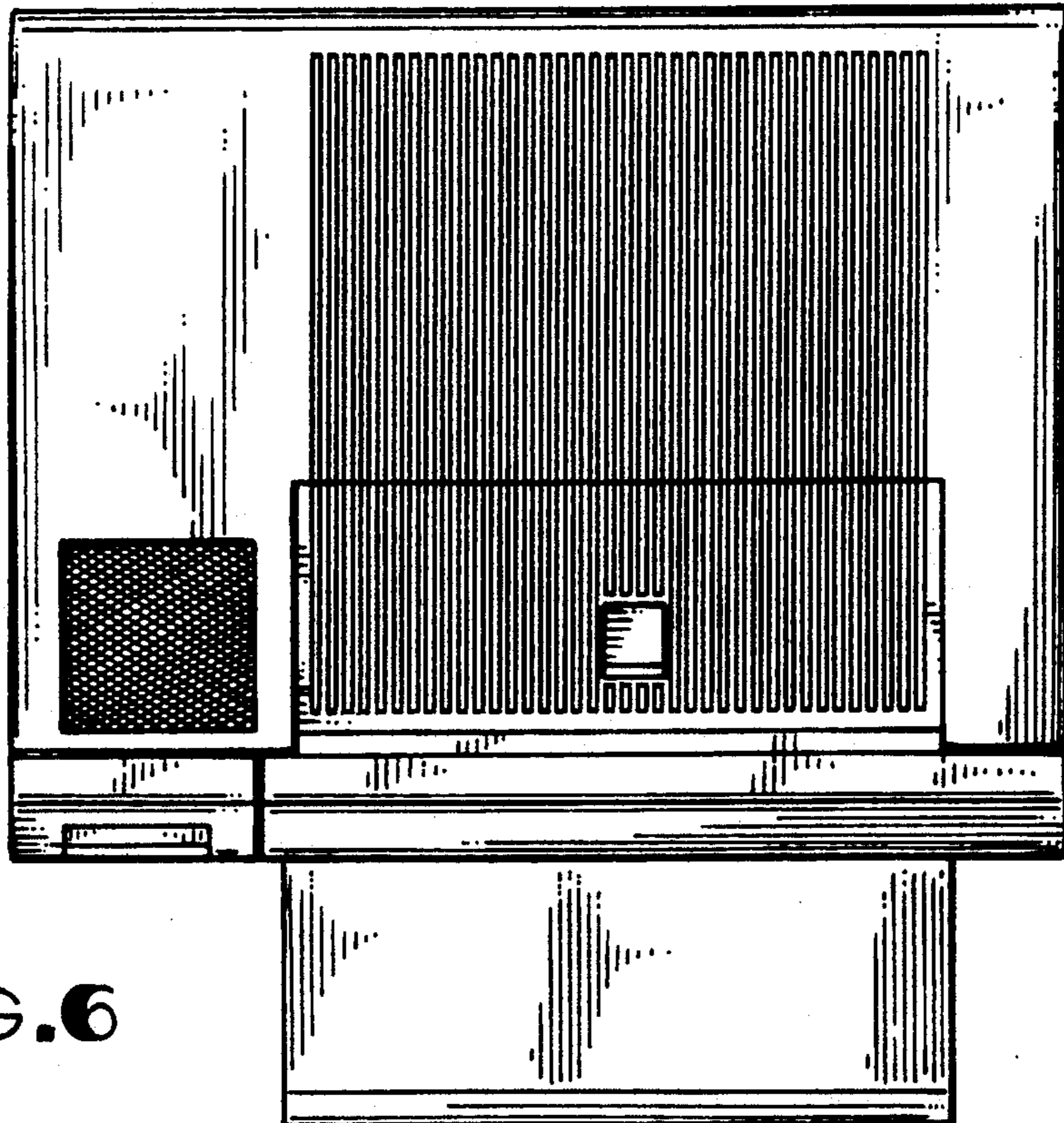

FIG. 6