



US00D332744S

United States Patent [19]
McCoey

[11] **Patent Number: Des. 332,744**

[45] **Date of Patent: ** Jan. 26, 1993**

[54] **PACKAGE FOR WALLPAPER**

[75] Inventor: **Michael J. McCoey, Hudson, Ohio**

[73] Assignee: **Imperial Wall Coverings, Inc.,
Cleveland, Ohio**

[**] Term: **14 Years**

[21] Appl. No.: **617,054**

[22] Filed: **Nov. 20, 1990**

[52] U.S. Cl. **D9/415; D9/341;
D9/418**

[58] Field of Search **D9/418, 432, 424, 341,
D9/337; 206/45.31, 45.34, 45.33, 45.19, 303,
388, 49, 391, 398, 410**

[56] **References Cited**

U.S. PATENT DOCUMENTS

D. 211,321	6/1968	Ullmann	D9/418
D. 227,351	6/1973	Winton	D9/418
D. 244,259	5/1977	Bergstein	D9/418
D. 291,065	7/1987	Pugh	D9/418
2,113,288	4/1938	Berger	206/45.31
3,190,440	6/1965	Palmer	206/45.31
3,249,213	5/1966	Palmer	206/45.31

OTHER PUBLICATIONS

Modern Packaging, 1972-1973, p. 134, box, shown by arrow, bottom left of the page.

Primary Examiner—Bernard Ansher
Assistant Examiner—Prabhakar Deshmukh
Attorney, Agent, or Firm—Bell, Seltzer, Park & Gibson

[57] **CLAIM**

The ornamental design for a package for wallpaper, as shown and described.

DESCRIPTION

FIG. 1 is a perspective view of a package for wall paper showing my new design;

FIG. 2 is a front elevational view thereof;

FIG. 3 is a top plan view thereof; the bottom plan view being a mirror image thereof;

FIG. 4 is a right side elevational view thereof; undisclosed in FIG. 1;

FIG. 5 is a sectional plan view thereof; taken along line 5-5 of FIG. 1; and,

FIG. 6 is a sectional plan view thereof; taken along line 6-6 of FIG. 1.

The rear elevational view is plain and unornamented.

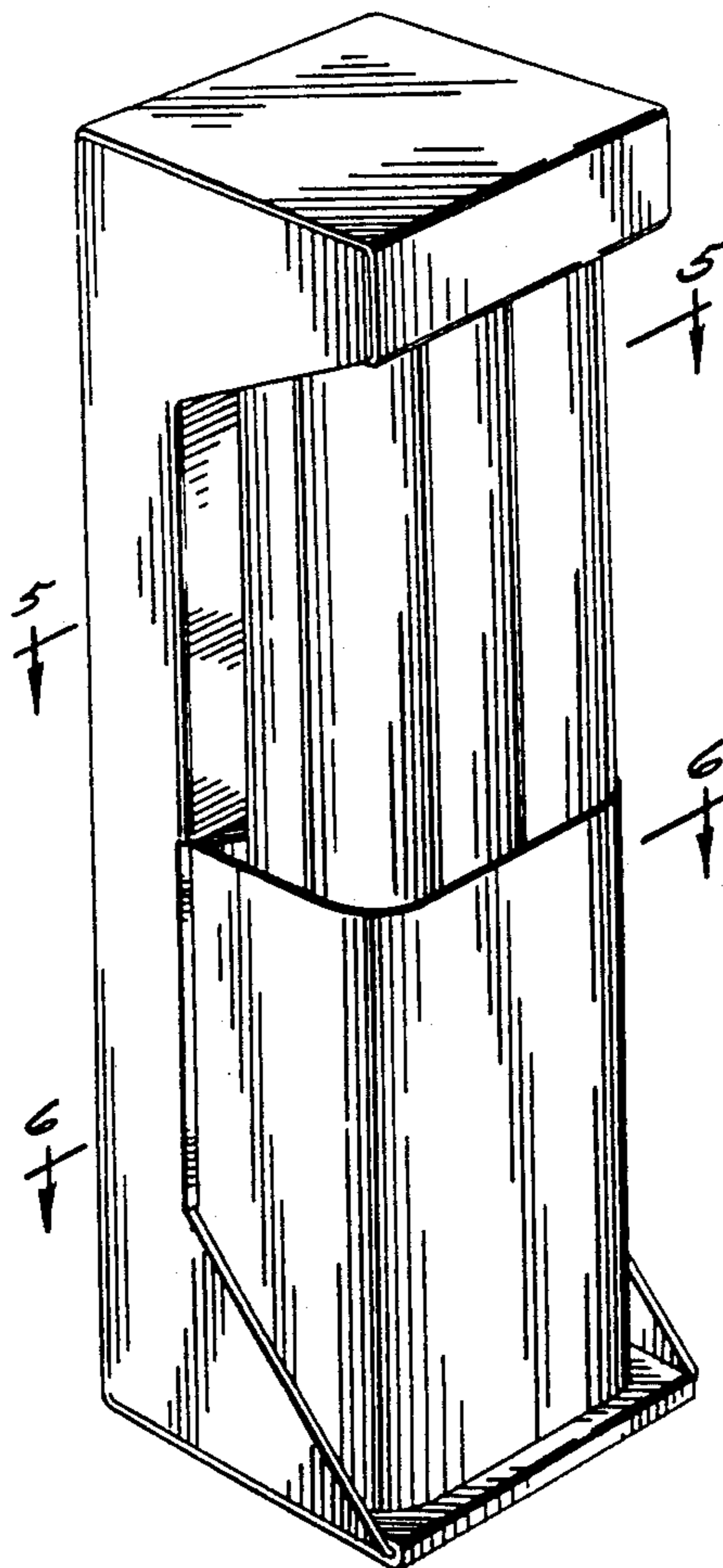

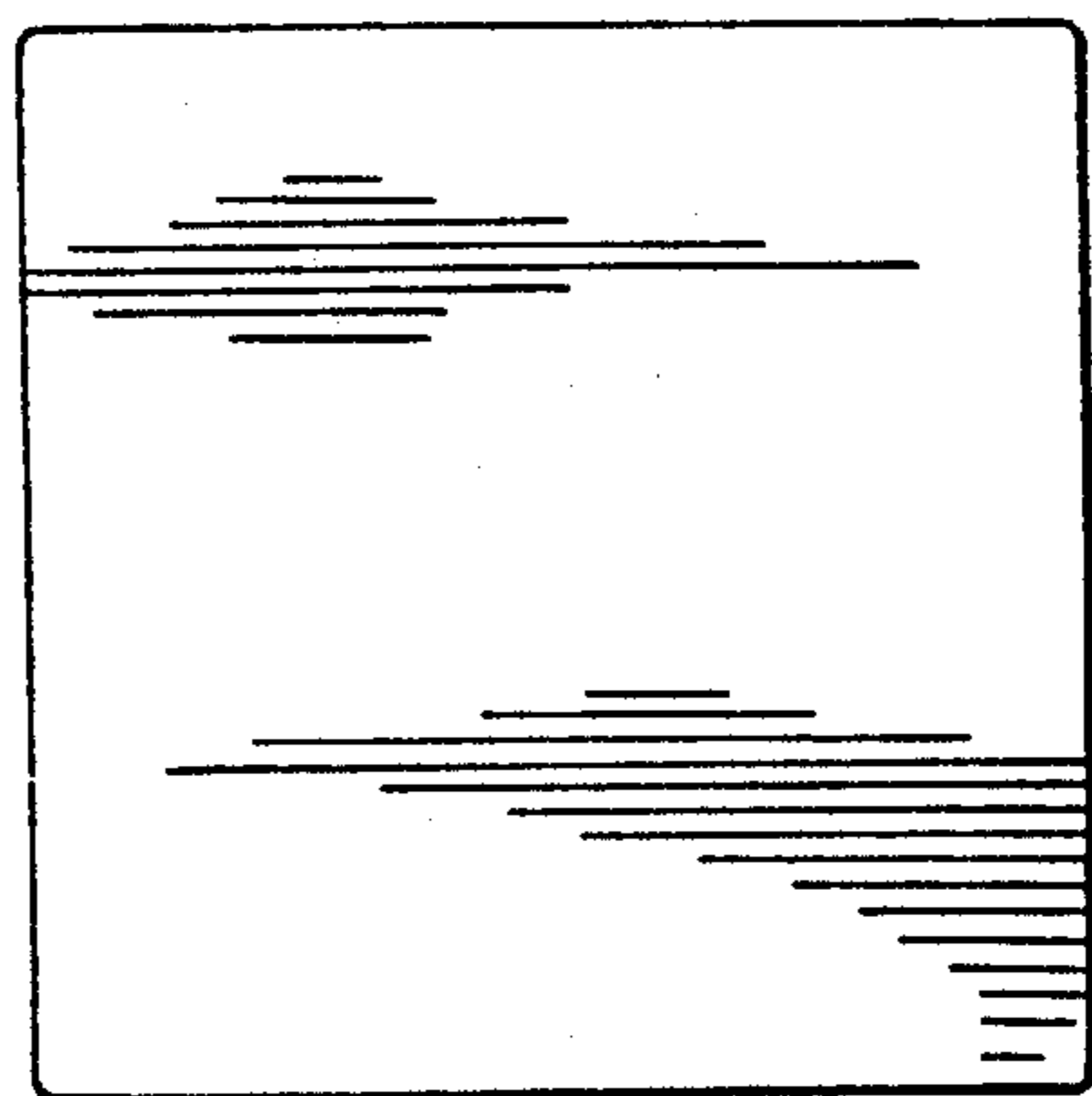
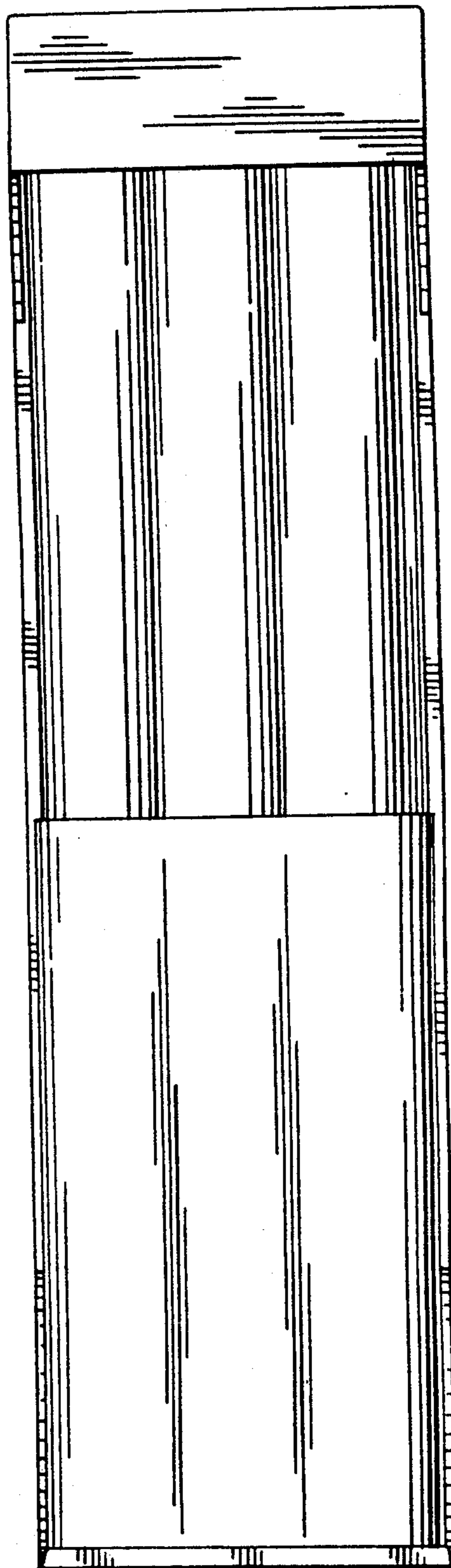
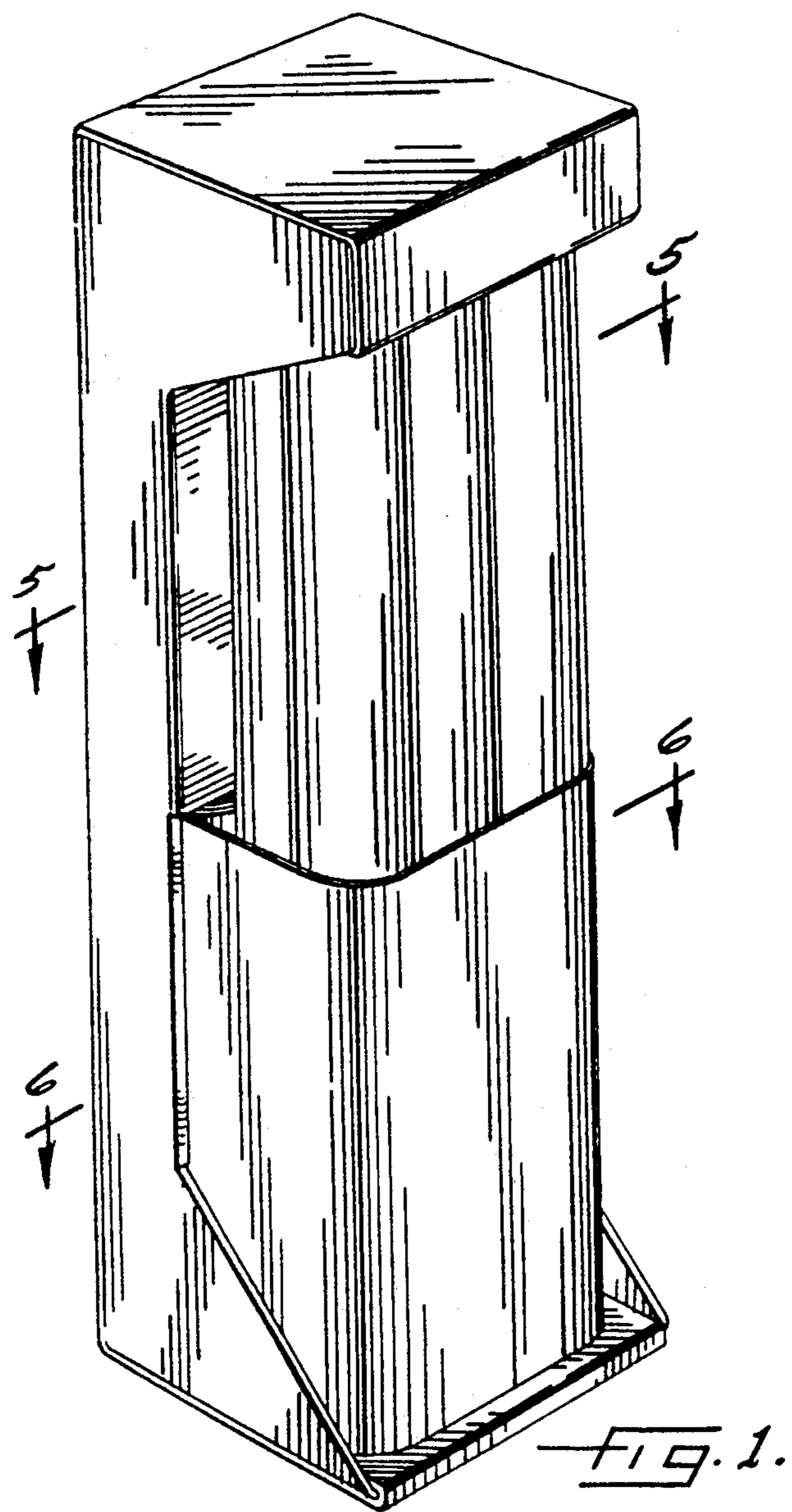

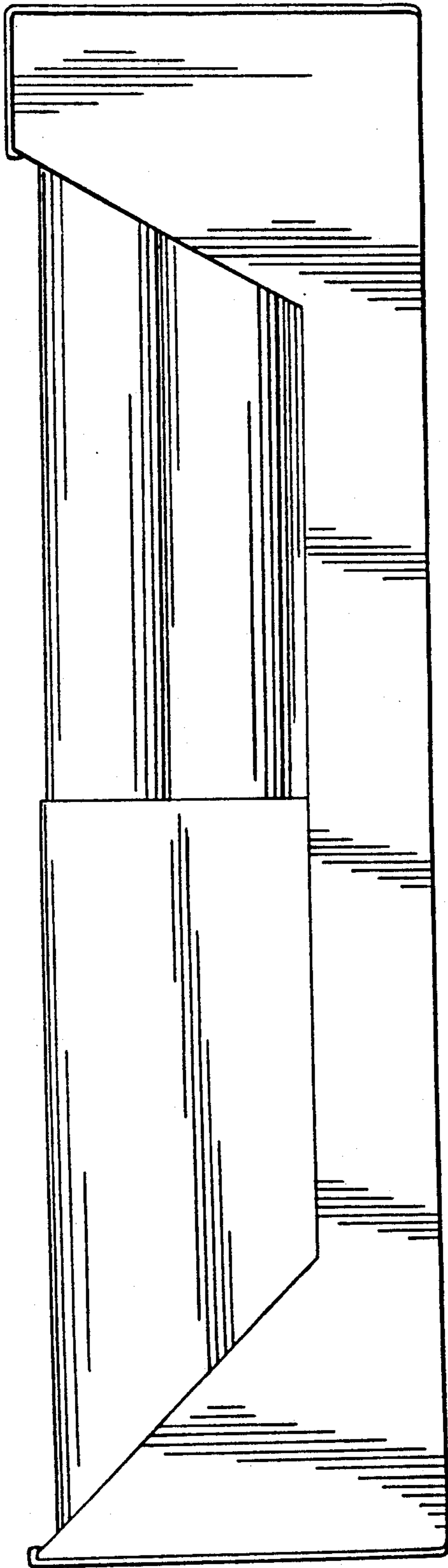

—FIG. 4.

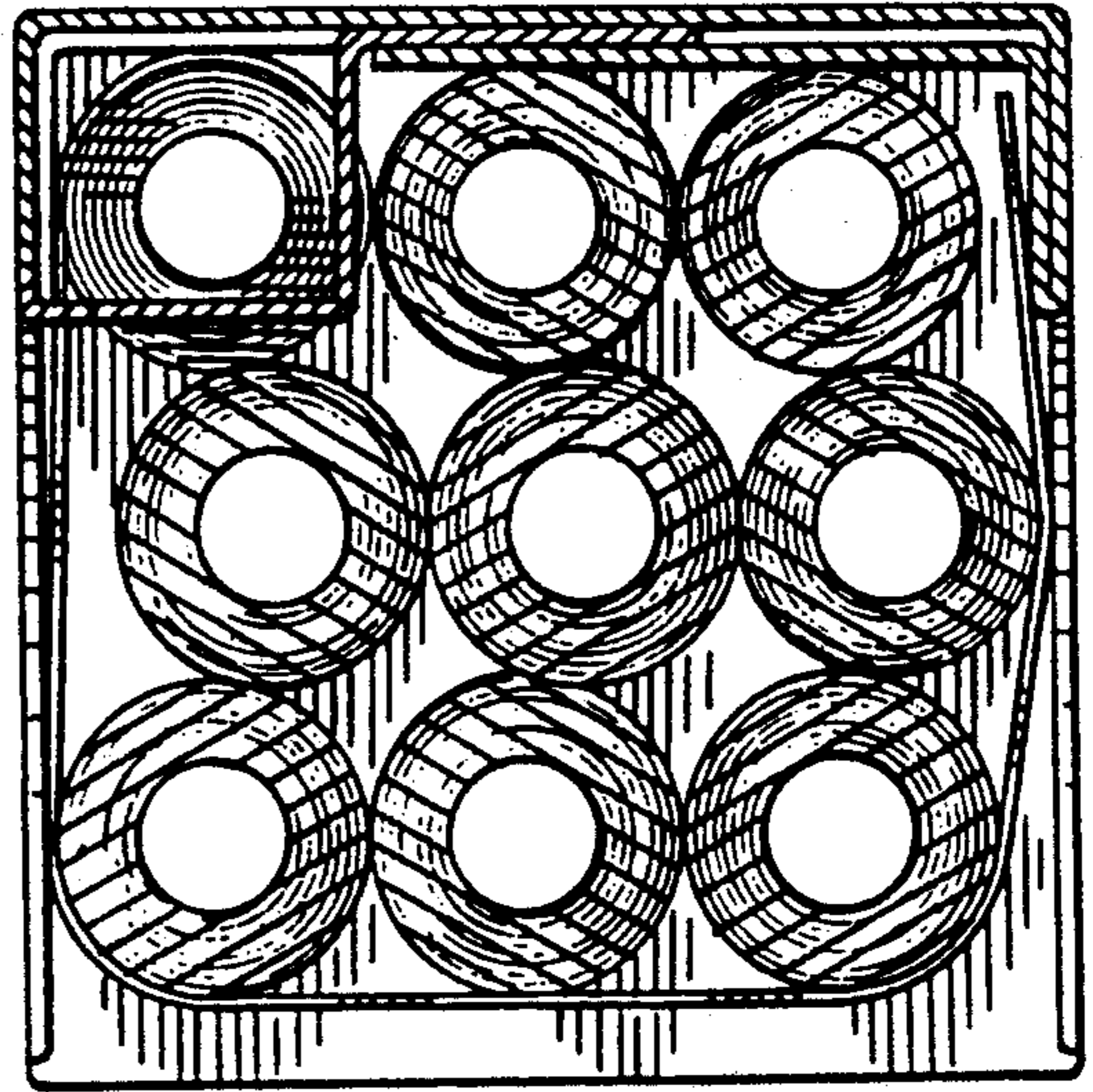

—FIG. 5.

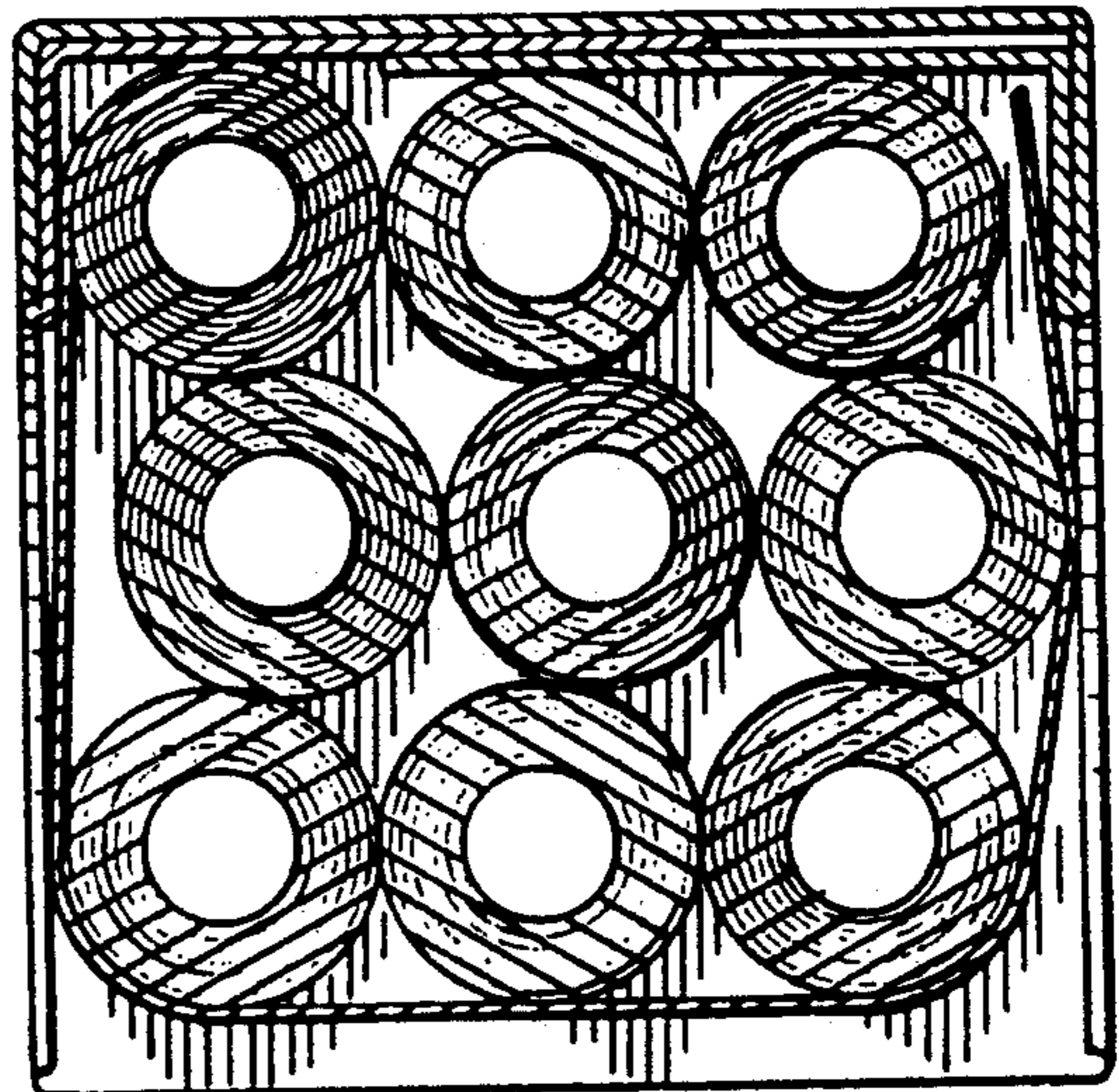

—FIG. 6.