



US00D332568S

United States Patent [19]
Ozawa

[11] **Patent Number: Des. 332,568**
[45] **Date of Patent: ** Jan. 19, 1993**

[54] **LOCK NUT**

[76] **Inventor: Kunihiko Ozawa, 39-6 Tsurukawa
4-chome, Machida-shi, Tokyo, Japan**

[**] **Term: 14 Years**

[21] **Appl. No.: 472,575**

[22] **Filed: Feb. 1, 1990**

[30] **Foreign Application Priority Data**

Nov. 16, 1989 [JP] Japan 1-41685

[52] **U.S. Cl. D8/397**

[58] **Field of Search D8/397, 399; 411/427,
411/917, 918, 955**

[56] **References Cited**

U.S. PATENT DOCUMENTS

2,120,061 6/1938 Blakeslee 411/427
2,679,879 6/1954 Engstrom D8/397

OTHER PUBLICATIONS

Gripco Cat.; p. 2; centerlock nut.
Fastener Standards; fifth ed; ©1965; p. D-12; jam nut
(second from right).

Primary Examiner—B. J. Bullock
Attorney, Agent, or Firm—Jacobson, Price, Holman &
Stern

[57] **CLAIM**

The ornamental design for a lock nut, as shown and
described.

DESCRIPTION

FIG. 1 is a front elevational view of a lock nut showing
my new design; the rear being identical;
FIG. 2 is a side elevational view thereof, not sides
being identical;
FIG. 3 is a top plan view thereof;
FIG. 4 is a bottom plan view thereof;
FIG. 5 is a sectional view taken in the direction of the
arrows on line 5—5 of FIG. 1; and,
FIG. 6 is a sectional view taken in the direction of the
arrows on line 6—6 of FIG. 2.

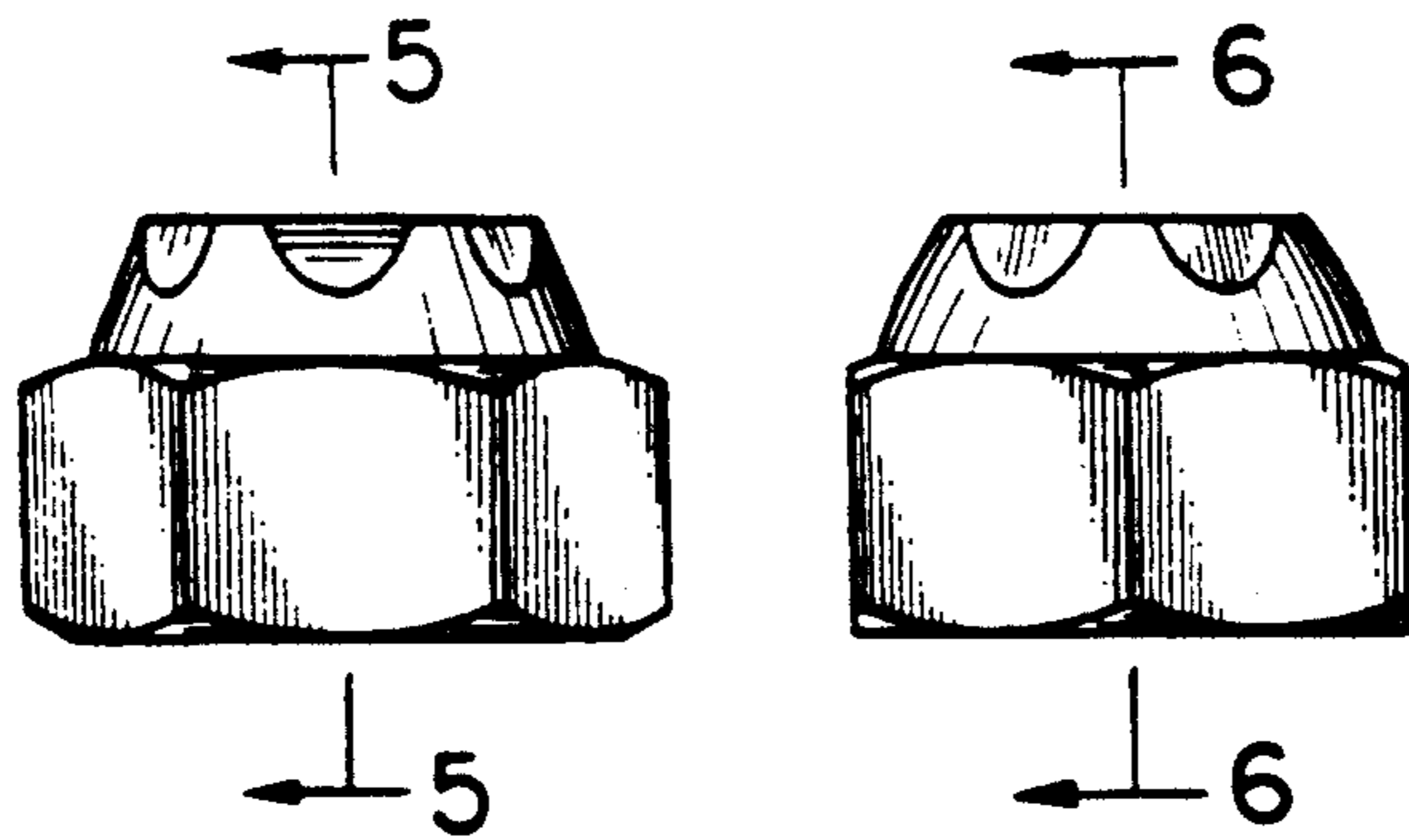

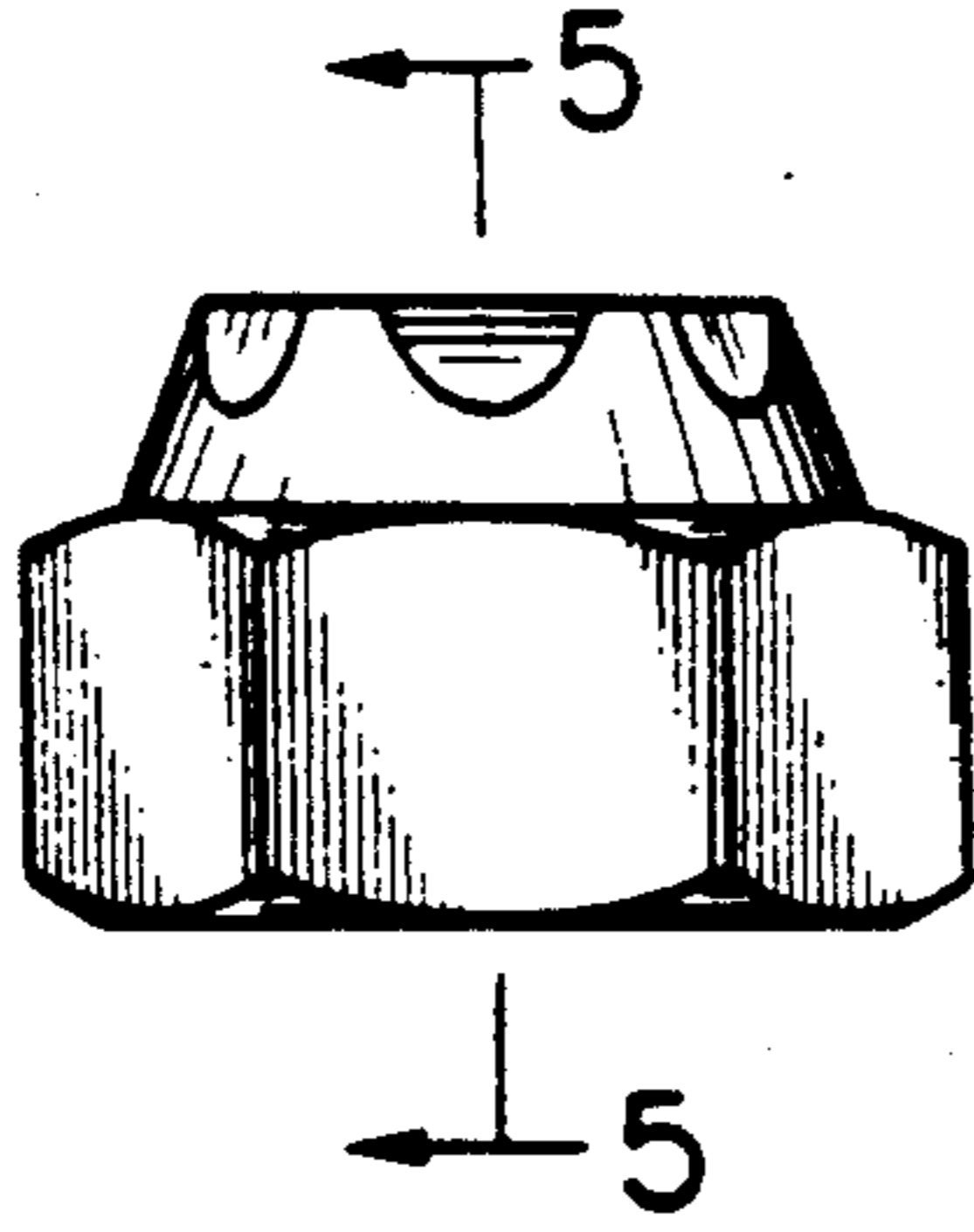

FIG. 1

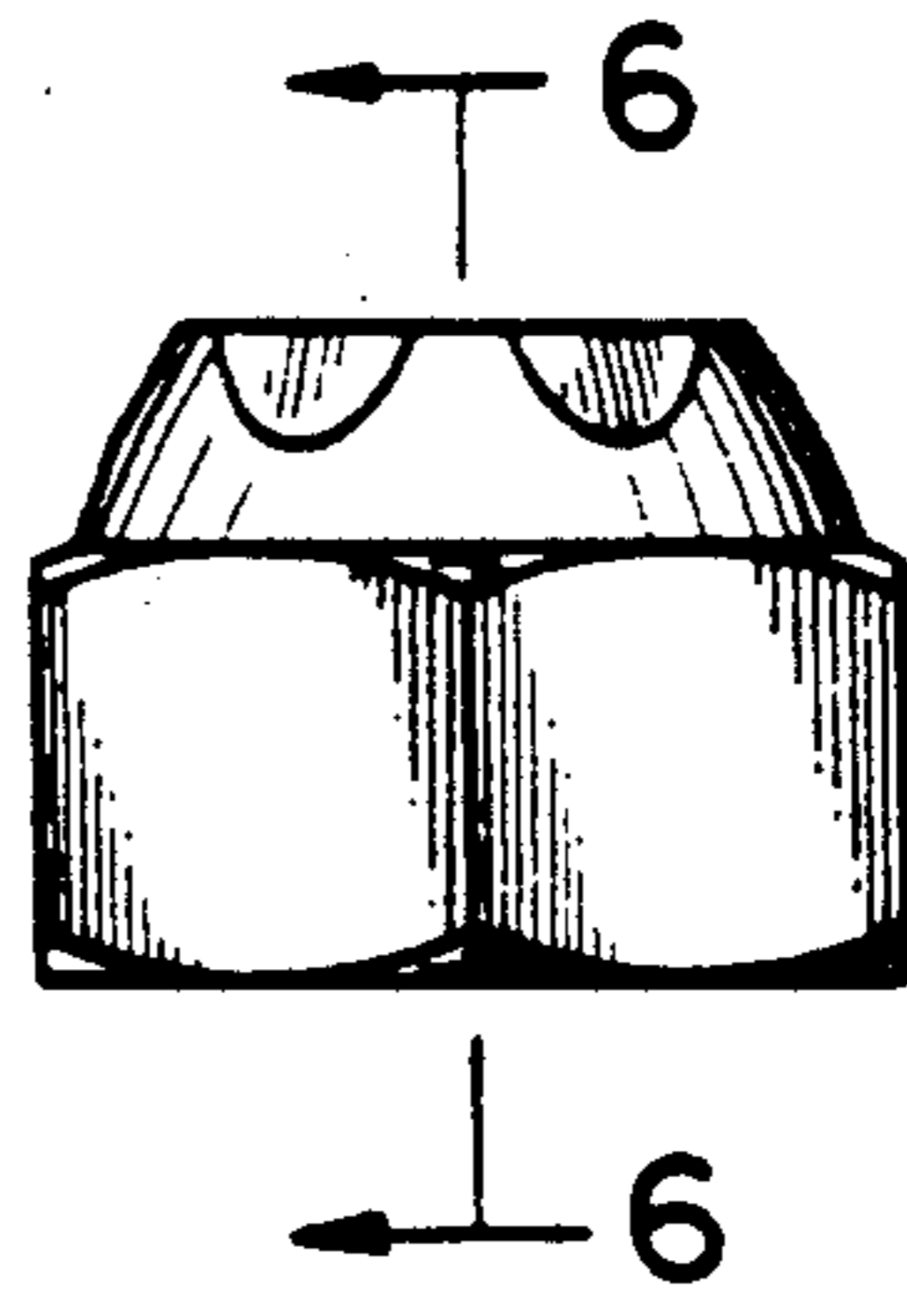

FIG. 2

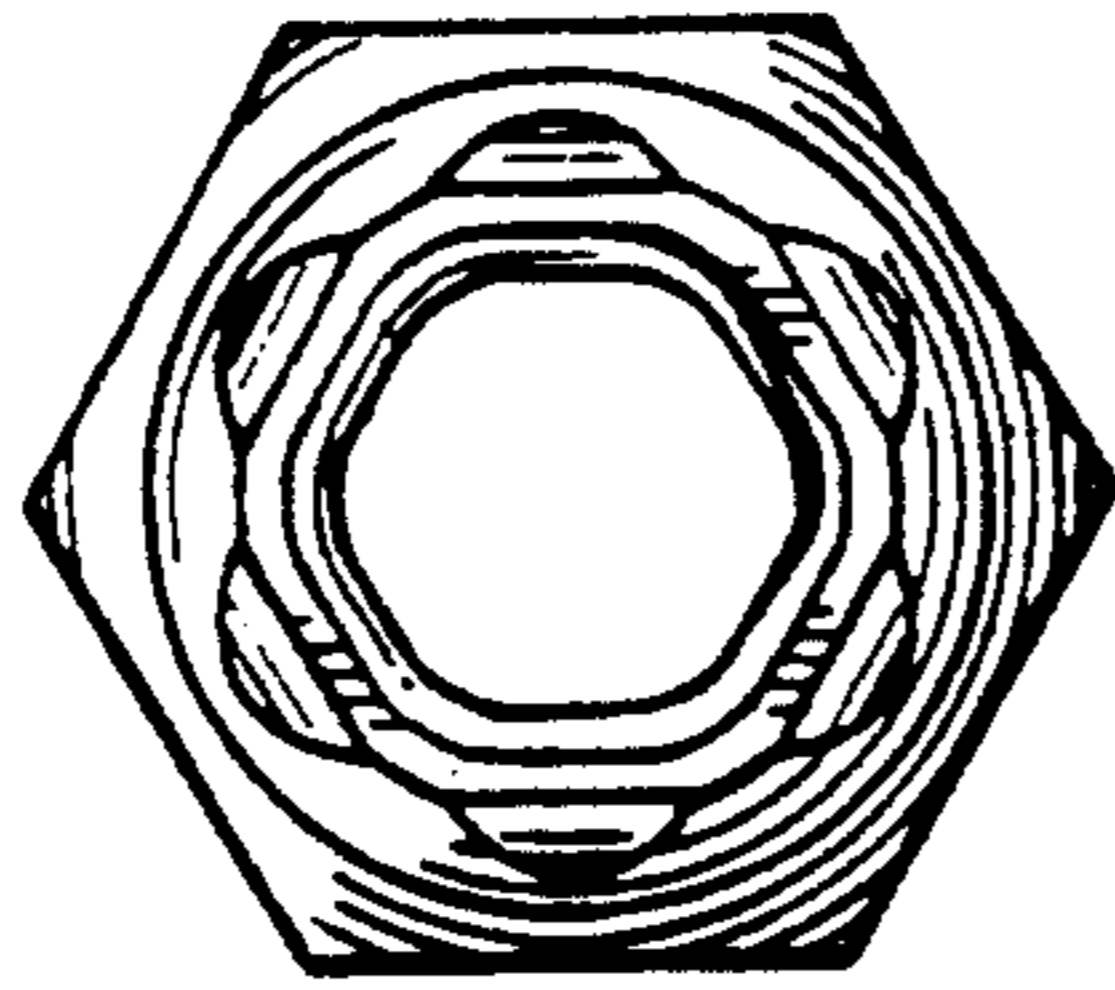

FIG. 3

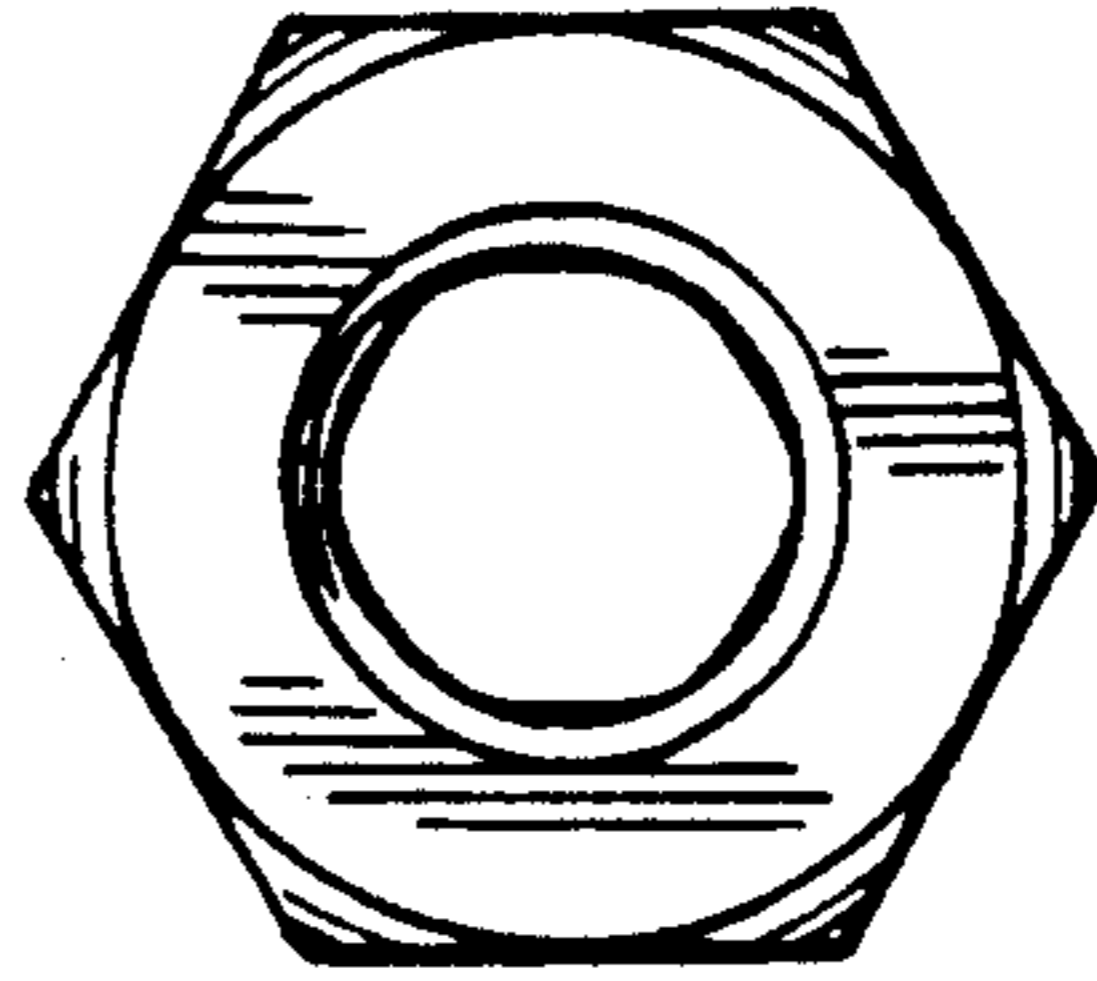

FIG. 4

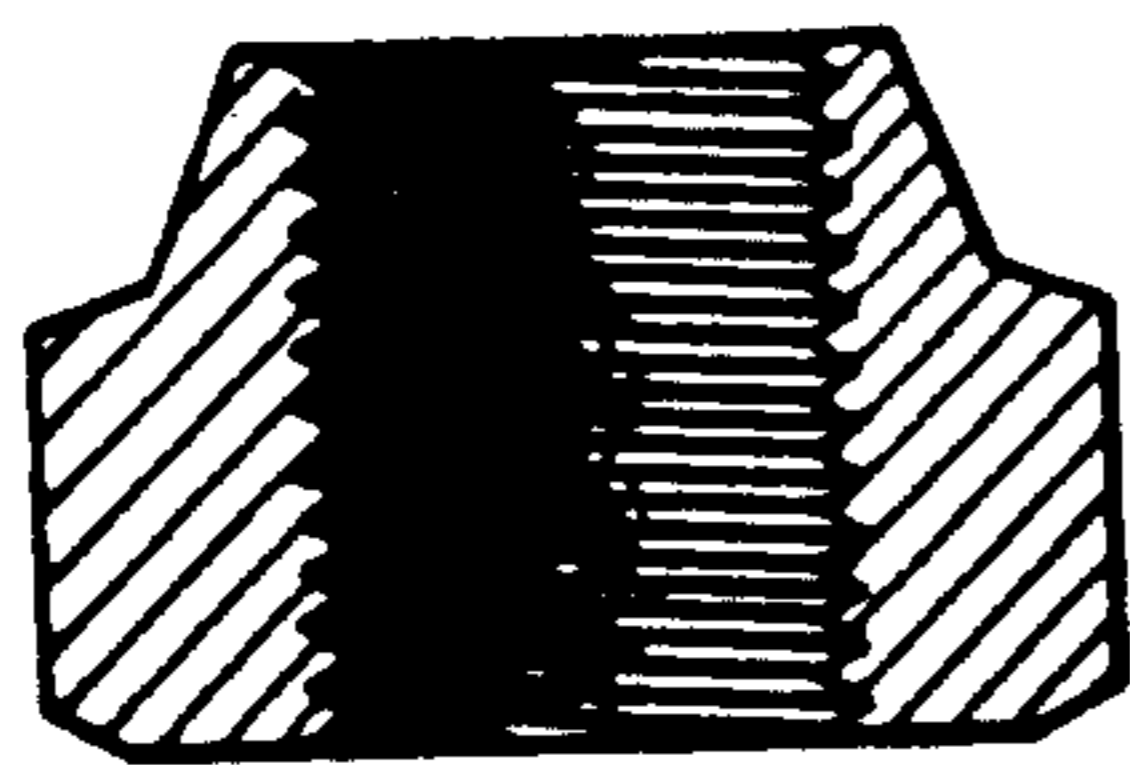

FIG. 5

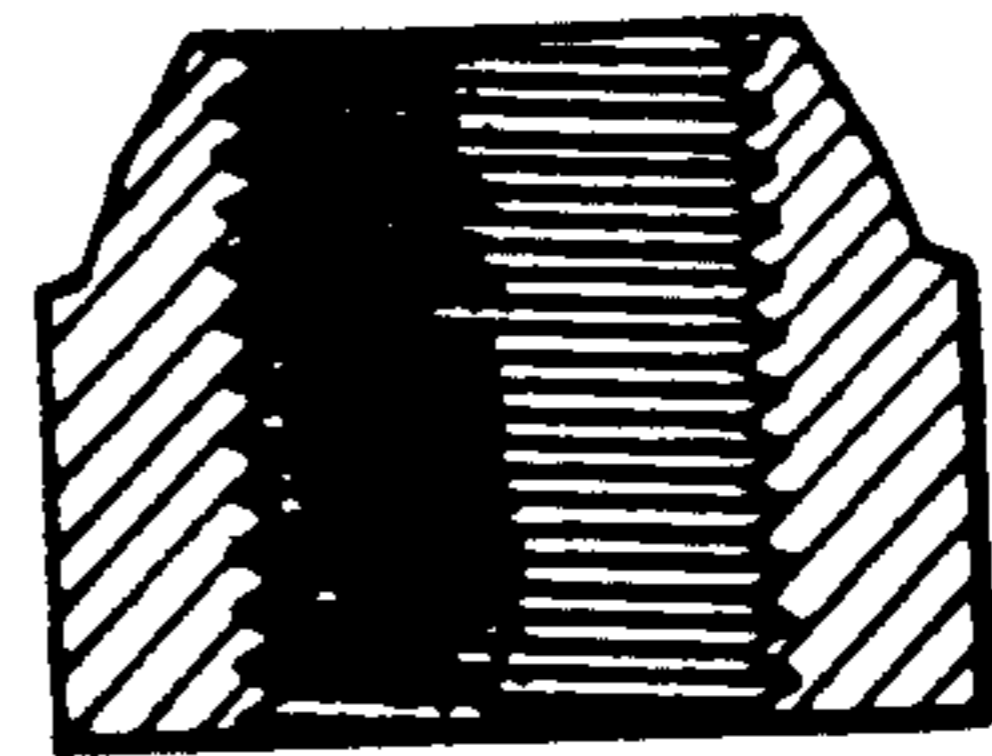

FIG. 6