



US00D332538S

United States Patent [19]

[11] Patent Number: **Des. 332,538**

Hosoe

[45] Date of Patent: **** Jan. 19, 1993**

[54] **TABLE**

- [75] Inventor: **Isao Hosoe**, Milan, Italy
- [73] Assignee: **Itoki Co. Ltd.**, Osaka, Japan
- [**] Term: **14 Years**
- [21] Appl. No.: **631,793**
- [22] Filed: **Dec. 21, 1990**

[30] **Foreign Application Priority Data**

- Aug. 29, 1990 [JP] Japan 2-28733
- [52] U.S. Cl. **D6/482; D6/487;**
D6/429
- [58] Field of Search D6/428, 429, 480, 482,
D6/483, 487, 489, 495, 499

[56] **References Cited**

U.S. PATENT DOCUMENTS

D. 116,551	9/1939	Cumfer	D6/483
D. 164,295	8/1951	Gierlich	D6/429
D. 175,110	7/1955	Howard	D6/483
D. 202,046	8/1965	Zierhut	D6/429
D. 207,958	6/1967	Jakobsen	D6/487
D. 248,137	6/1978	Peterson	D6/489
D. 291,851	9/1987	Salvato	D6/482
3,217,672	11/1965	Haughey	D6/482 X

OTHER PUBLICATIONS

Domus—Sep. 1989, Westnofa table at top left.

Primary Examiner—Nelson C. Holtje

Assistant Examiner—J. E. Seeger

Attorney, Agent, or Firm—Rogers & Killeen

[57] **CLAIM**

The ornamental design for a table, as shown and described.

DESCRIPTION

FIG. 1 is a perspective view of table, showing my new design;
 FIG. 2 is a front elevational view;
 FIG. 3 is a rear elevational view;
 FIG. 4 is a right side elevational view;
 FIG. 5 is a left side elevational view;
 FIG. 6 is a top plan view;
 FIG. 7 is a bottom plan view;
 FIG. 8 is a cross-sectional view, taken along line VIII-VIII i FIG. 5;
 FIG. 9 is a right side elevational view in folded condition; and,
 FIG. 10 is a left side elevational view in folded condition.

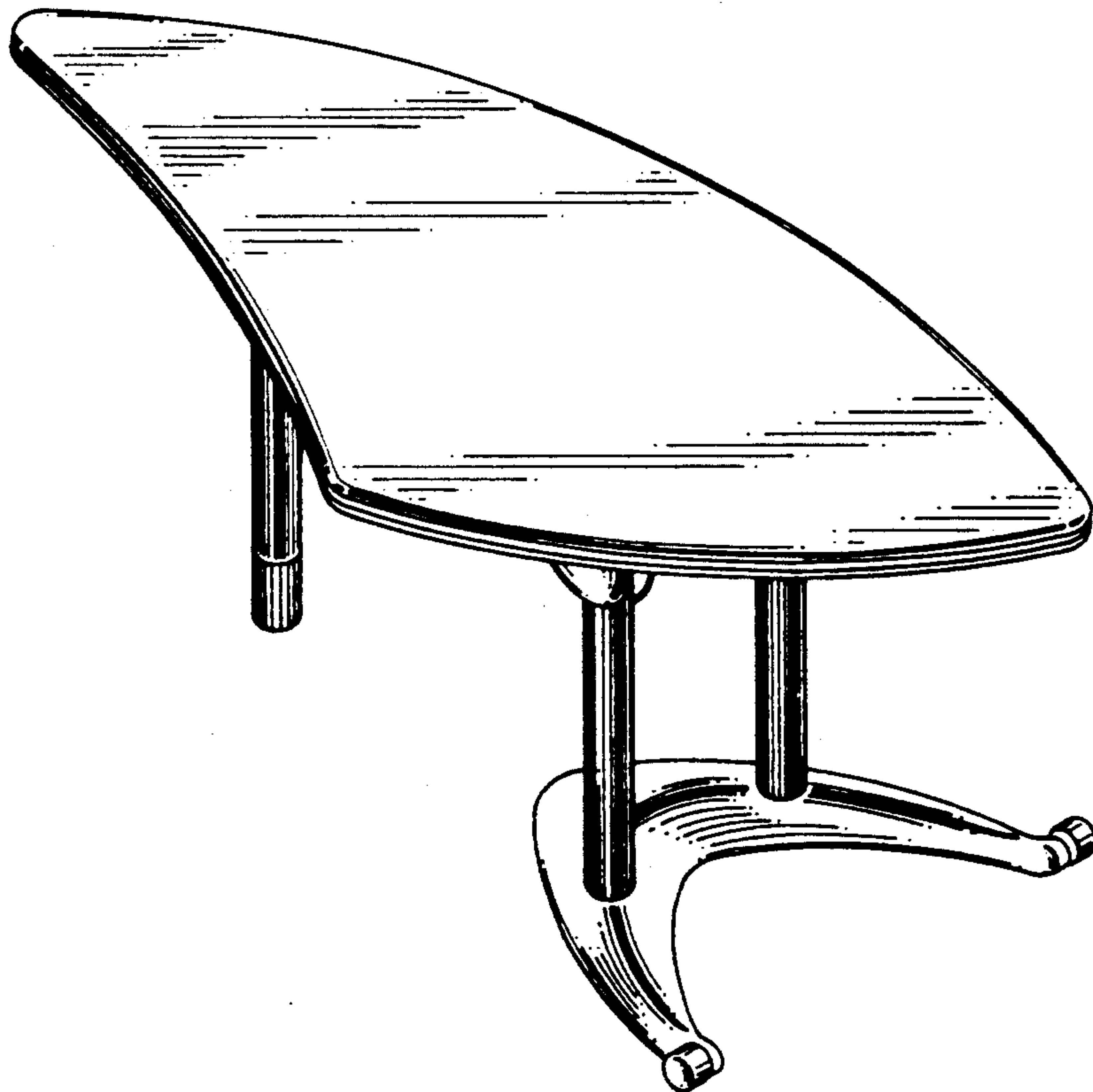

FIG. 1

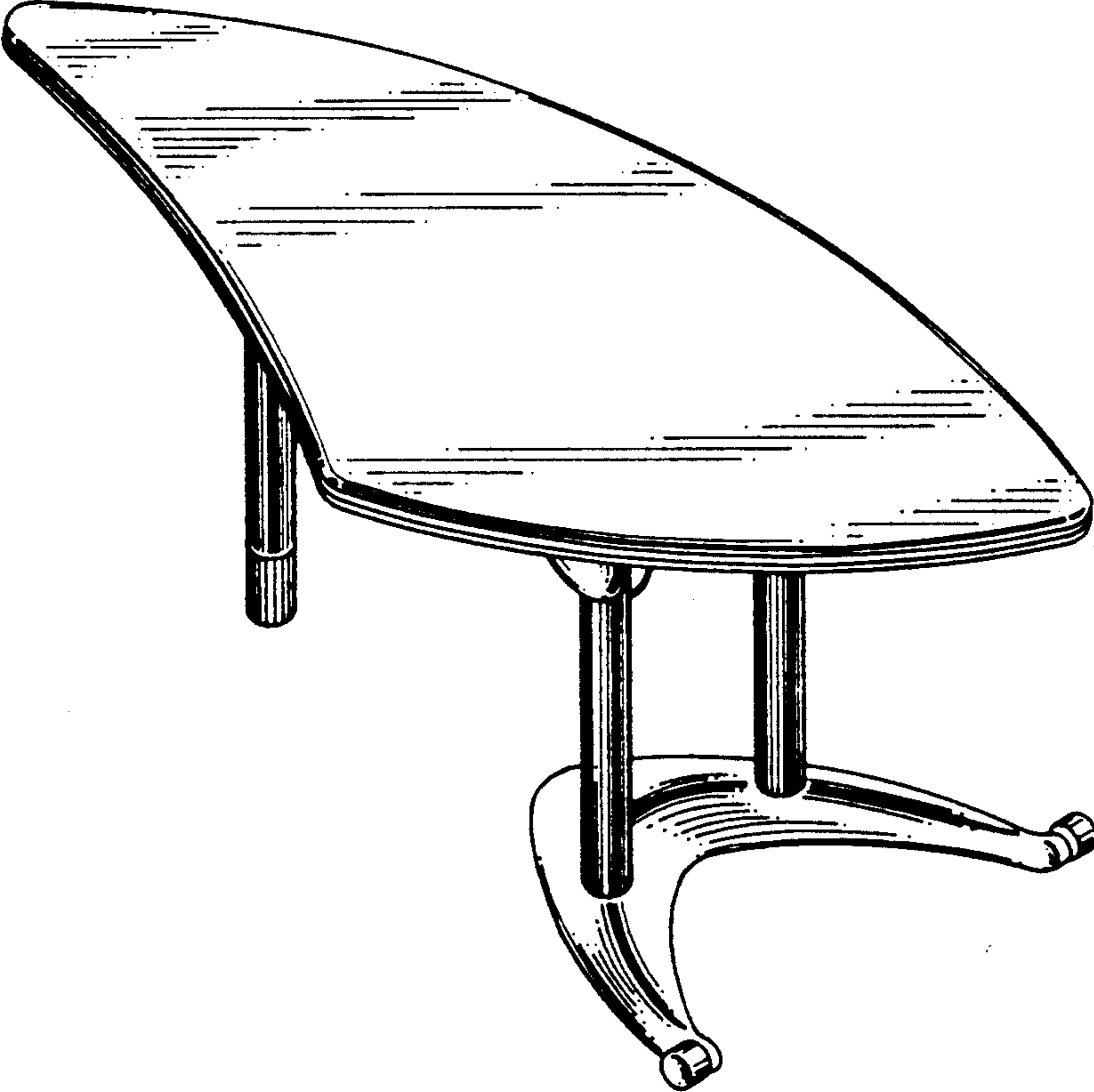

FIG. 2

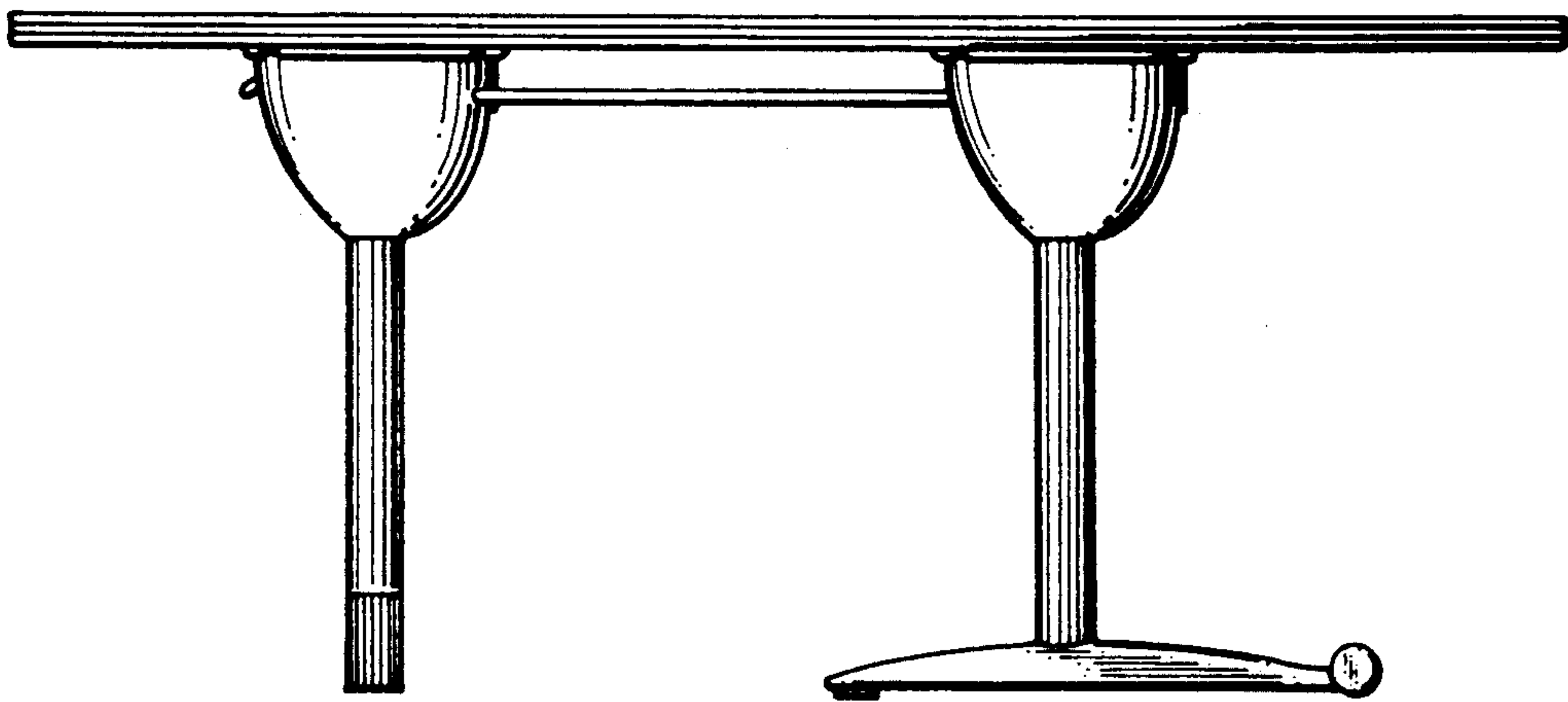

FIG. 3

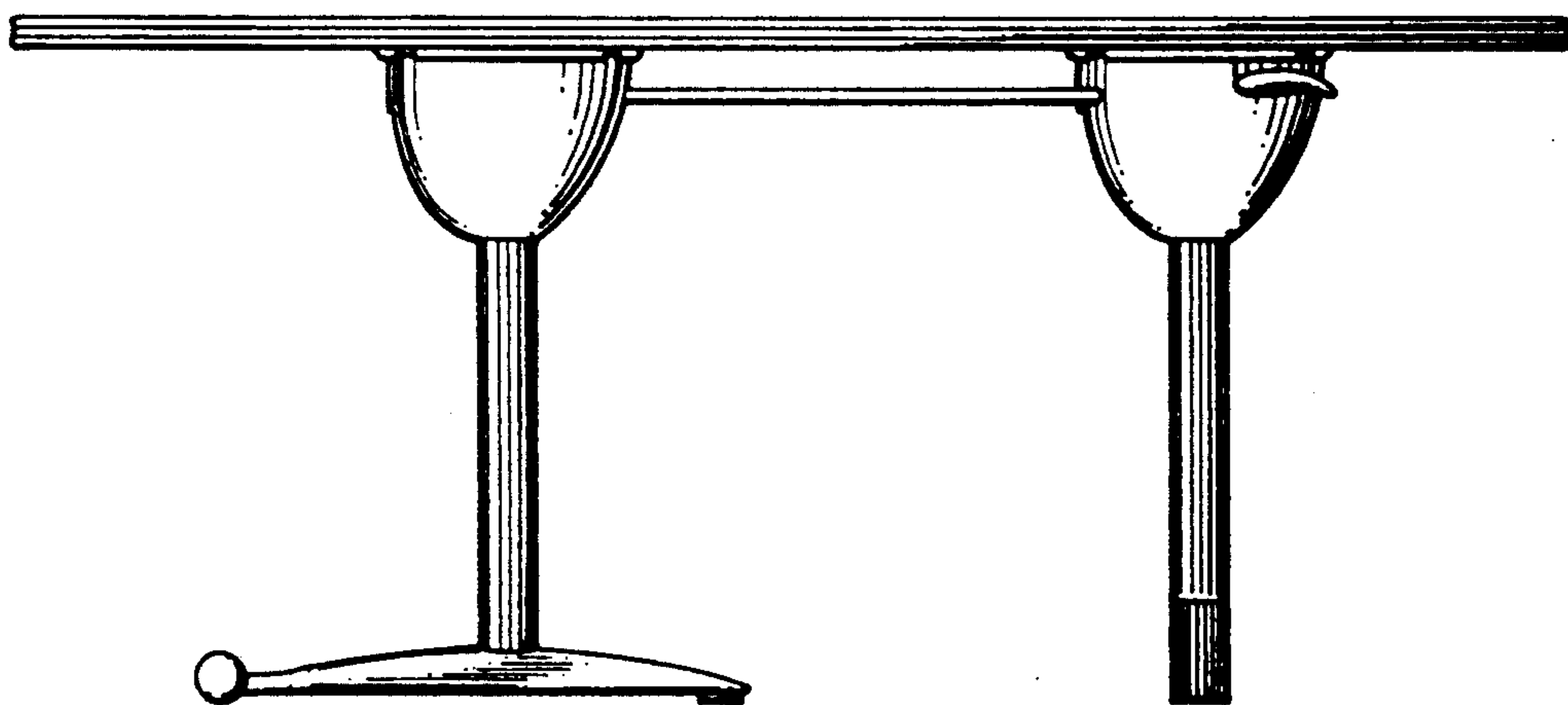

FIG. 4

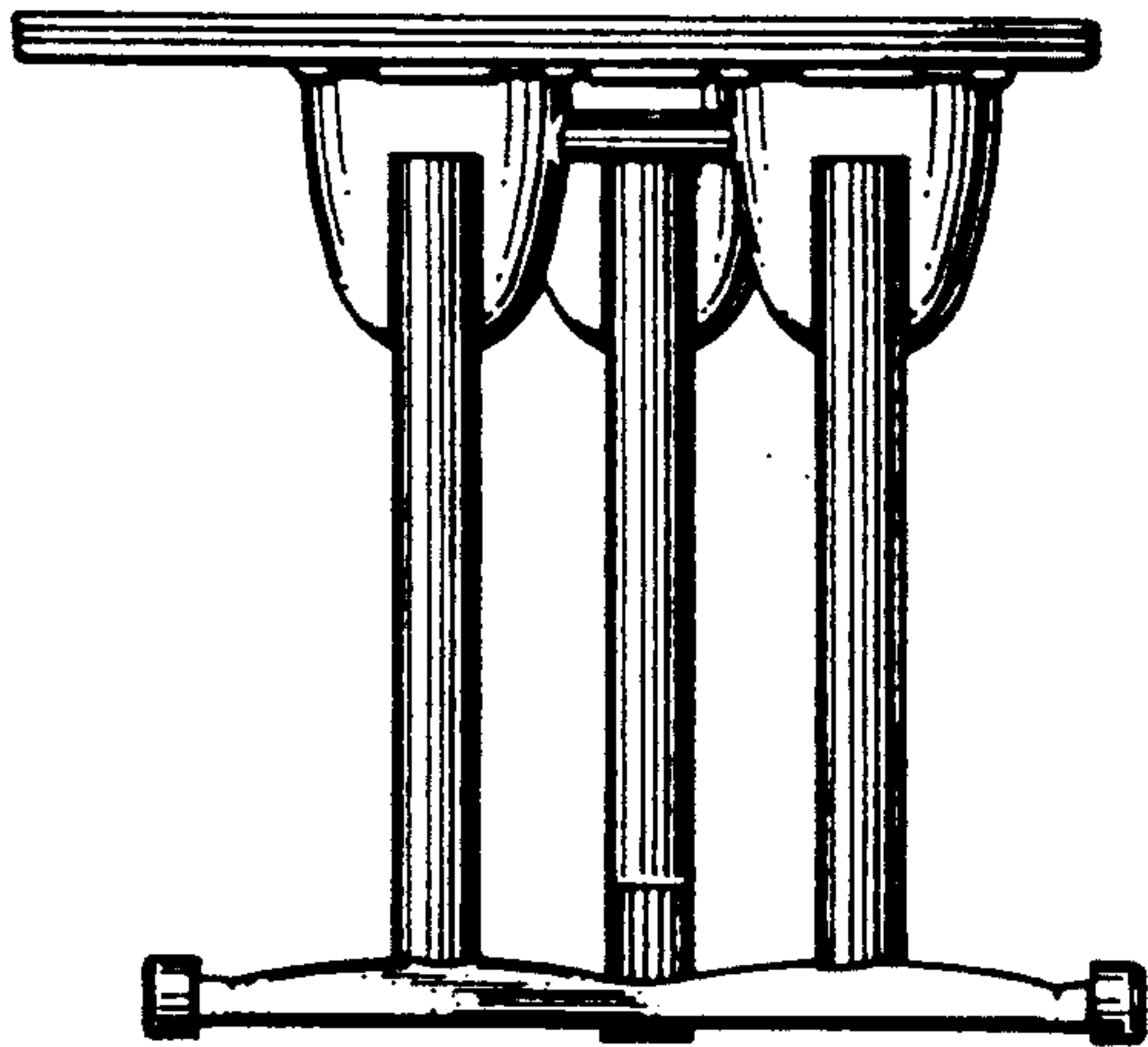

FIG. 5

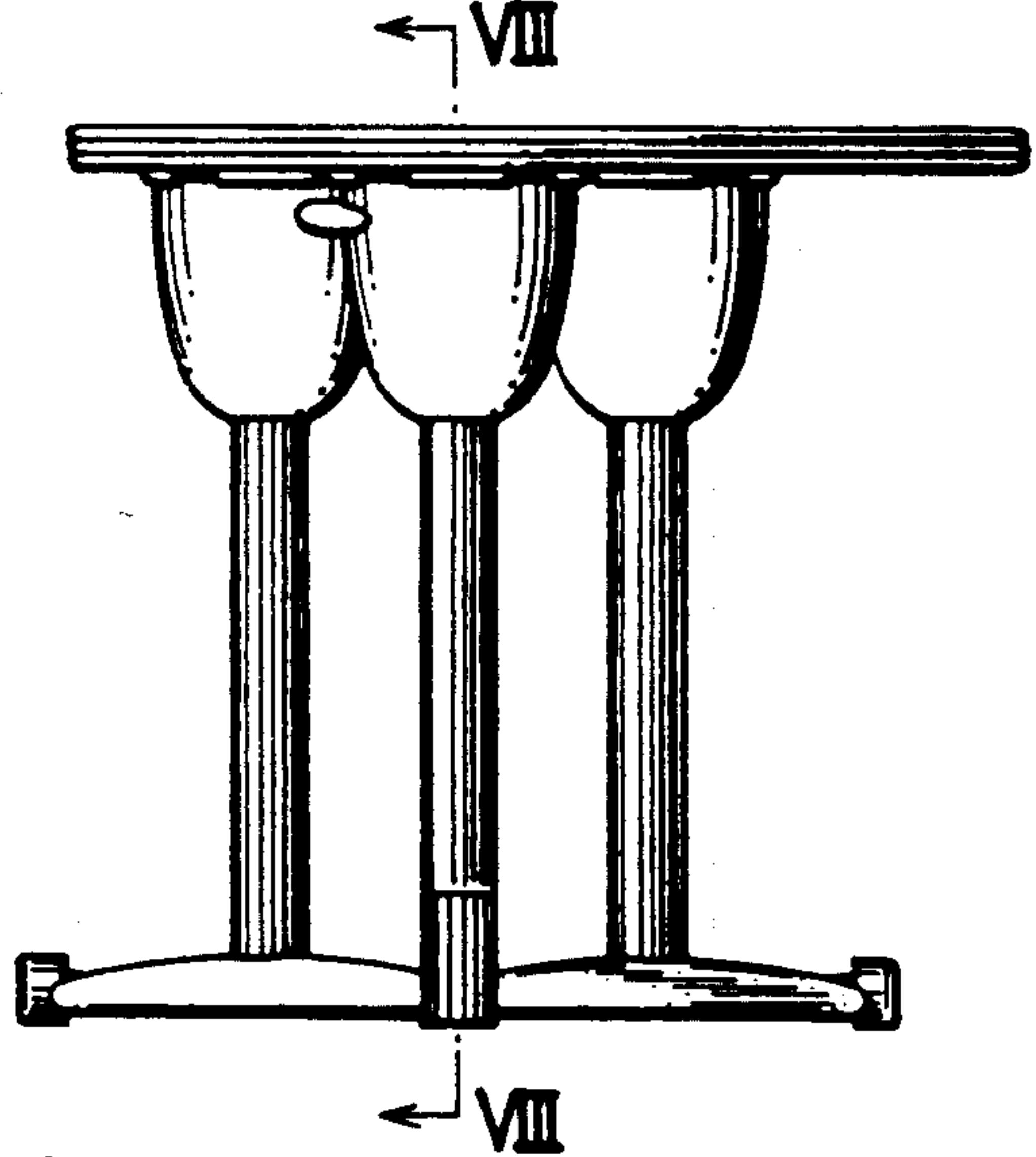

FIG. 6

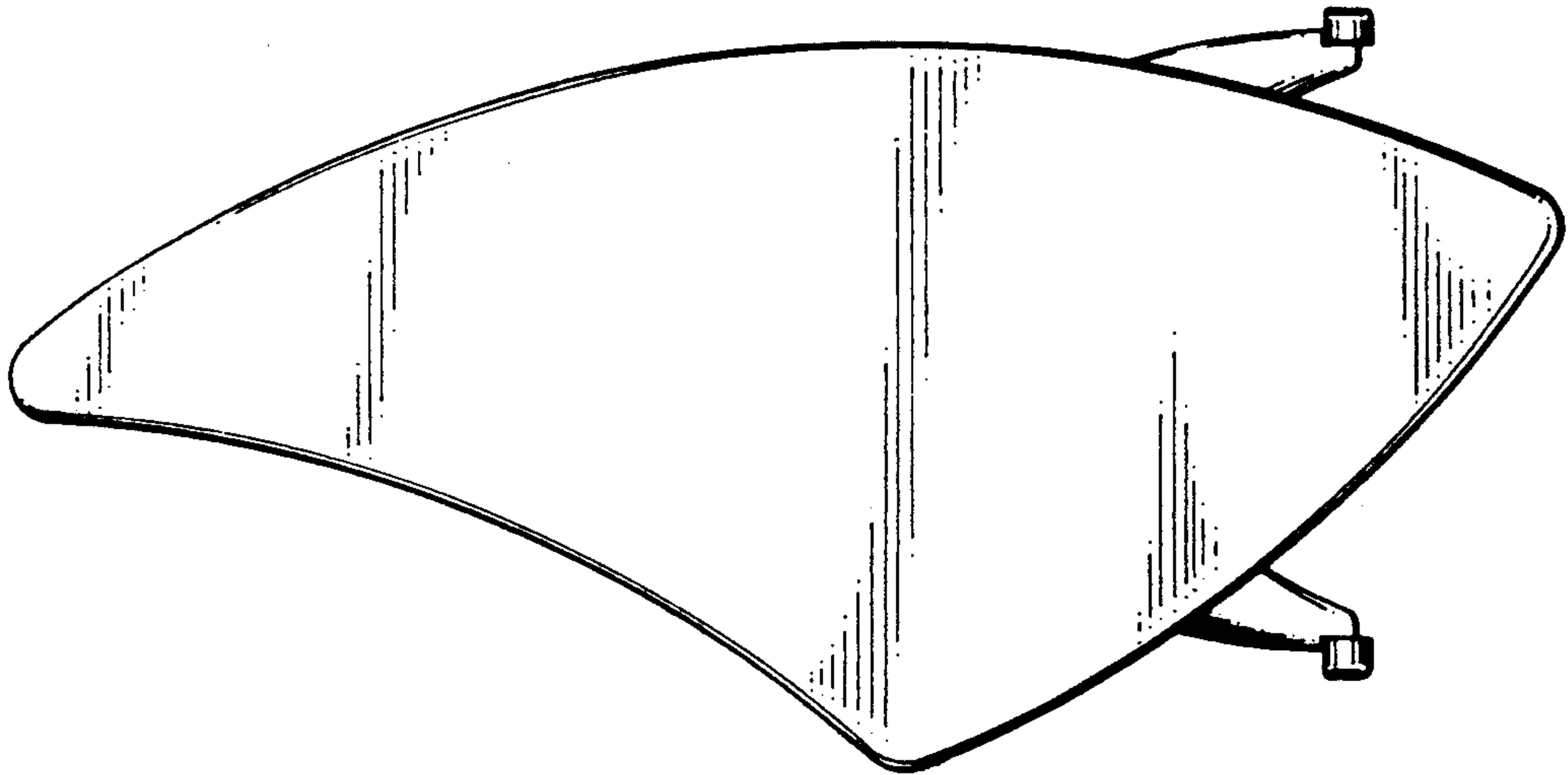

FIG. 7

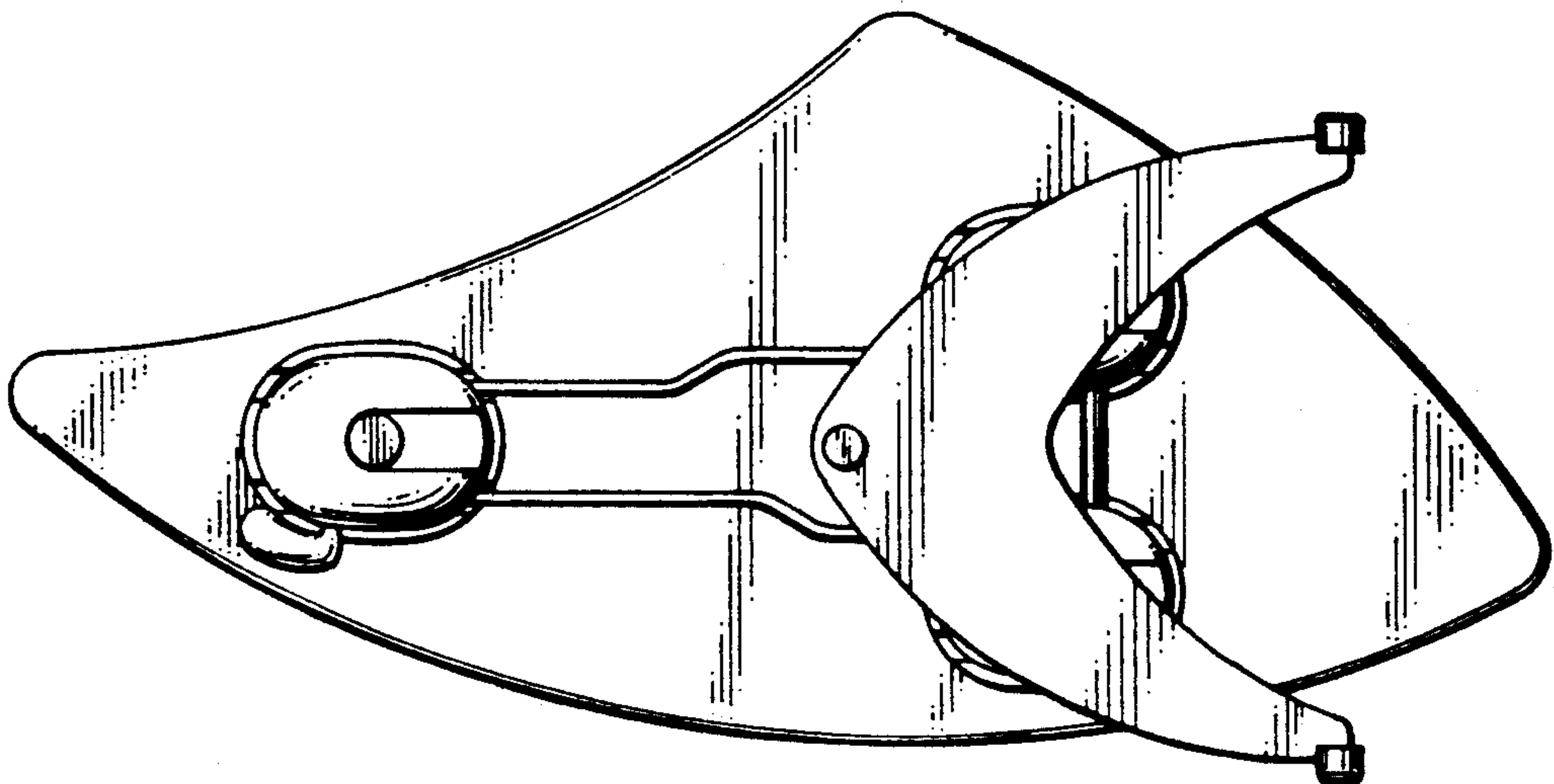

FIG. 8

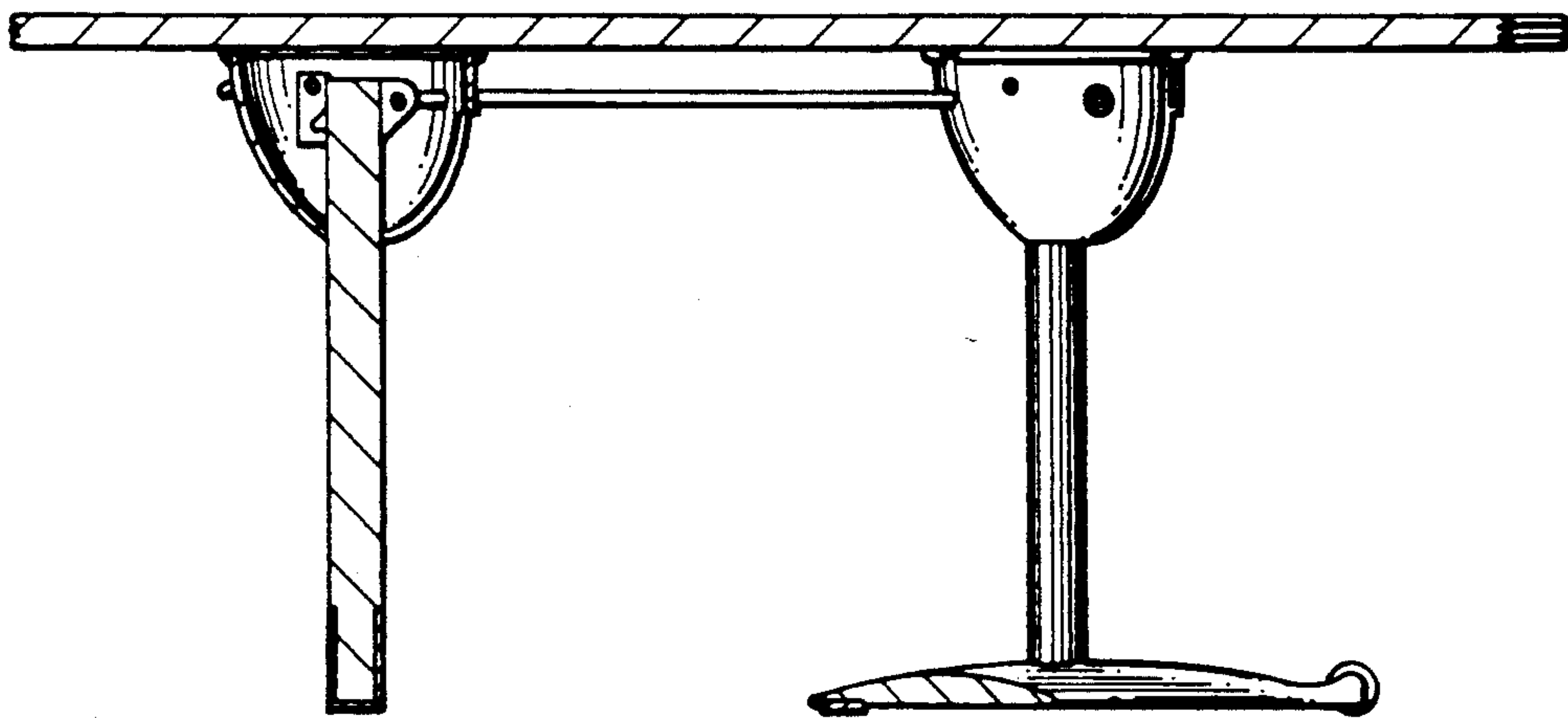

FIG. 9

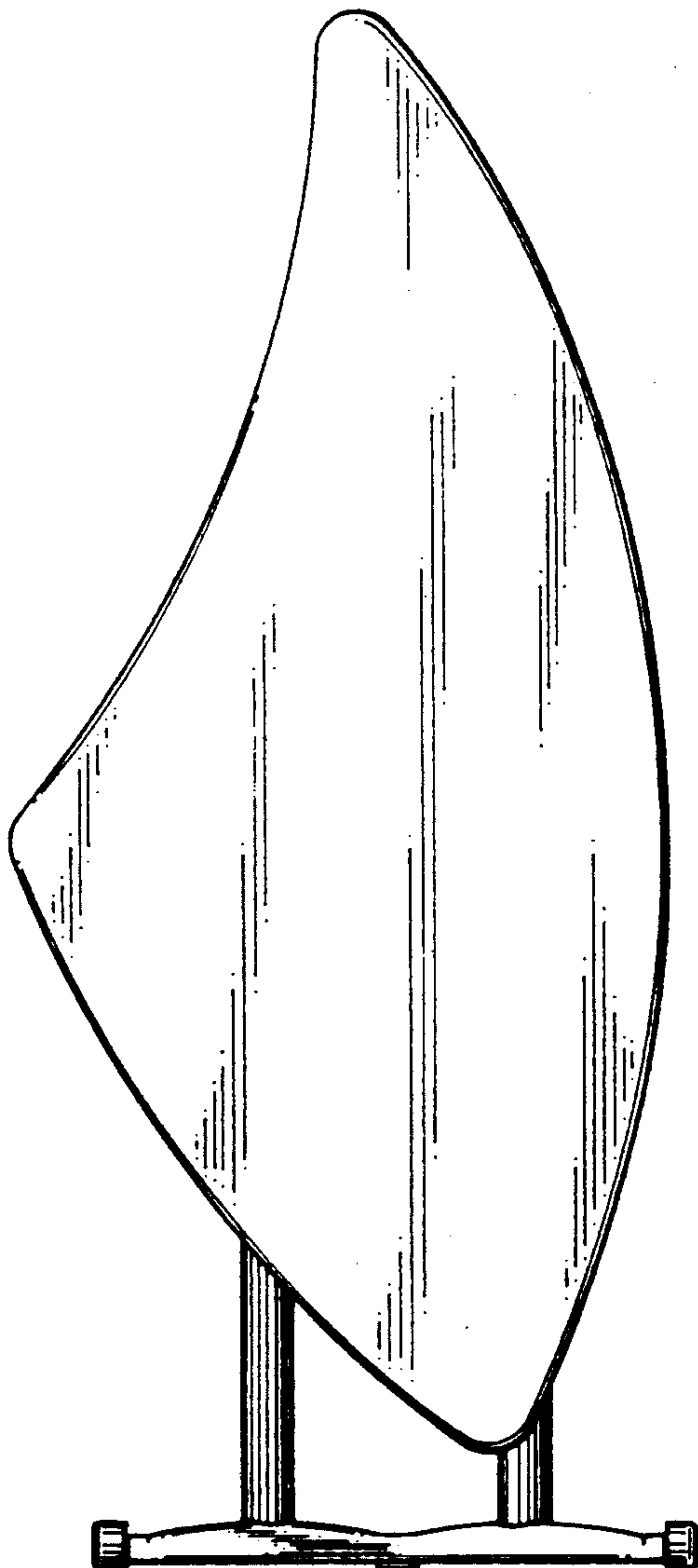

FIG. 10

