



US00D332524S

United States Patent [19]

[11] Patent Number: Des. 332,524

Gray et al.

[45] Date of Patent: ** Jan. 19, 1993

[54] TOOL BOX

[57] CLAIM

[75] Inventors: **Larry R. Gray; Gerald F. Slocum,** both of Danville, Va.; **Donald C. Andrus,** High Point, N.C.; **James E. Edgell,** Roanoke, Va.

The ornamental design for a tool box, as shown and described.

[73] Assignee: **The Disston Company,** Greensboro, N.C.

DESCRIPTION

[**] Term: **14 Years**

FIG. 1 is a front elevational view of a tool box showing our new design;

[21] Appl. No.: **392,039**

FIG. 2 is a rear elevational view thereof;

[22] Filed: **Aug. 10, 1989**

FIG. 3 is a left side elevational view thereof;

[52] U.S. Cl. **D3/30.1; D3/74; D3/78; D6/440**

FIG. 4 is a top plan view thereof;

[58] Field of Search **D3/30.1, 35, 72, 74, D3/78; D6/440; D9/341, 424, 425; D19/75; D34/45; 206/372, 373; 220/94 R; 312/DIG. 33**

FIG. 5 is a bottom plan view thereof;

[56] **References Cited**

U.S. PATENT DOCUMENTS

D. 266,544	10/1982	Crutchfield	D3/30.1
D. 293,625	1/1988	Bankier	D3/35
D. 305,179	12/1989	Collister	D3/30.1
D. 315,445	3/1991	Lanius	D3/72
2,386,573	10/1945	Randall	312/DIG. 33
2,740,517	4/1956	Evans	220/94 R
3,985,409	10/1976	Kneier	312/DIG. 33
4,150,746	4/1979	Buglione	206/372
4,714,158	12/1987	Oltman et al.	206/372
4,840,273	6/1989	Zavacki	206/372

FIG. 6 is a rear elevational view thereof, the side flaps being shown in an open position;

FIG. 7 is a top plan view thereof, the lid being shown in an open position;

FIG. 8 is a front elevational view of FIG. 7;

FIG. 9 is an exploded left side view of FIG. 7;

FIG. 10 is a top plan view of an alternate embodiment of the design shown in FIG. 1, the broken lines showing a saw being for illustrative purposes only and forming no part of the claimed design;

FIG. 11 is a top plan view of the front tool holder element shown in FIG. 9;

FIG. 12 is a front elevational view of FIG. 11;

FIG. 13 is a rear elevational view of FIG. 11;

FIG. 14 is a left side elevational view of FIG. 11, the right side being a mirror image;

FIG. 15 is a bottom plan view of FIG. 11;

FIG. 16 is a rear elevational view of a second embodiment of the design shown in FIG. 1;

FIG. 17 is a left side elevational view of FIG. 16, the right side being a mirror image;

FIG. 18 is a top plan view of a third embodiment of the design shown in FIG. 1;

FIG. 19 is a perspective view of FIG. 7;

FIG. 20 is a bottom perspective view of FIG. 11; and,

FIG. 21 is a top perspective view of FIG. 11.

The broken lines showing a tray arrangement in FIGS. 7, 11, 13, 18, 19, and 21 are for illustrative purposes only and form no part of the claimed design.

Primary Examiner—A. Hugo Word
Assistant Examiner—Celia A. Murphy
Attorney, Agent, or Firm—Burns, Doane, Swecker & Mathis

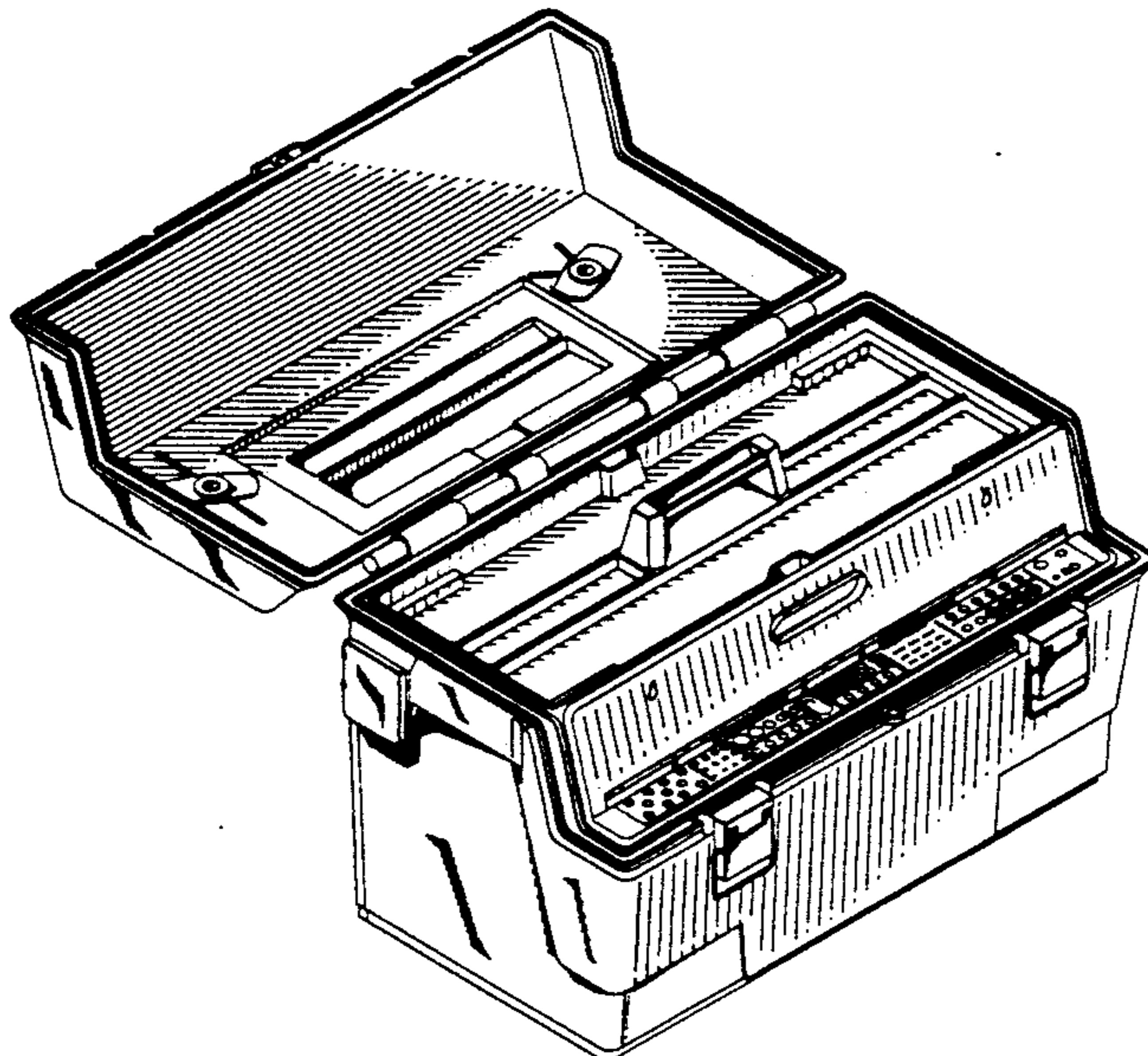

FIG. 1

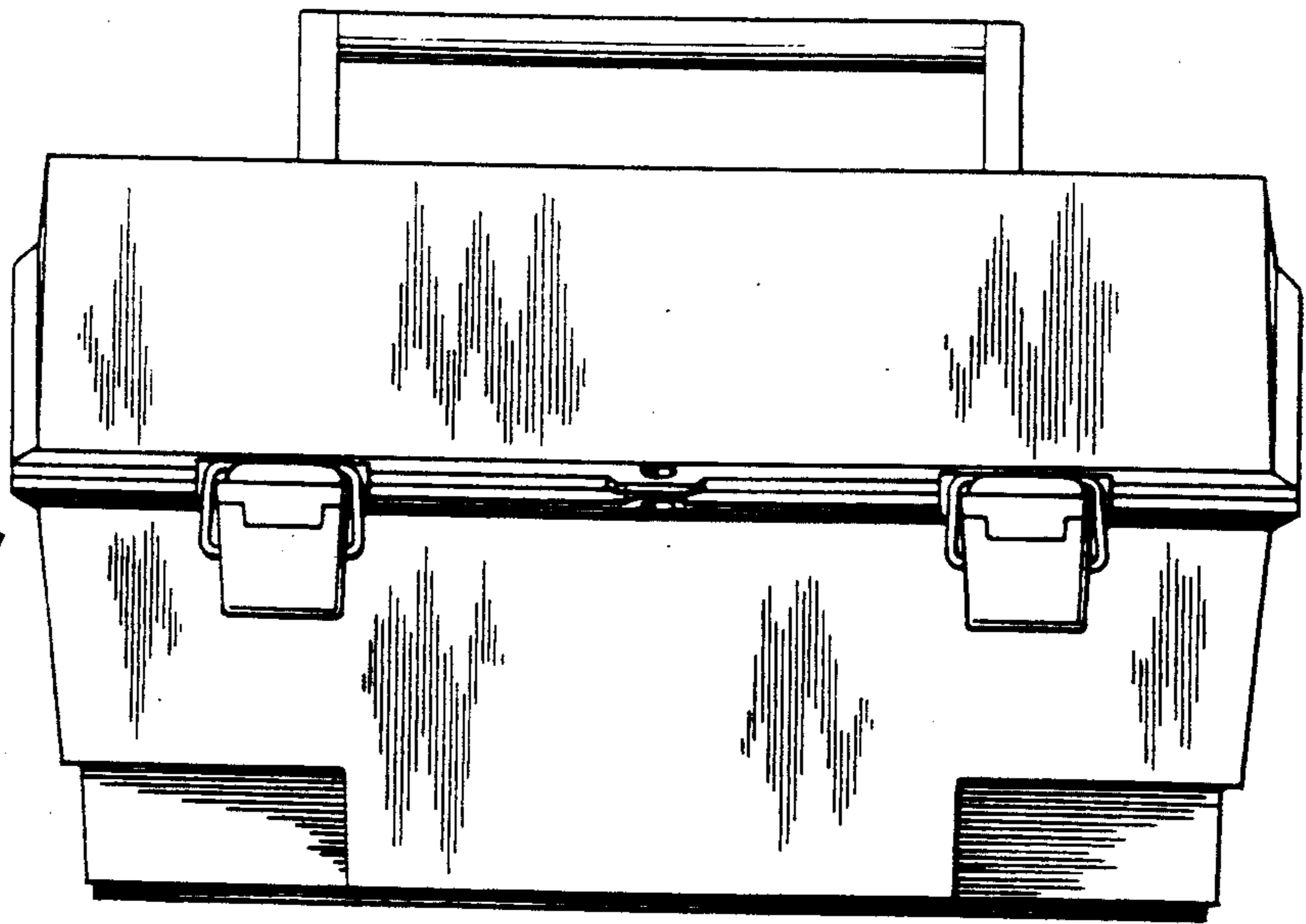

FIG. 2

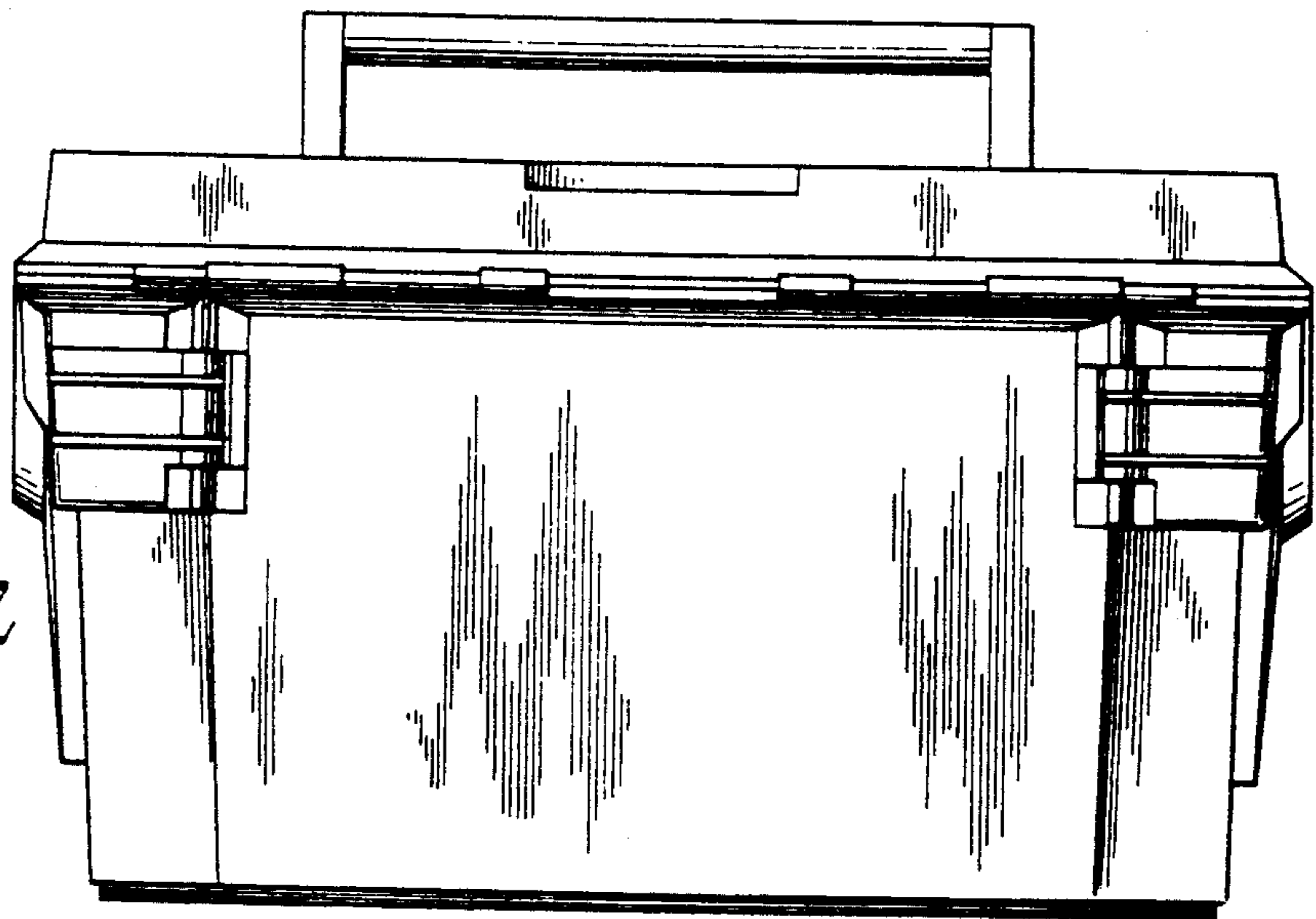

FIG. 3

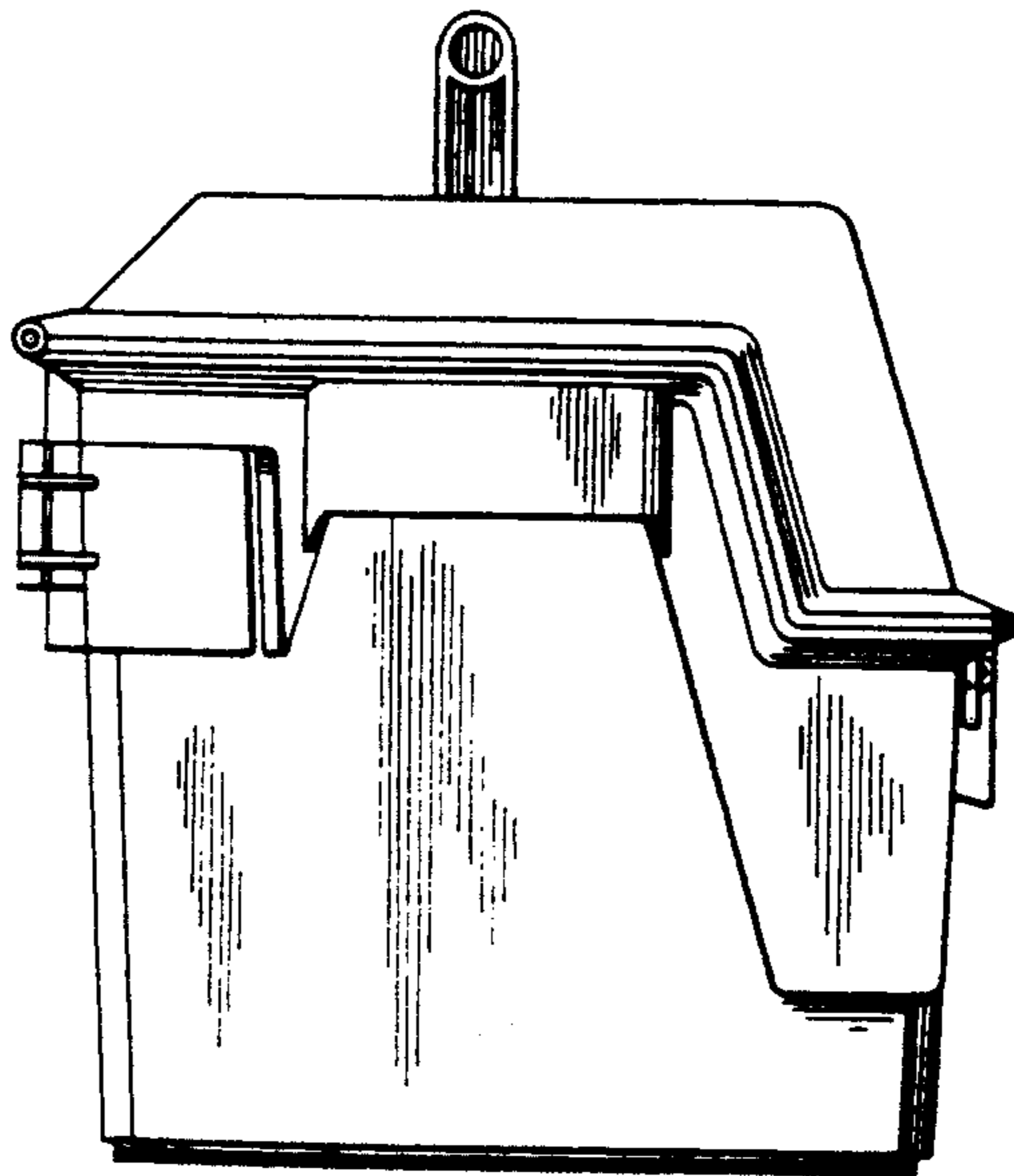

Fig. 4

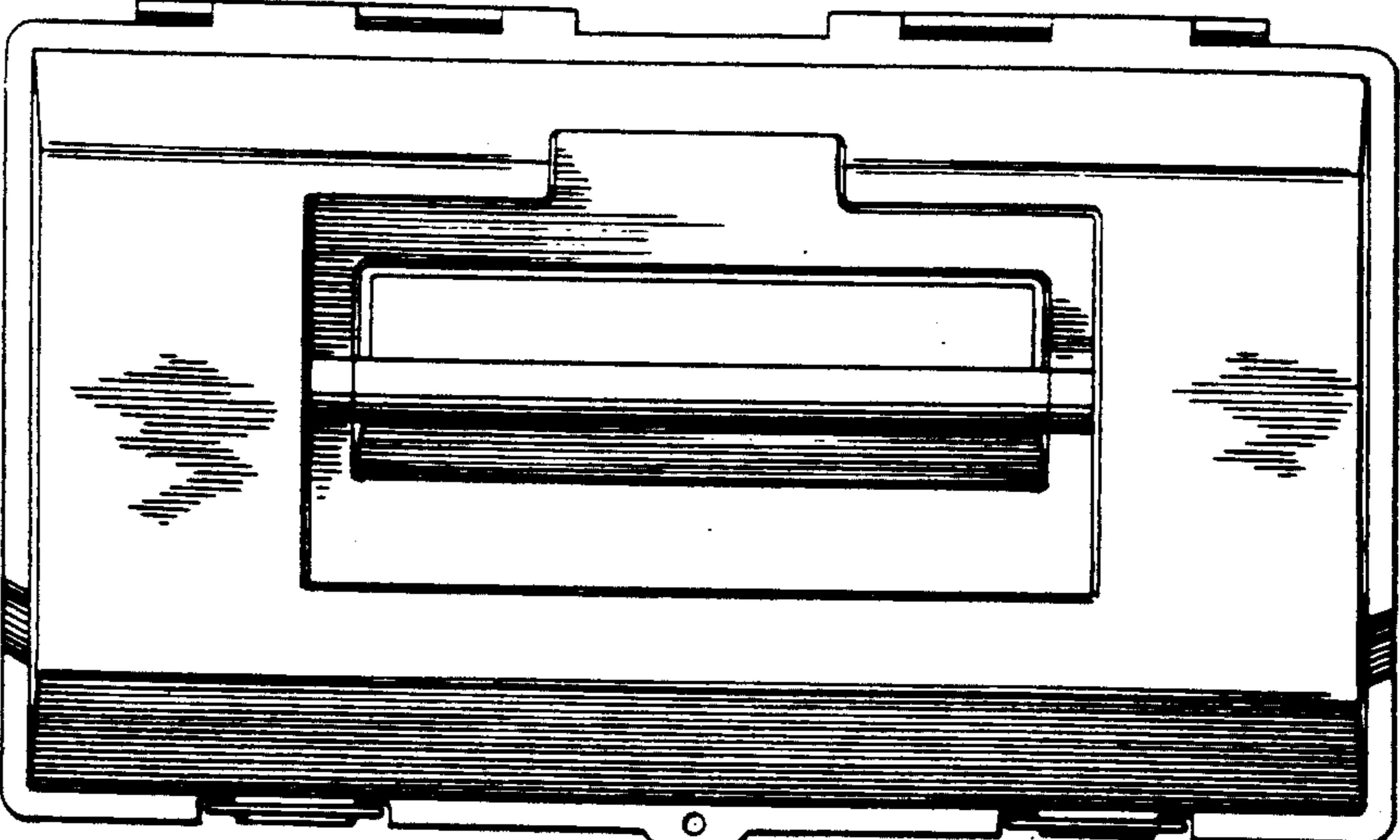

Fig. 5

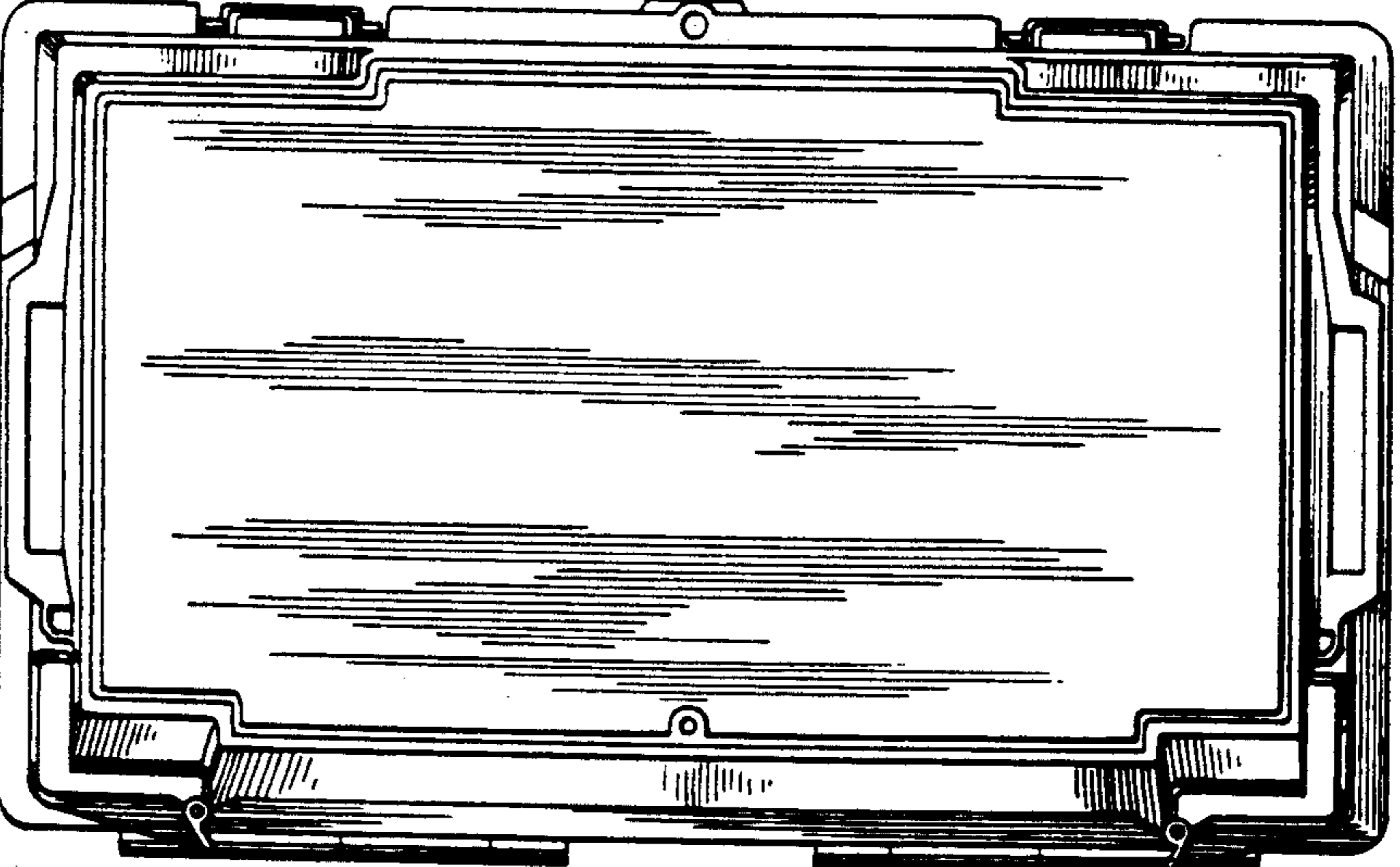

Fig. 6

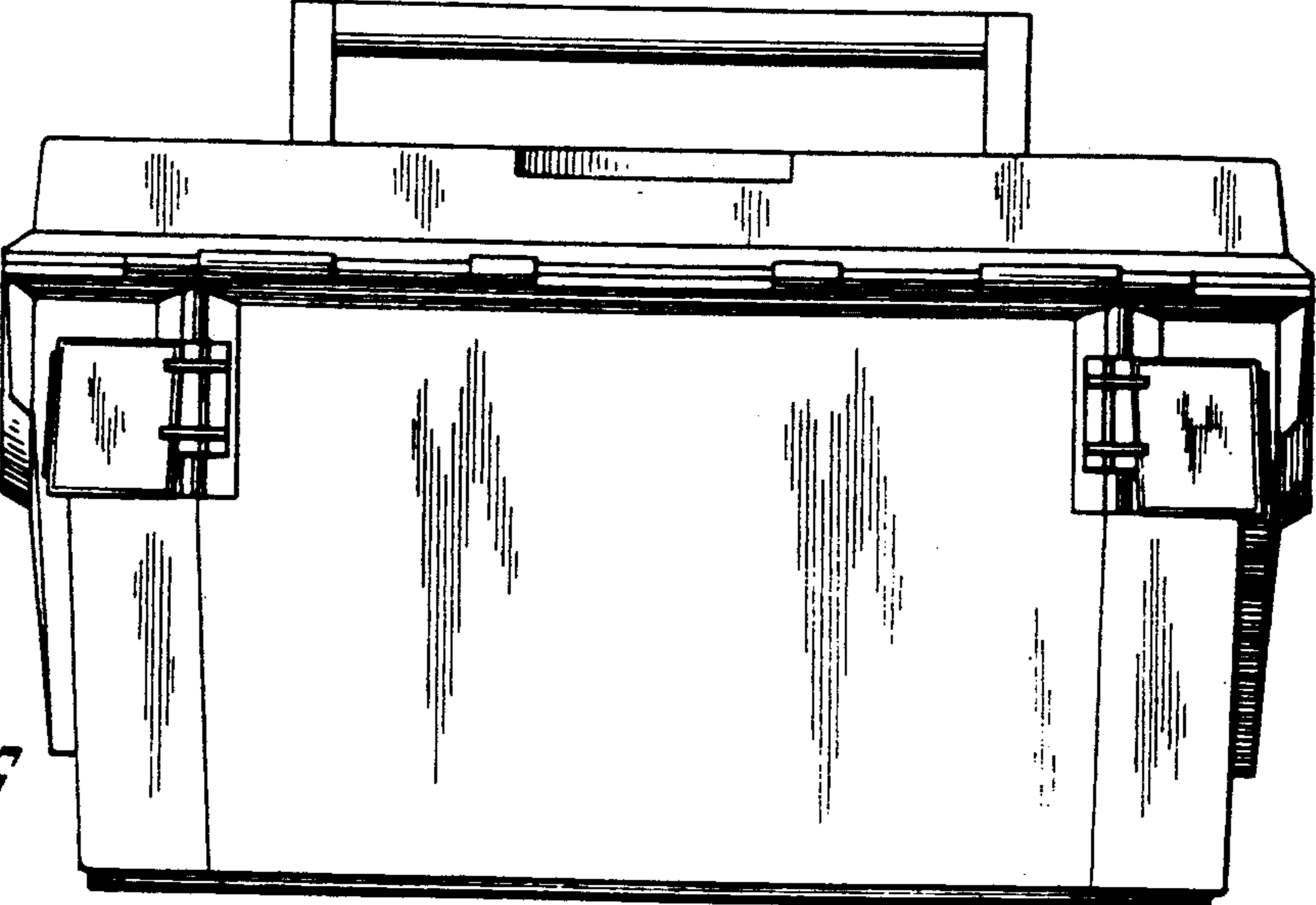

Fig. 1

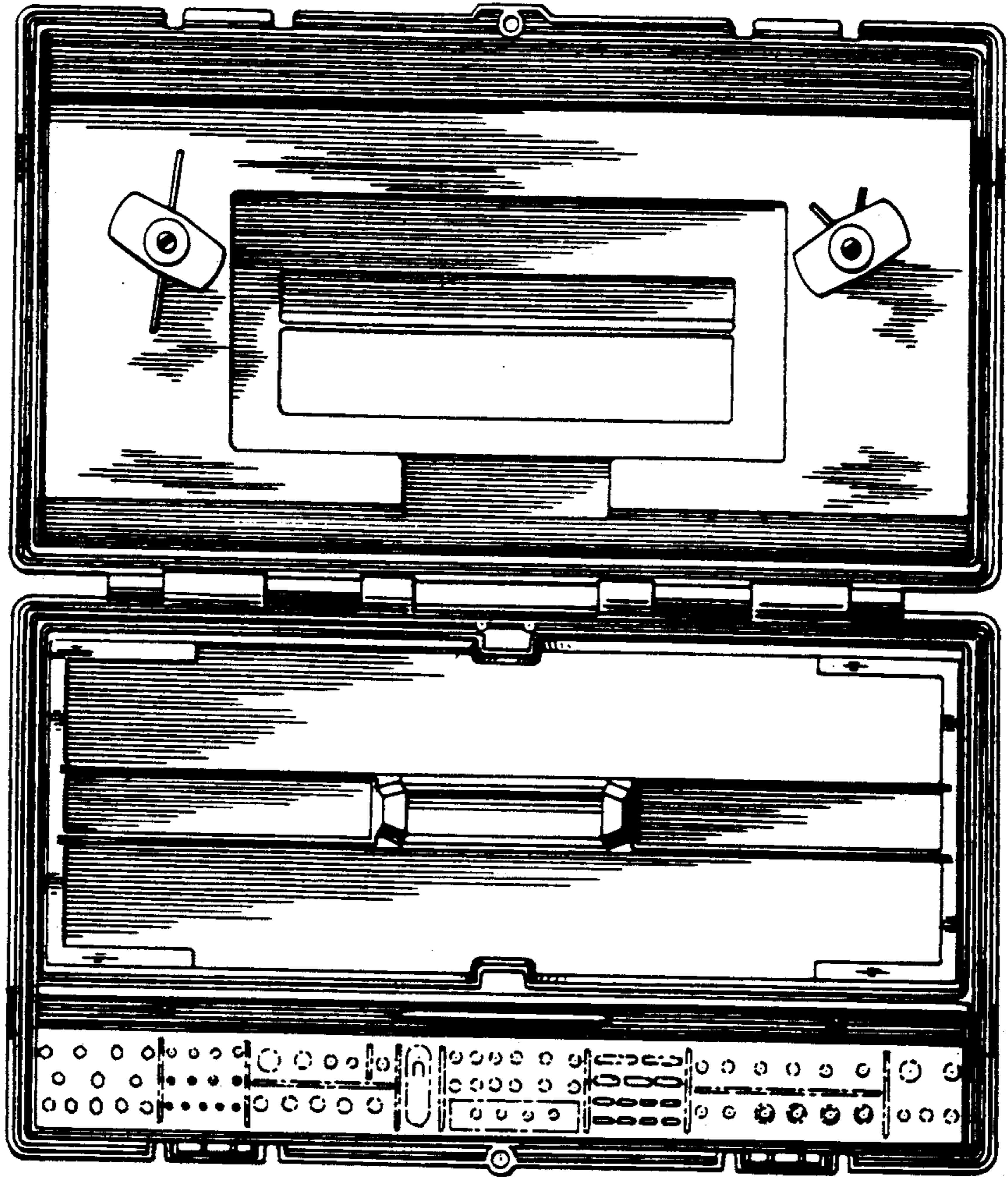
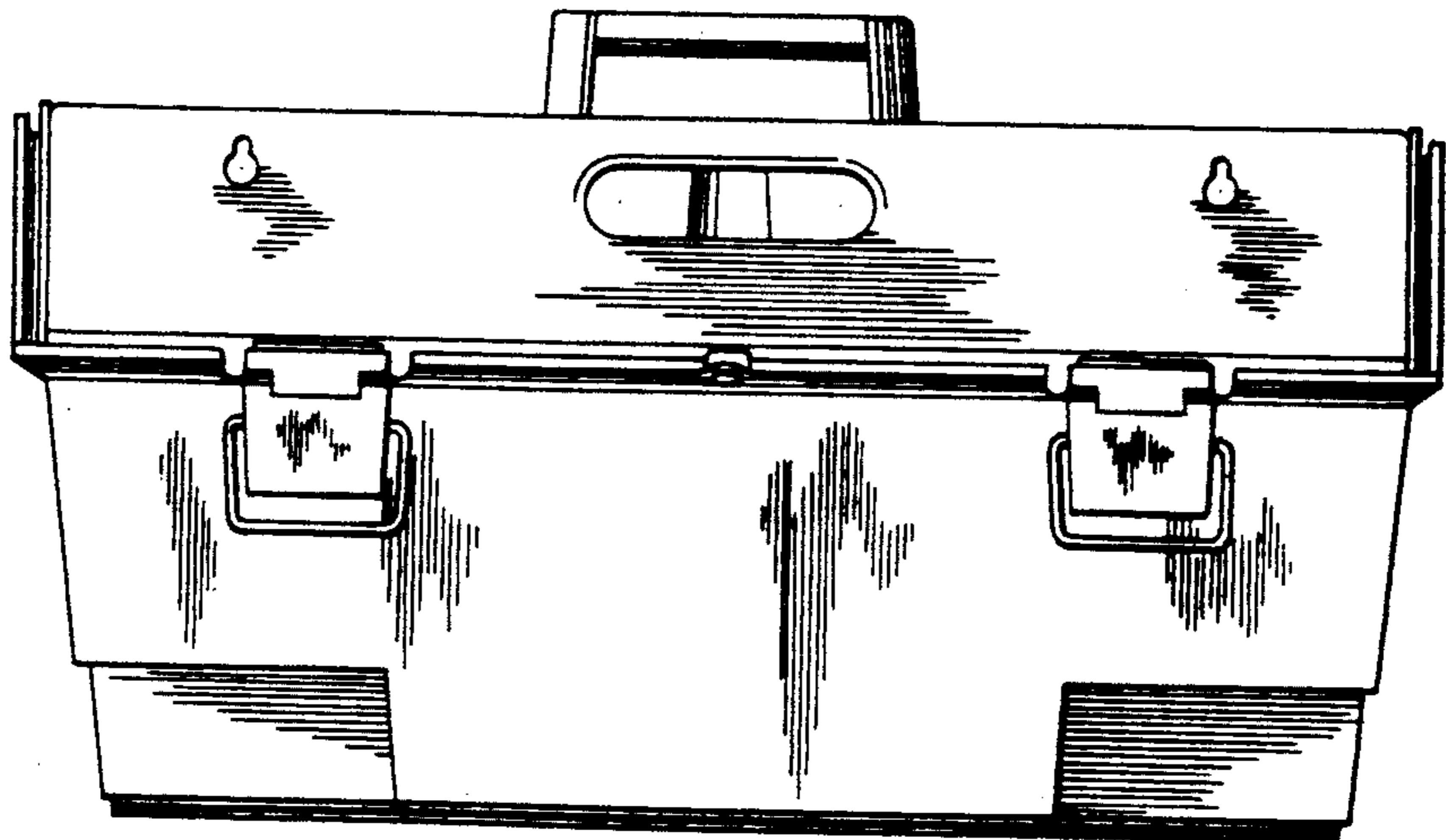

Fig. 2



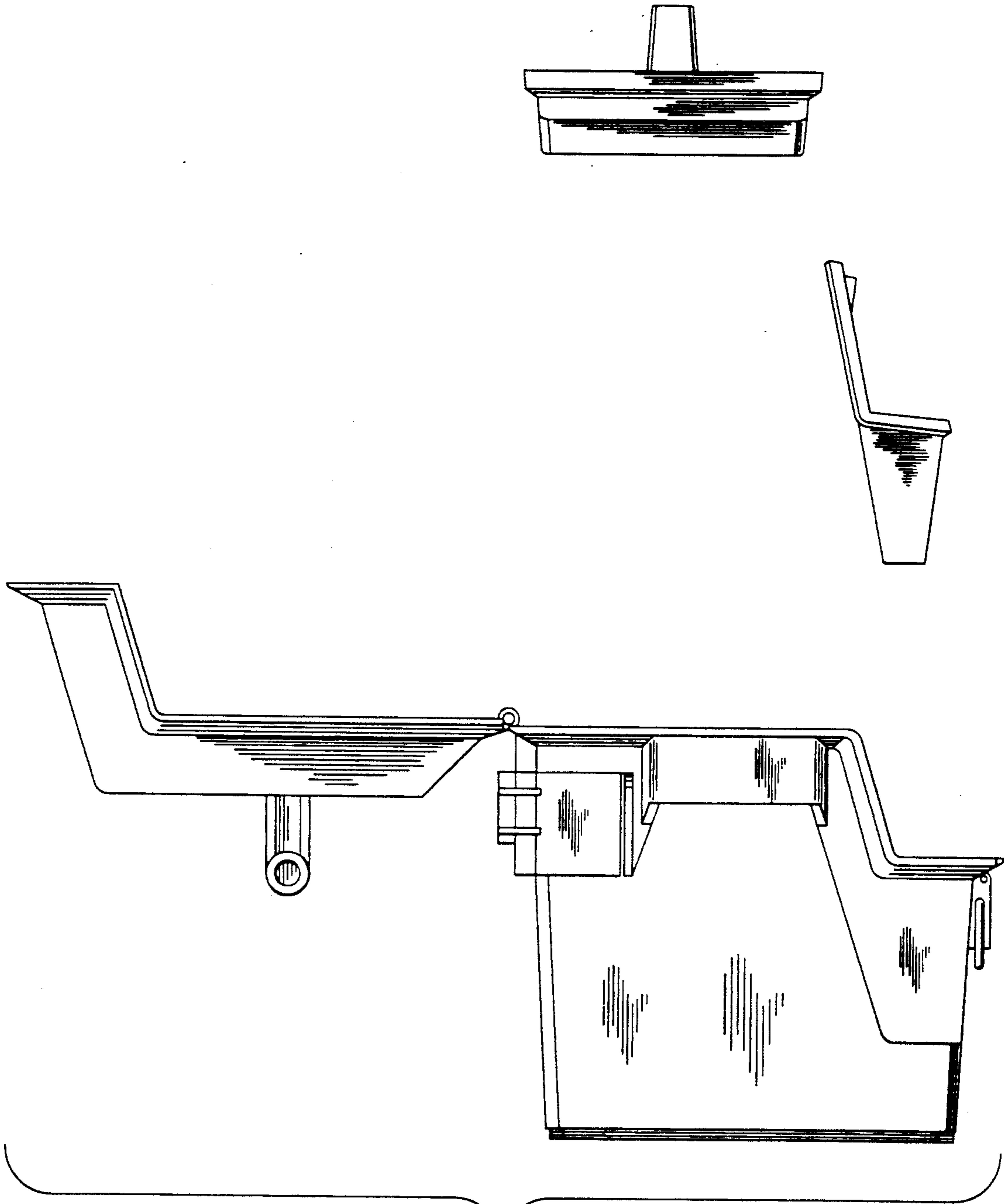

FIG. 9

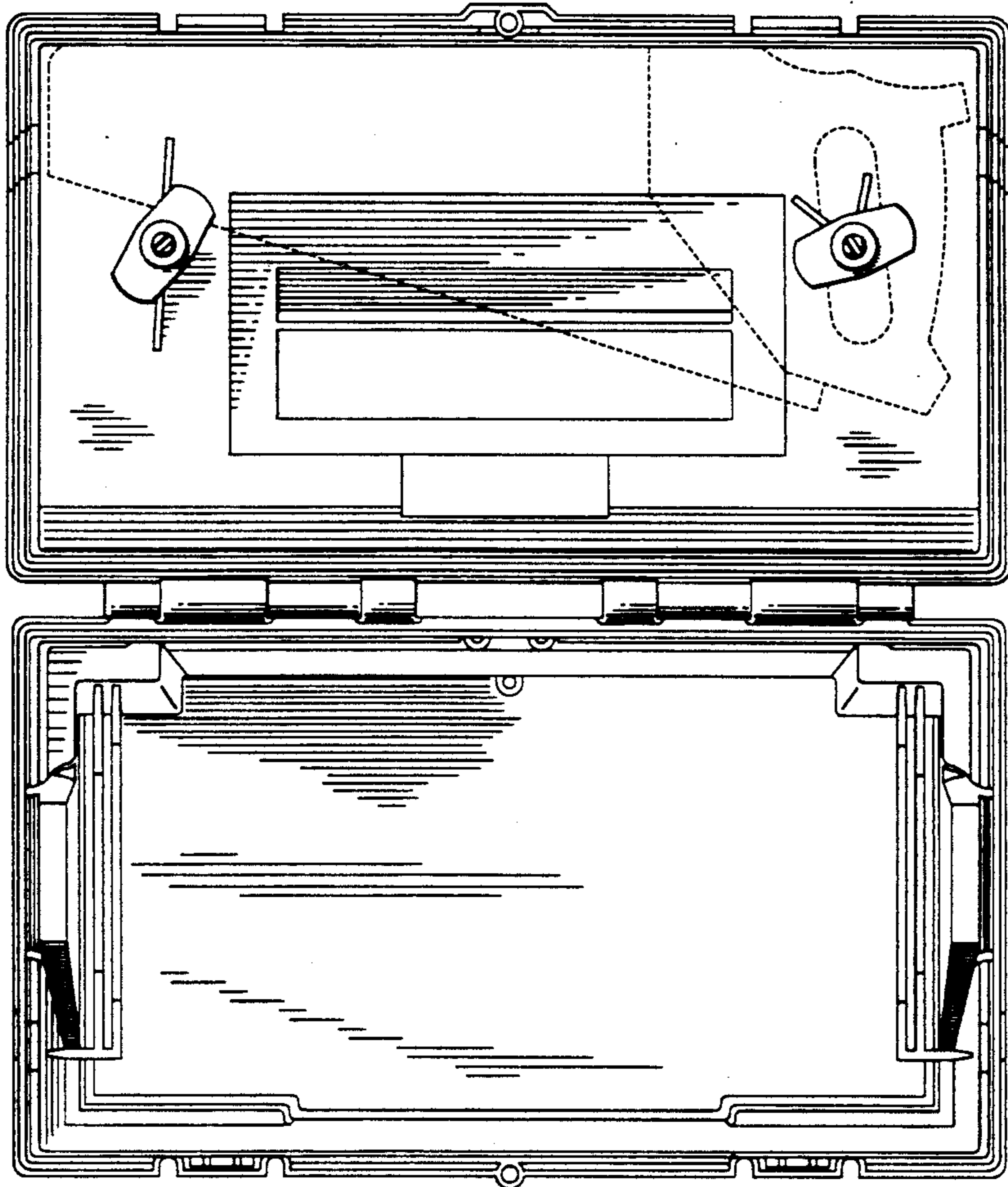
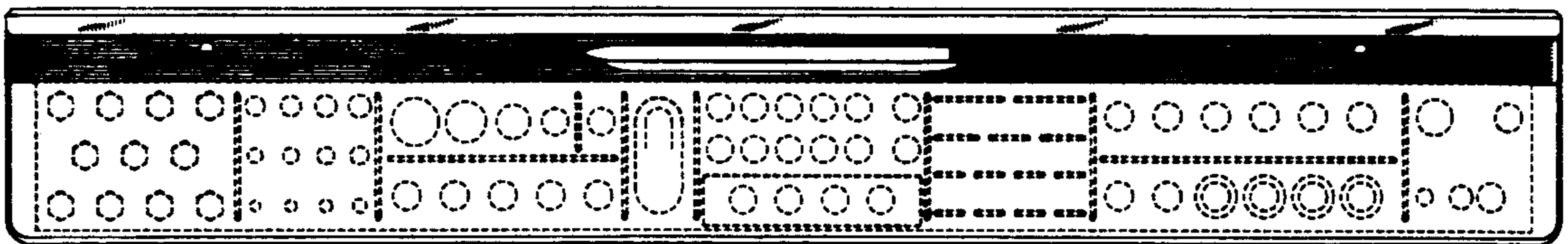

FIG. 10

FIG. 11



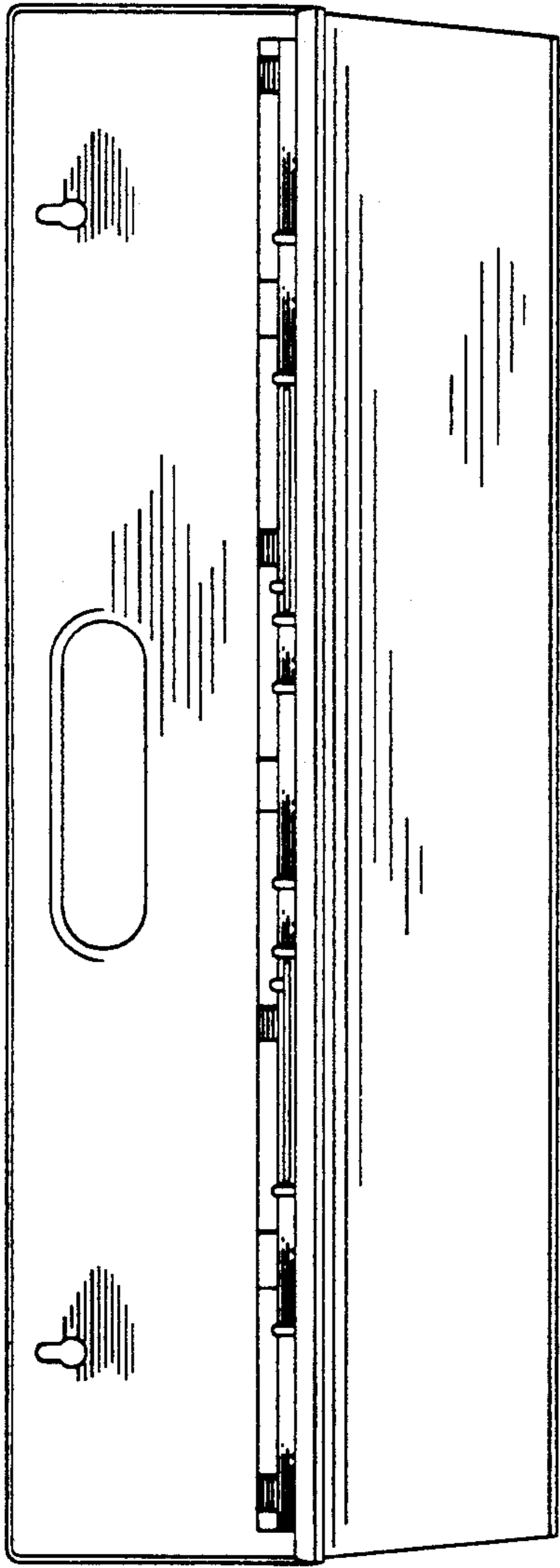

FIG. 12

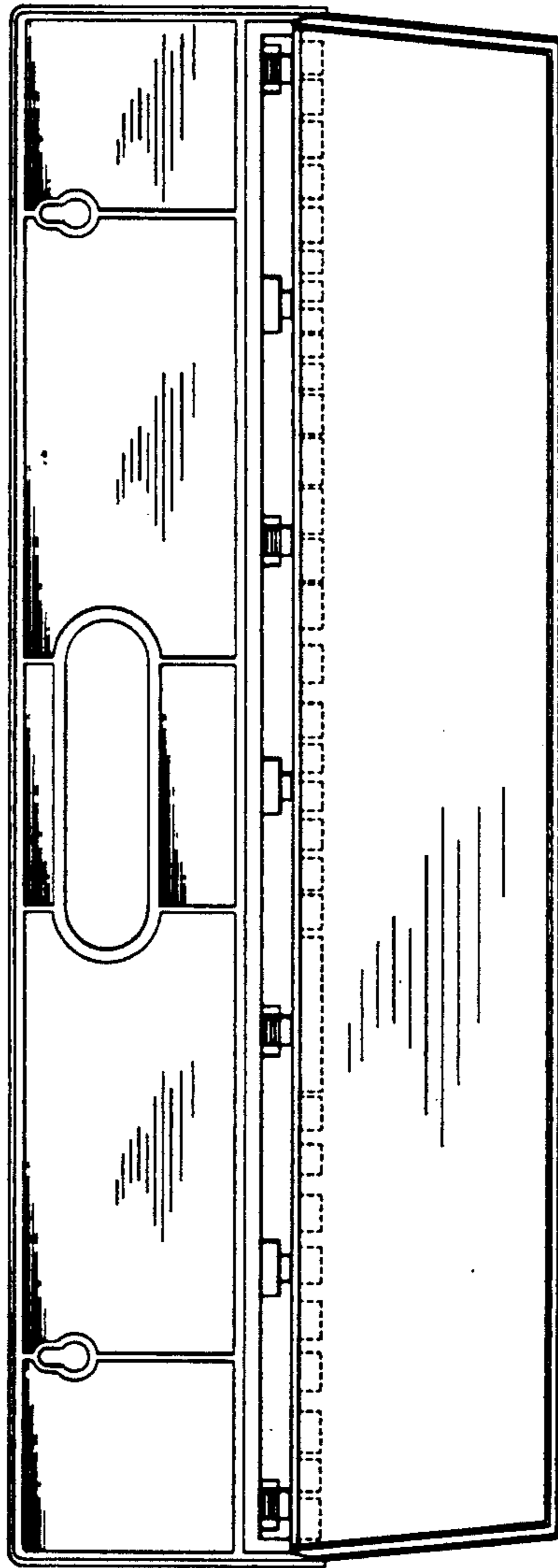

FIG. 13

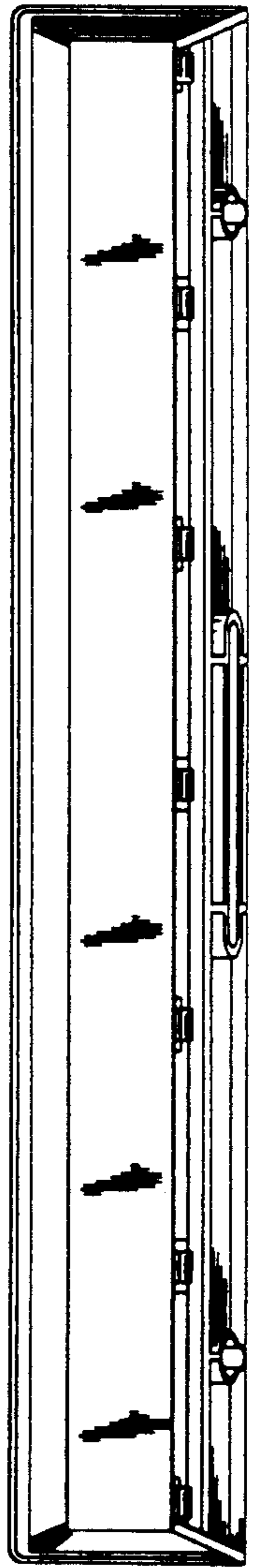

FIG. 15

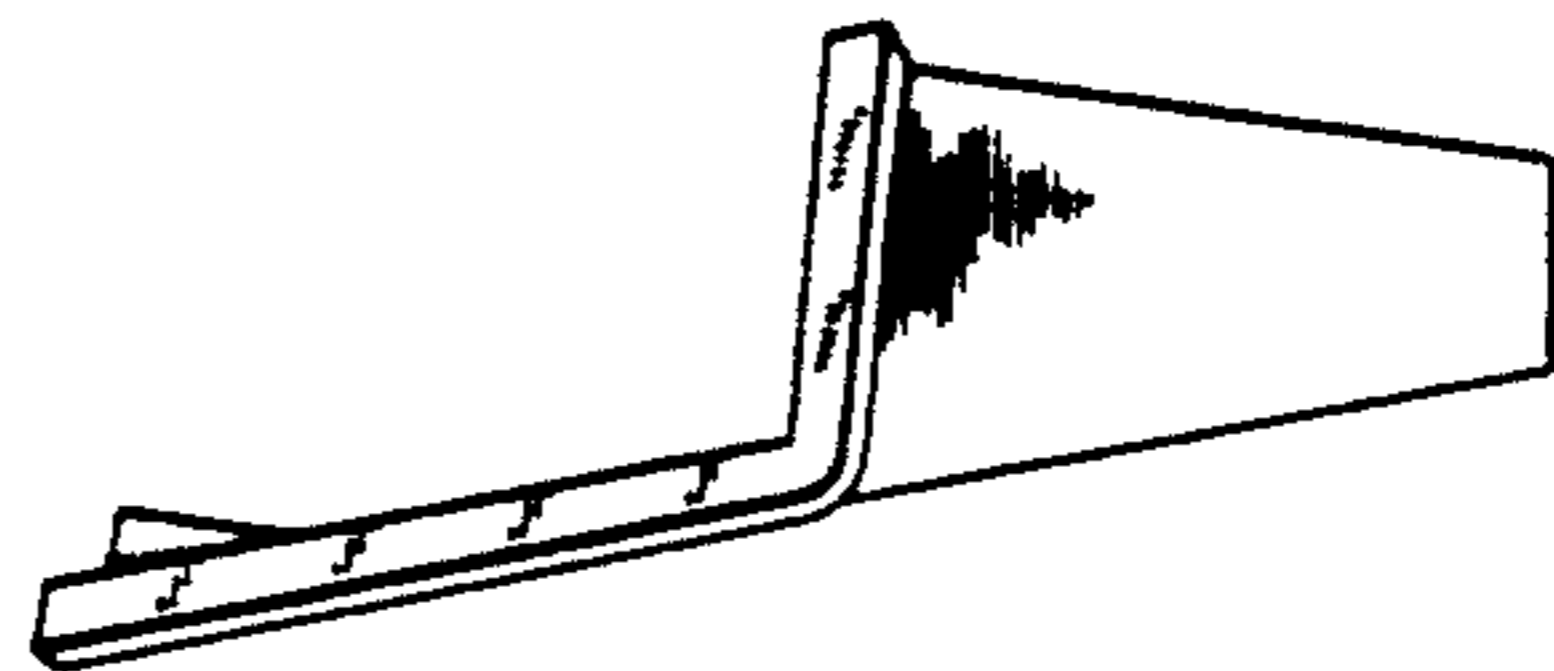

FIG. 14

Fig. 16

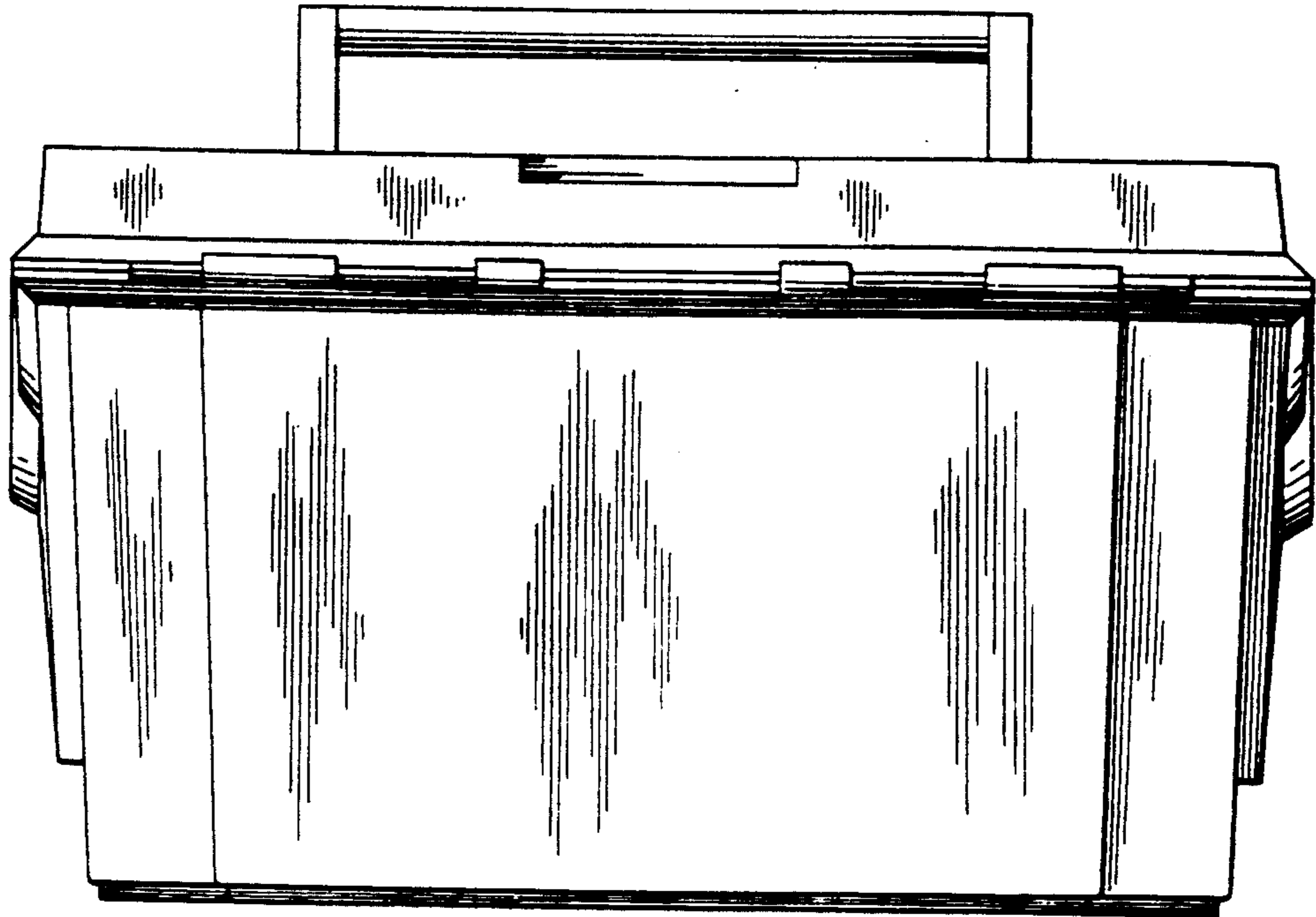
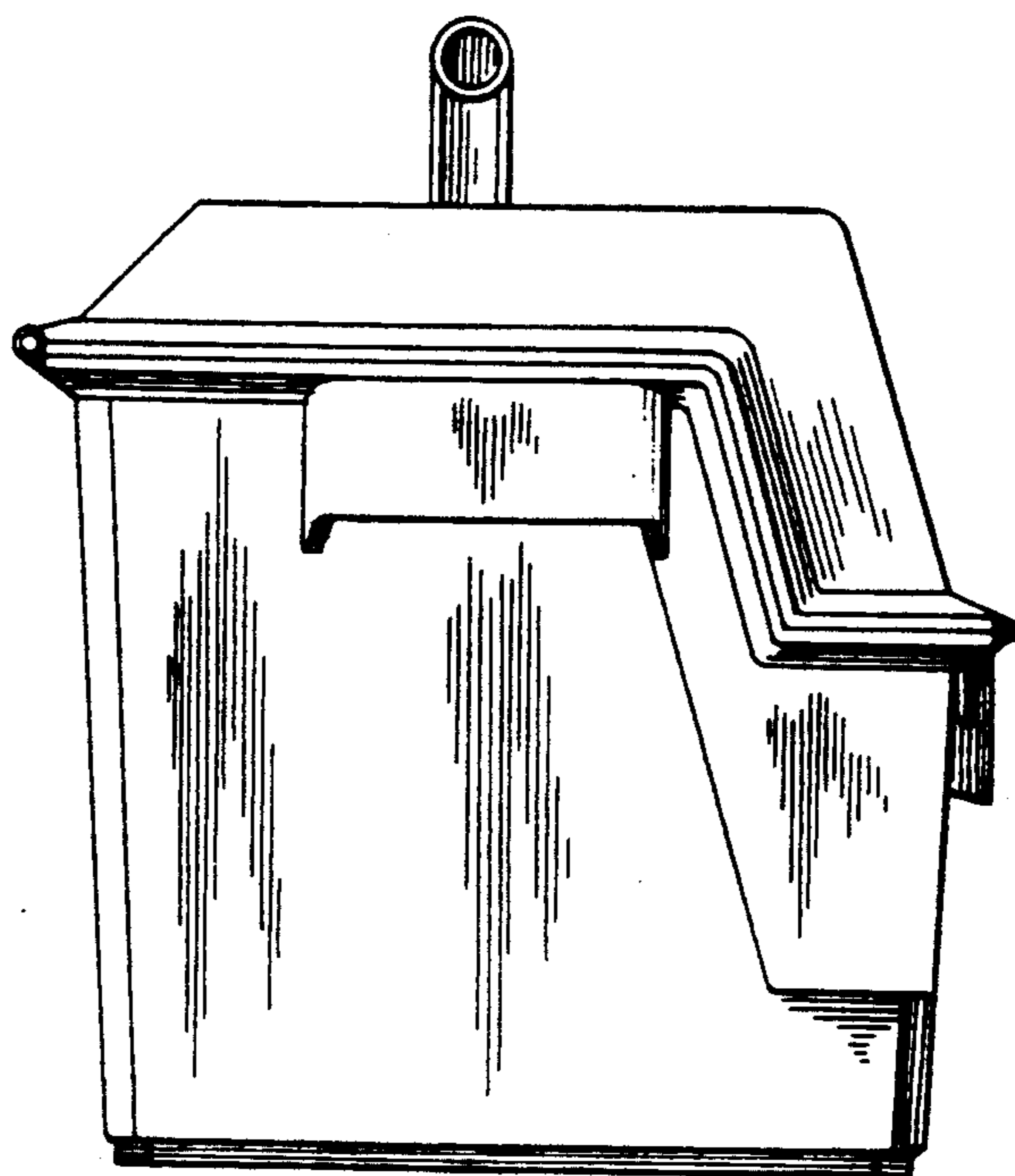

Fig. 17



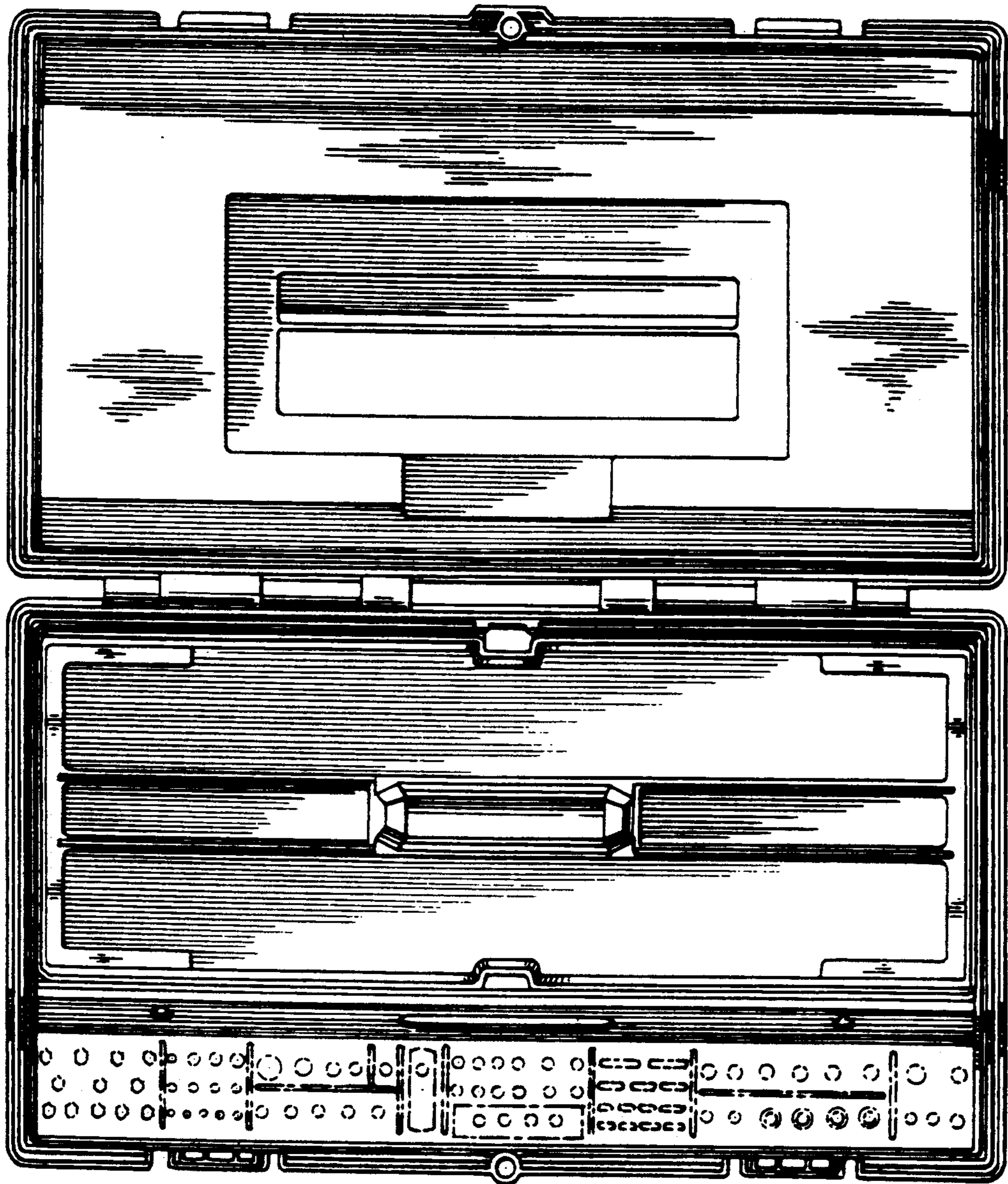
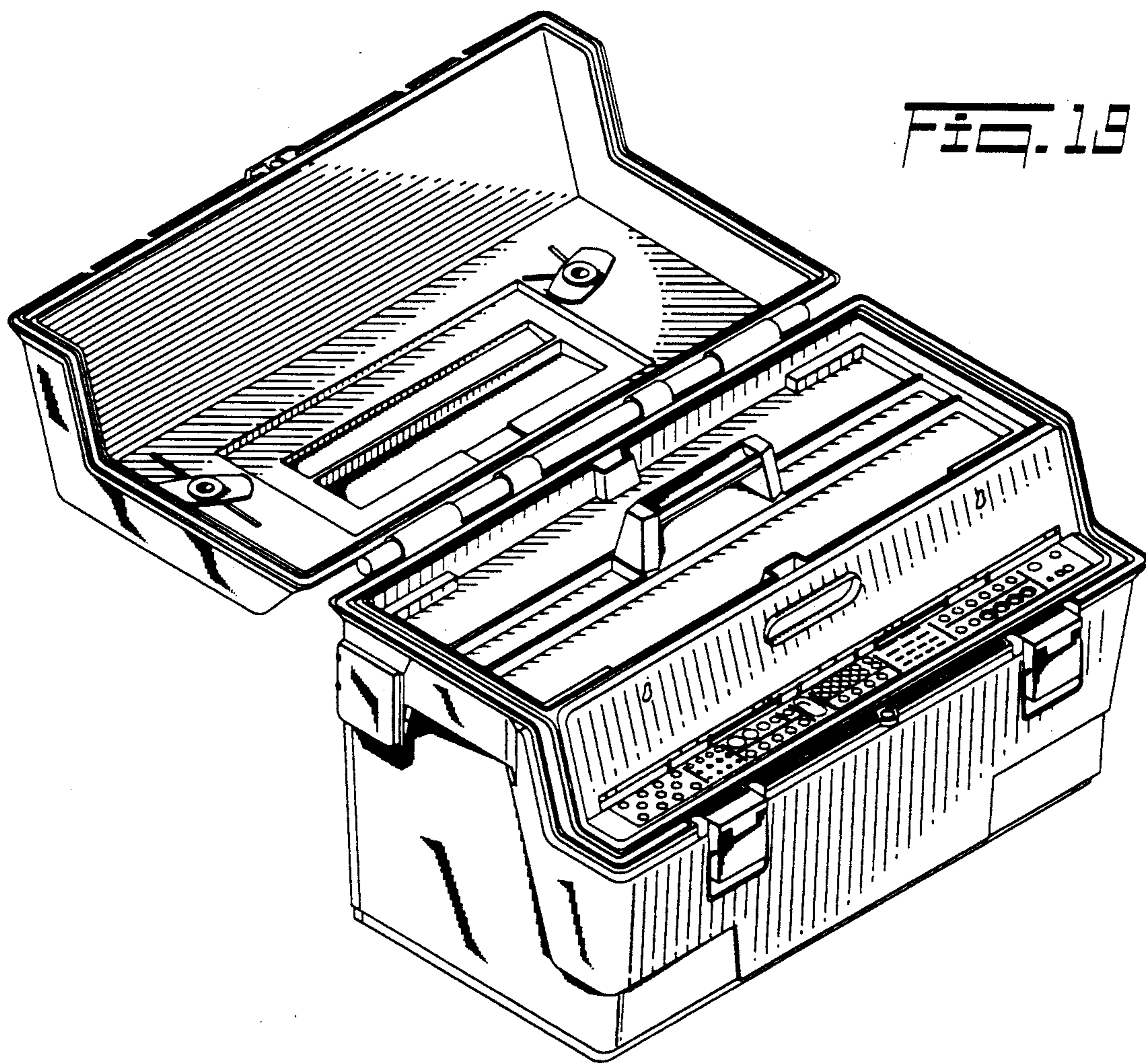

Fig. 1B



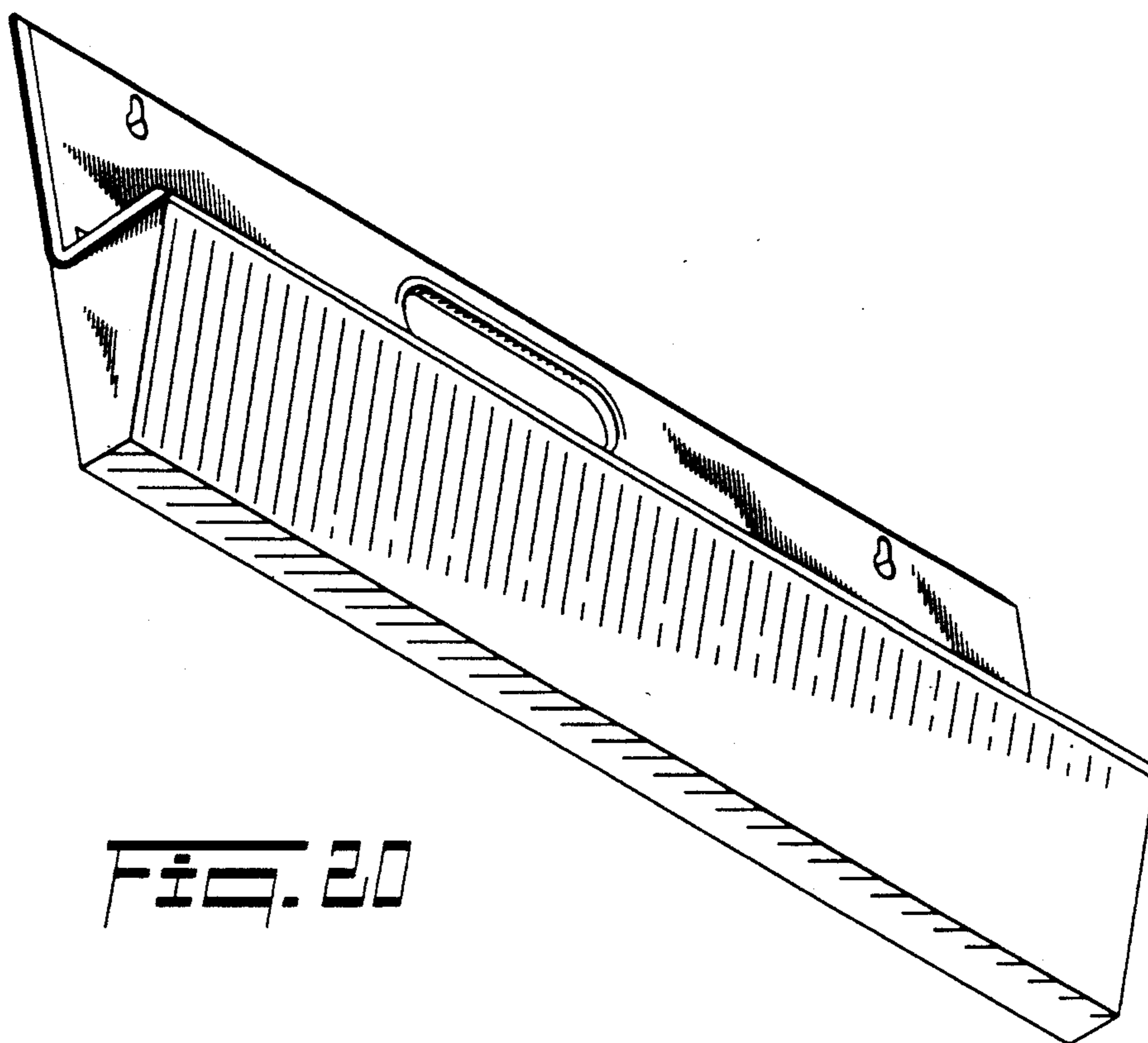

FIG. 20

FIG. 21

