



US00D332510S

# United States Patent [19]

[11] Patent Number: **Des. 332,510**

**Kovatch**

[45] Date of Patent: **\*\* Jan. 12, 1993**

- [54] FLOOR FOR ANIMALS
- [75] Inventor: **Henry Kovatch, Caracas, Venezuela**
- [73] Assignee: **Industrias Uniplasticas, S.A., Guatire, Venezuela**
- [\*\*] Term: **14 Years**
- [21] Appl. No.: **751,682**
- [22] Filed: **Aug. 29, 1991**
- [52] U.S. Cl. .... **D30/120**
- [58] Field of Search ..... **D30/108-109, D30/112-118, 120, 160; 119/28, 17; D34/40**

- 102599 9/1925 Fed. Rep. of Germany ..... 119/28
- 2840395 3/1980 Fed. Rep. of Germany ..... 119/28
- 346448 1/1905 France ..... 119/28

*Primary Examiner*—A. Hugo Word  
*Assistant Examiner*—Cathy Anne MacCormac  
*Attorney, Agent, or Firm*—Dennison, Meserole, Pollack & Scheiner

### [57] CLAIM

The ornamental design for a floor for animals, as shown and described.

### DESCRIPTION

FIG. 1 is a perspective view of a floor for animals, showing my new design;  
 FIG. 2 is a top plan view thereof;  
 FIG. 3 is a left side elevational view thereof;  
 FIG. 4 is an end elevational view thereof;  
 FIG. 5 is a bottom plan view thereof;  
 FIG. 6 is a right side elevational view;  
 FIG. 7 is an end elevational view thereof showing the opposite end of FIG. 4;  
 FIG. 8 is a fragmentary bottom perspective view thereof;  
 FIG. 9 is a cross sectional view thereof taken along line 9—9 of FIG. 2; and,  
 FIG. 10 is a cross sectional view thereof taken along line 10—10 of FIG. 2.

- [56] **References Cited**
- U.S. PATENT DOCUMENTS**
- |            |         |                      |         |
|------------|---------|----------------------|---------|
| D. 26,443  | 12/1896 | Fiske .....          | D30/120 |
| D. 318,148 | 7/1991  | Peltier .....        | D30/120 |
| 4,018,188  | 4/1977  | Burdette .....       | 119/28  |
| 4,048,960  | 9/1977  | Barnidge et al. .... | 119/28  |
| 4,182,271  | 1/1980  | Dodge et al. ....    | 119/28  |
| 4,235,197  | 11/1980 | Curtis et al. ....   | 119/28  |
| 4,356,792  | 11/1982 | Leverett .....       | 119/28  |
| 4,362,128  | 12/1982 | Downey .....         | 119/28  |
| 4,387,666  | 6/1983  | Thye-Lokenberg ..... | 119/28  |
- FOREIGN PATENT DOCUMENTS**
- |       |        |                         |        |
|-------|--------|-------------------------|--------|
| 81736 | 6/1983 | European Pat. Off. .... | 119/28 |
|-------|--------|-------------------------|--------|

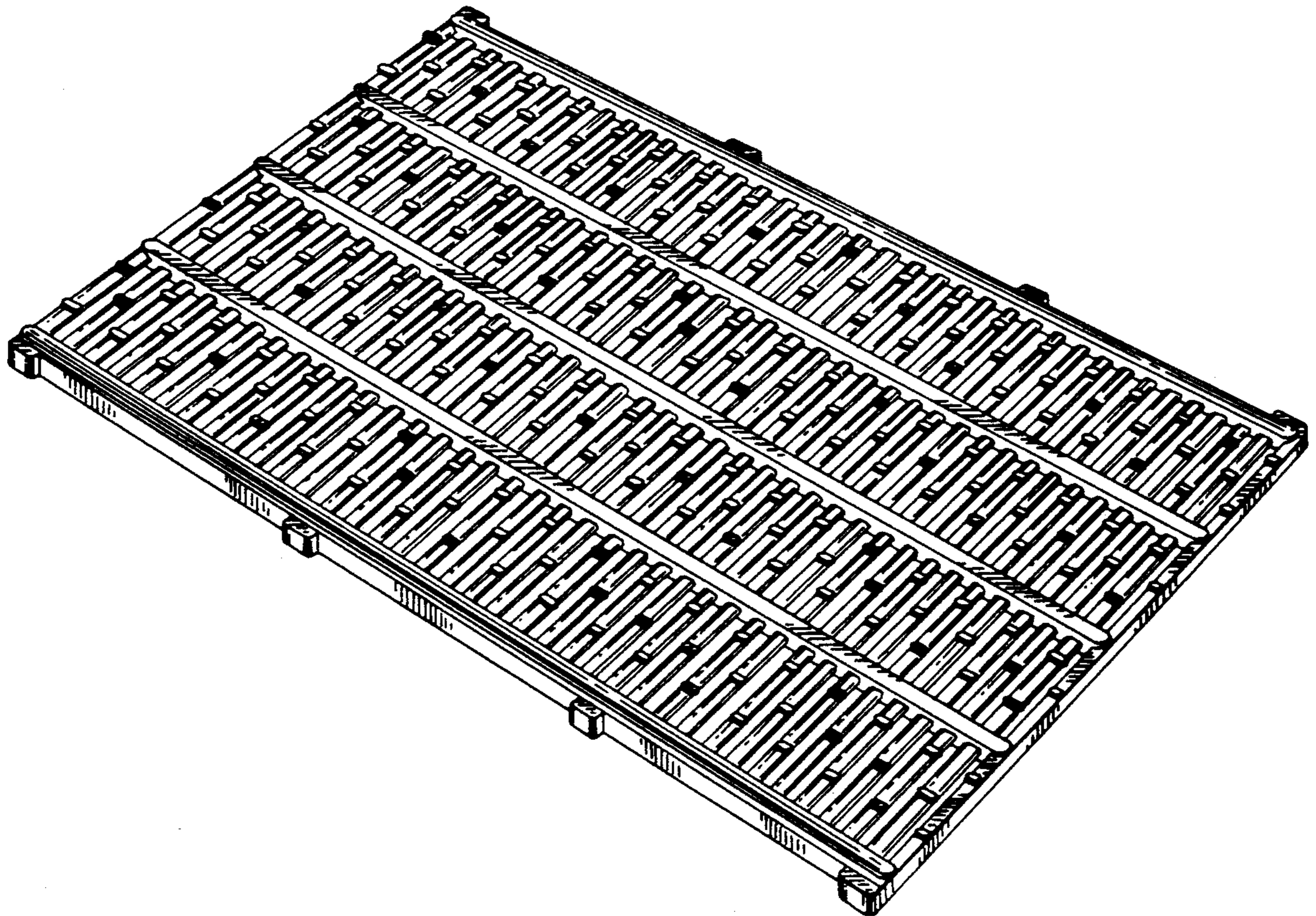

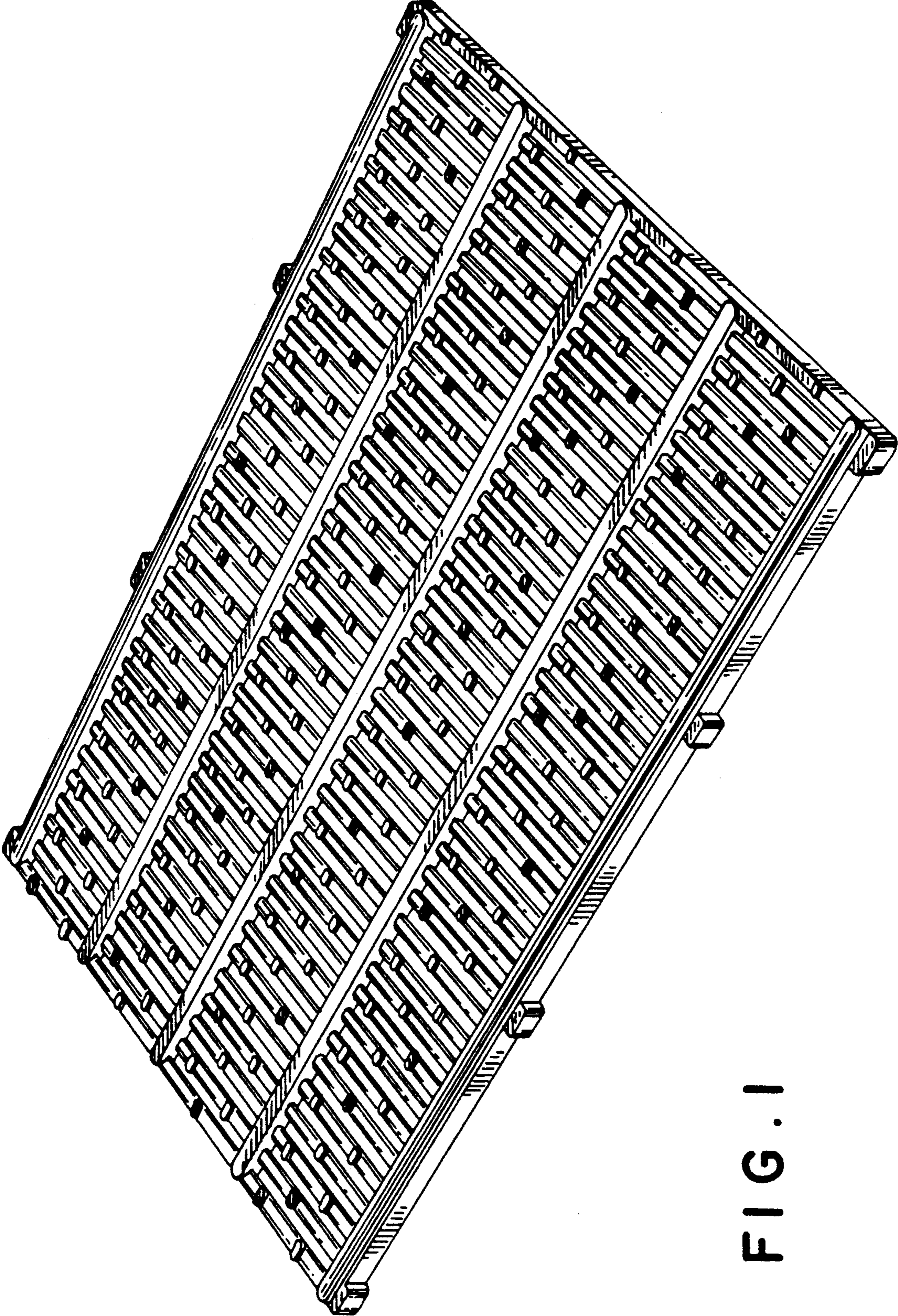

FIG. 1

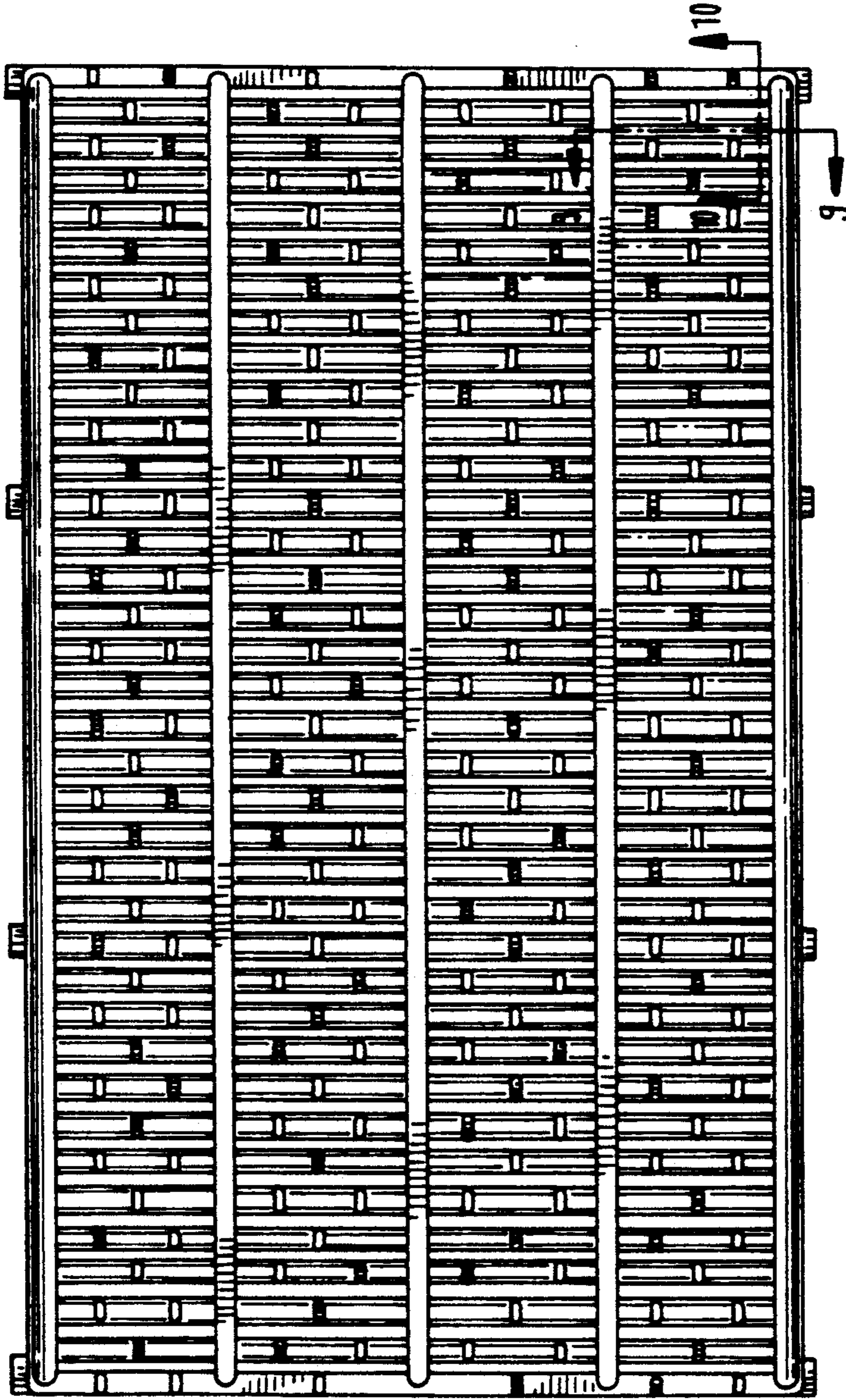

FIG. 2

FIG. 3



FIG. 4



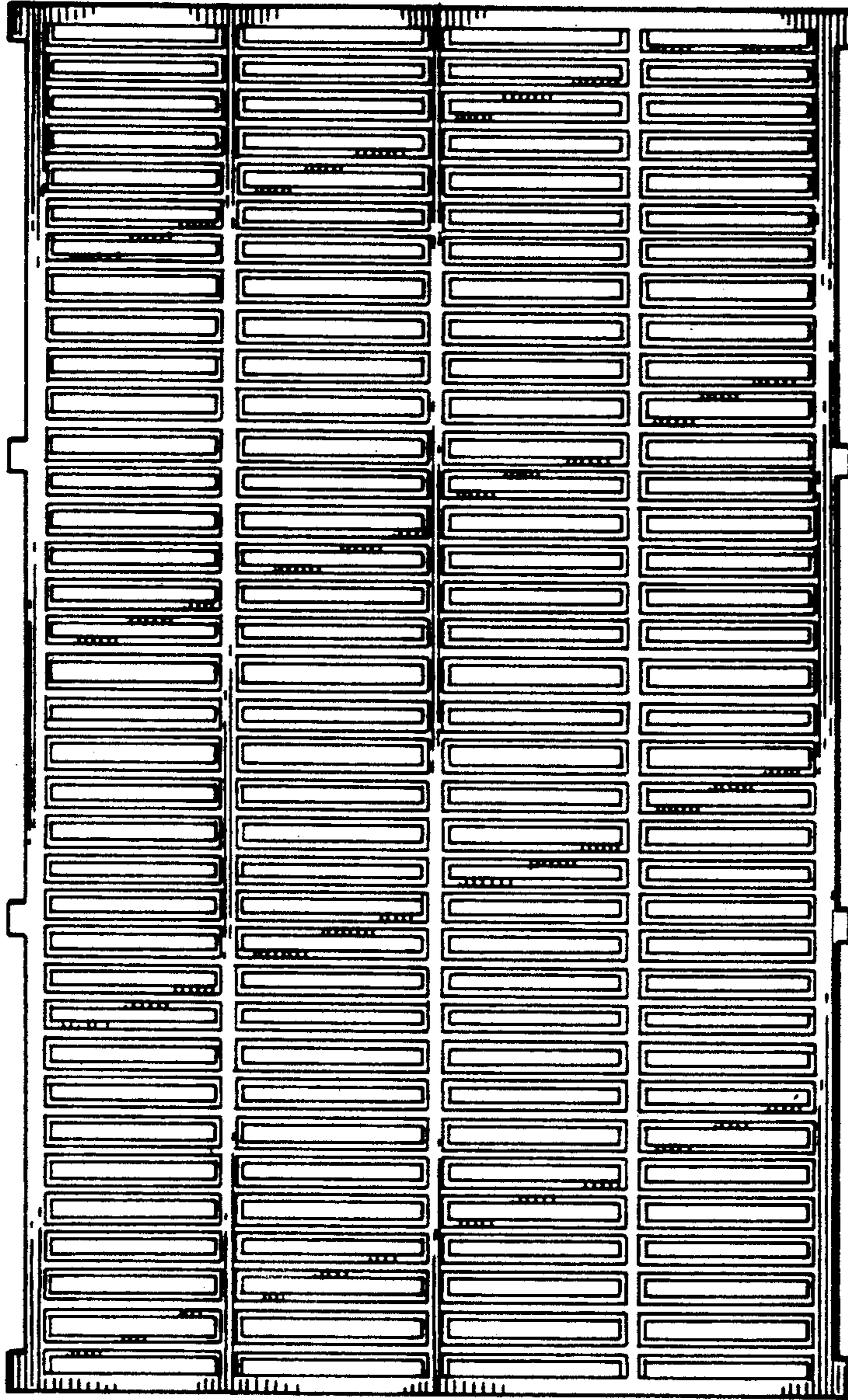

FIG. 5

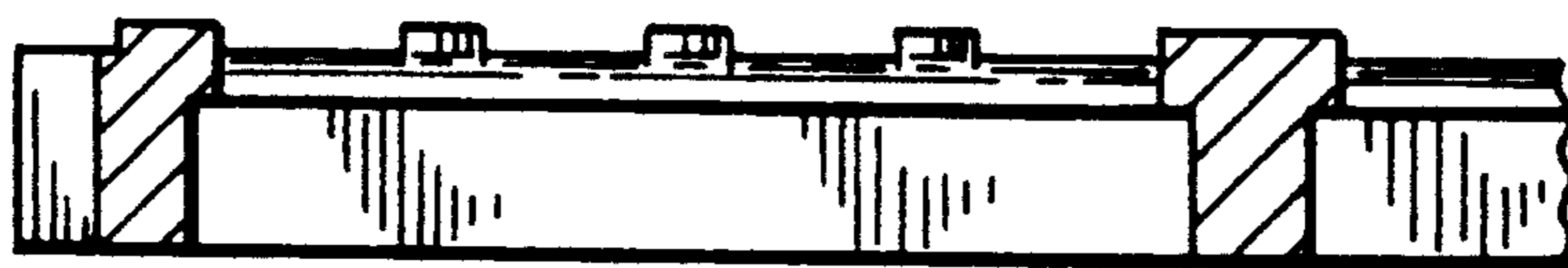
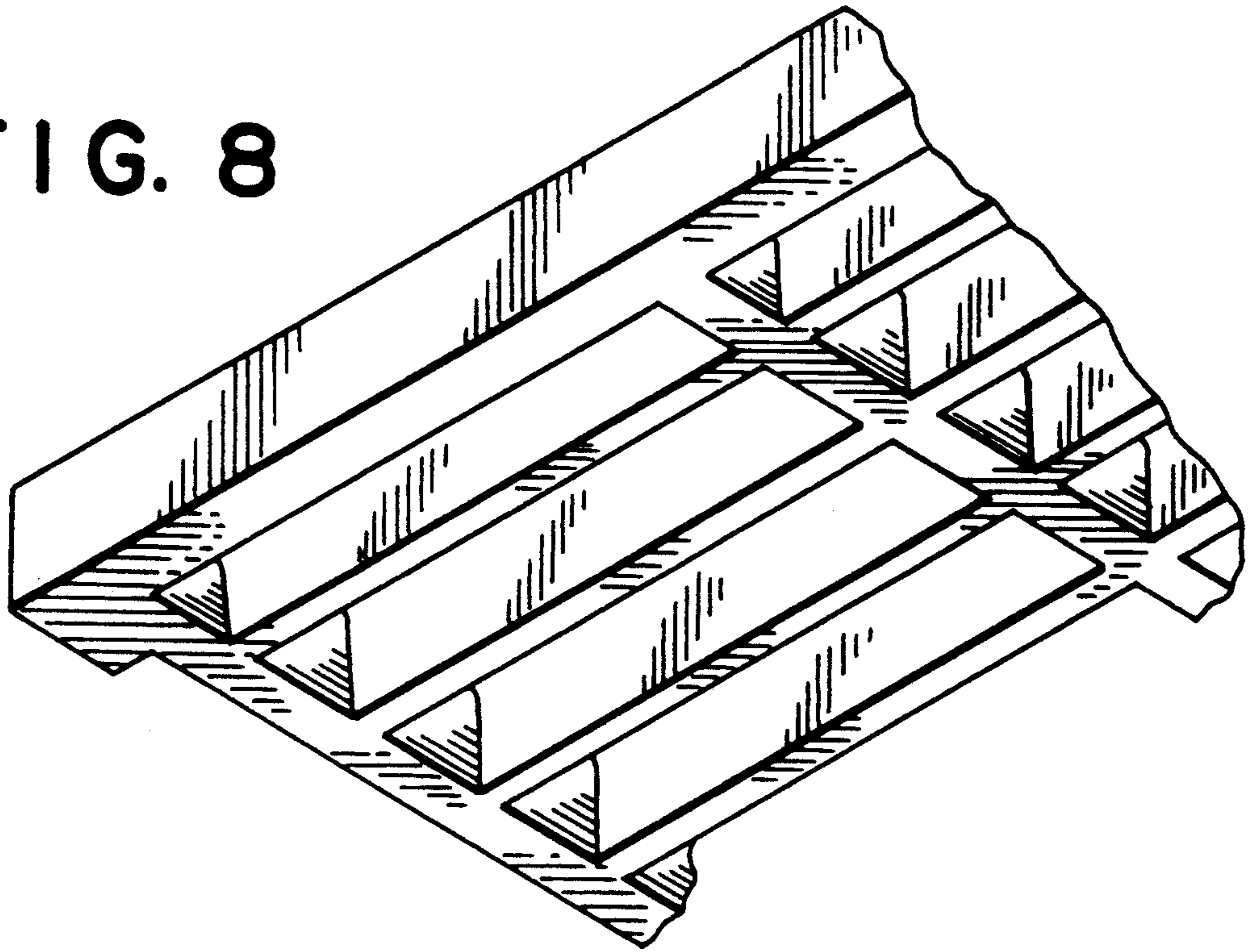

FIG. 6

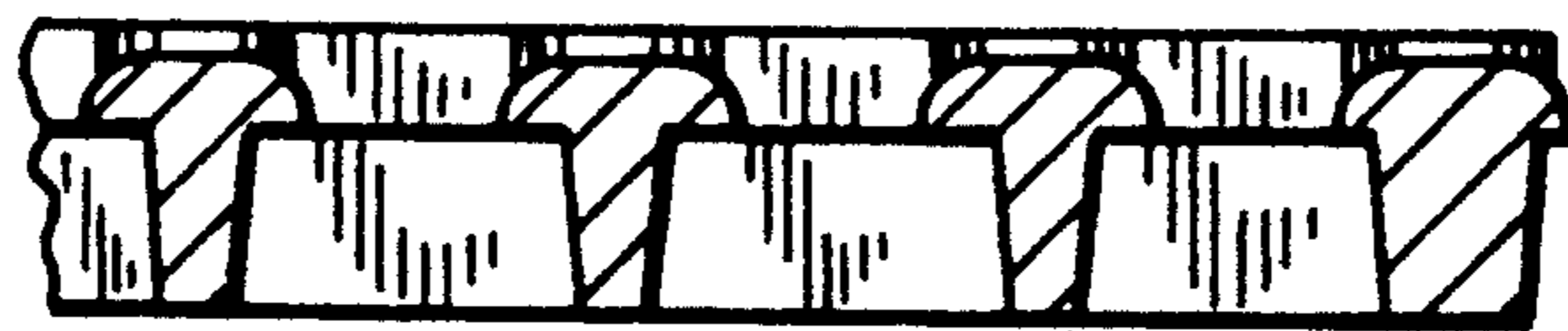

FIG. 7

**FIG. 8**



**FIG. 9**



**FIG. 10**

UNITED STATES PATENT AND TRADEMARK OFFICE  
**CERTIFICATE OF CORRECTION**

PATENT NO. : Des.332,510  
DATED : January 12, 1993  
INVENTOR(S) : Henry Kovatch

It is certified that error appears in the above-identified patent and that said Letters Patent is hereby corrected as shown below:

On the Title page, under Description:

FIG. 4 is a right side elevational view thereof;

FIG. 6 is an end elevational view thereof;

FIG. 7 is an end elevational view thereof showing the opposite end of Fig. 6;

Signed and Sealed this  
Twenty-first Day of December, 1993

Attest:



BRUCE LEHMAN

Attesting Officer

Commissioner of Patents and Trademarks