



US00D332504S

# United States Patent [19]

Ewing et al.

[11] Patent Number: Des. 332,504

[45] Date of Patent: \*\* Jan. 12, 1993

[54] LUMINAIRE

D. 294,976 3/1988 Ewing ..... D26/85  
D. 298,862 12/1988 Tharp et al. .... D26/88

[75] Inventors: Robert L. Ewing, Licking; Peter A. Koloski, Columbus; Robert J. Hayes, Gahanna; Richard J. Malecha, Delaware; David G. Meredith, Westerville, all of Ohio

OTHER PUBLICATIONS

Holophane Lighting Catalog, Dec. 1987, p. 5, "Prismalume" Light Fixture.  
Thomas Lighting "Lighting Classics" Catalog ©1985, p. 35, Steelite II Light Fixture.

[73] Assignee: Holophane Company, Inc., Newark, Ohio

Primary Examiner—Susan J. Lucas

[\*\*] Term: 14 Years

[57] CLAIM

[21] Appl. No.: 513,333

The ornamental design for a luminaire, as shown and described.

[22] Filed: Apr. 20, 1990

DESCRIPTION

[52] U.S. Cl. .... D26/88

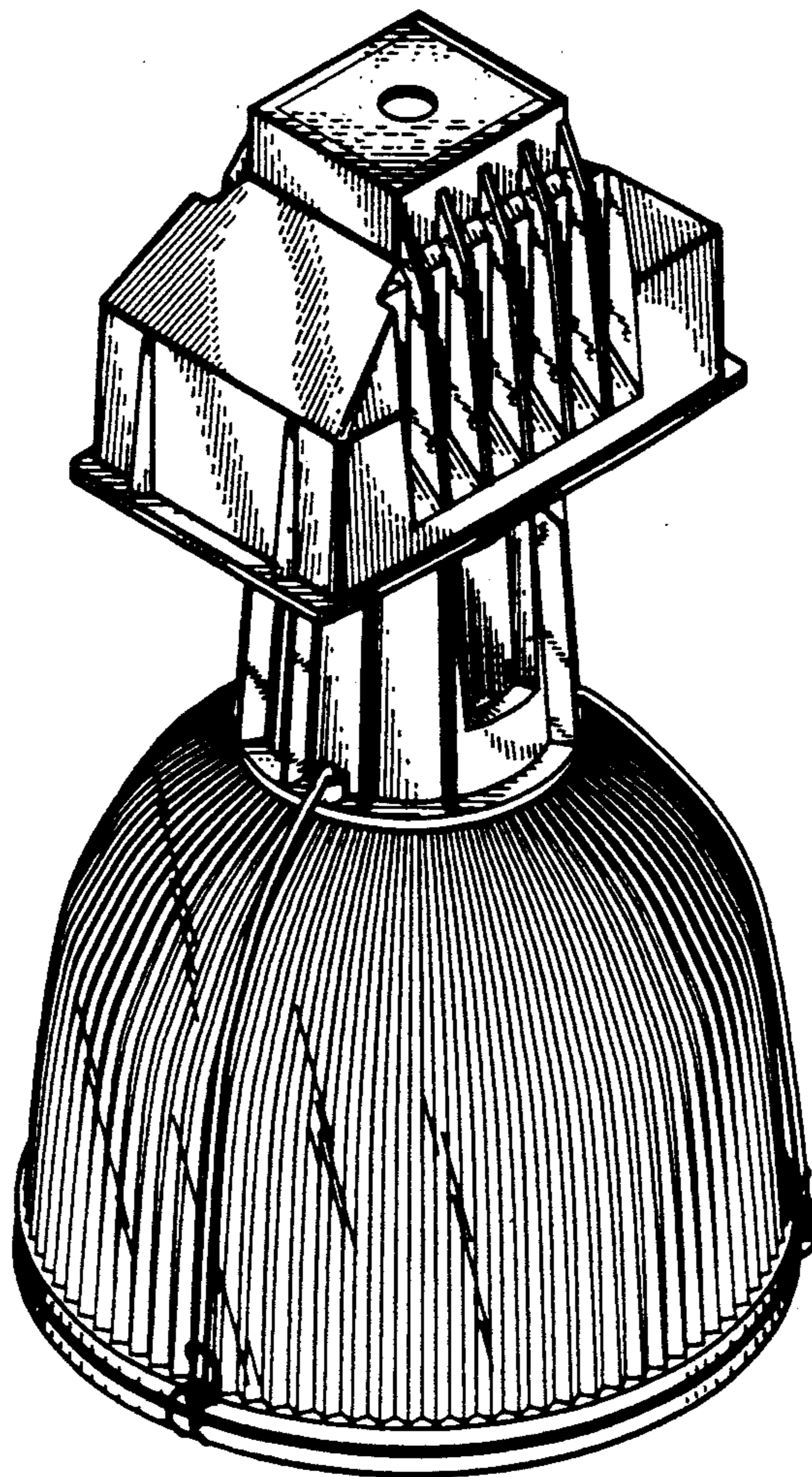
[58] Field of Search ..... D26/72, 80-92;  
362/147, 404-408, 362, 432, 222, 223

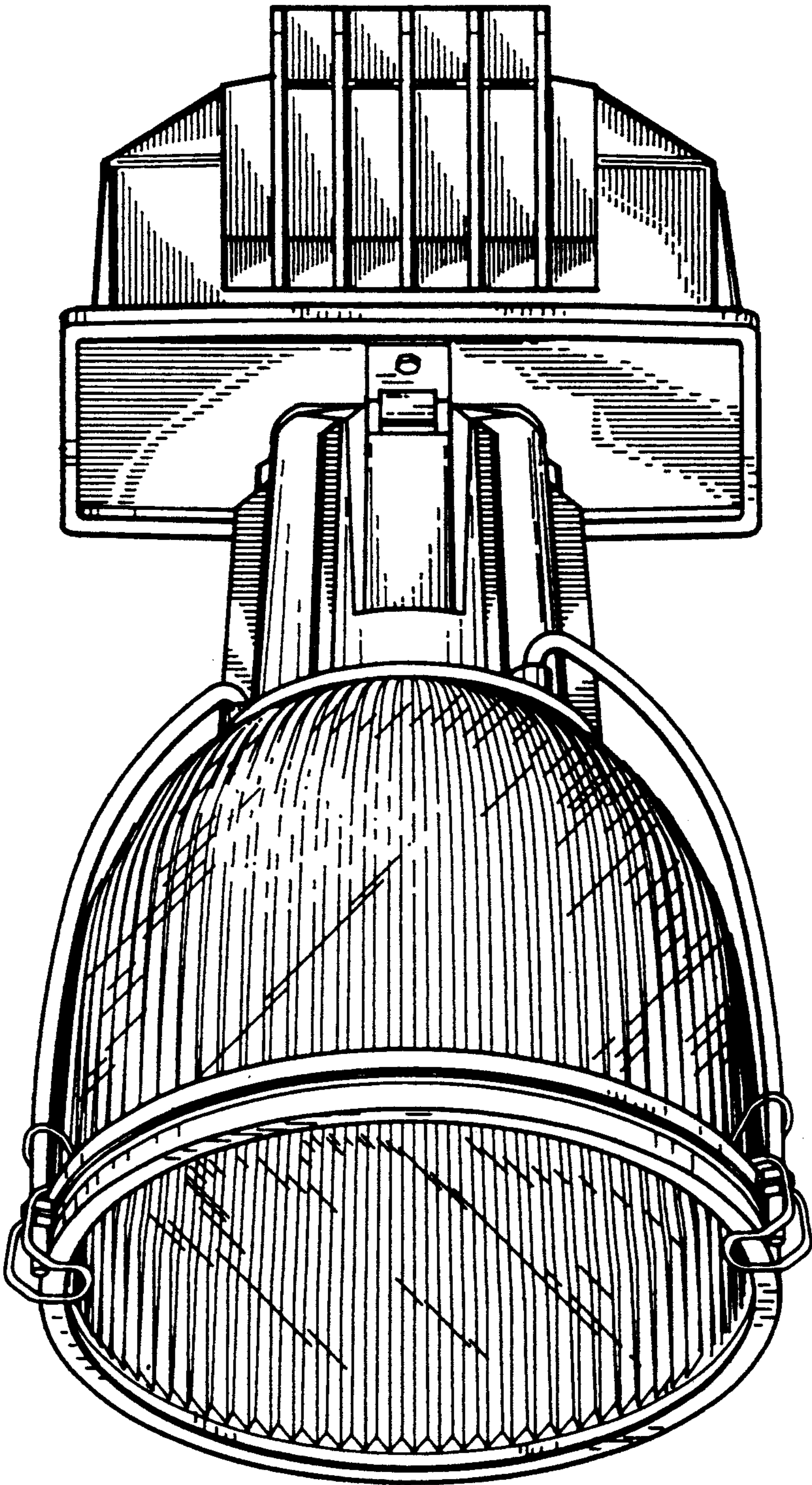
FIG. 1 is a bottom, front perspective view of a luminaire showing our new design;  
FIG. 2 is a rear elevational view thereof;  
FIG. 3 is a side elevational view thereof, the opposite side being a mirror image;  
FIG. 4 is a bottom plan view thereof;  
FIG. 5 is a top plan view thereof;  
FIG. 6 is a side, rear perspective view thereof; and,  
FIG. 7 is a side, front perspective view thereof.

[56] References Cited

U.S. PATENT DOCUMENTS

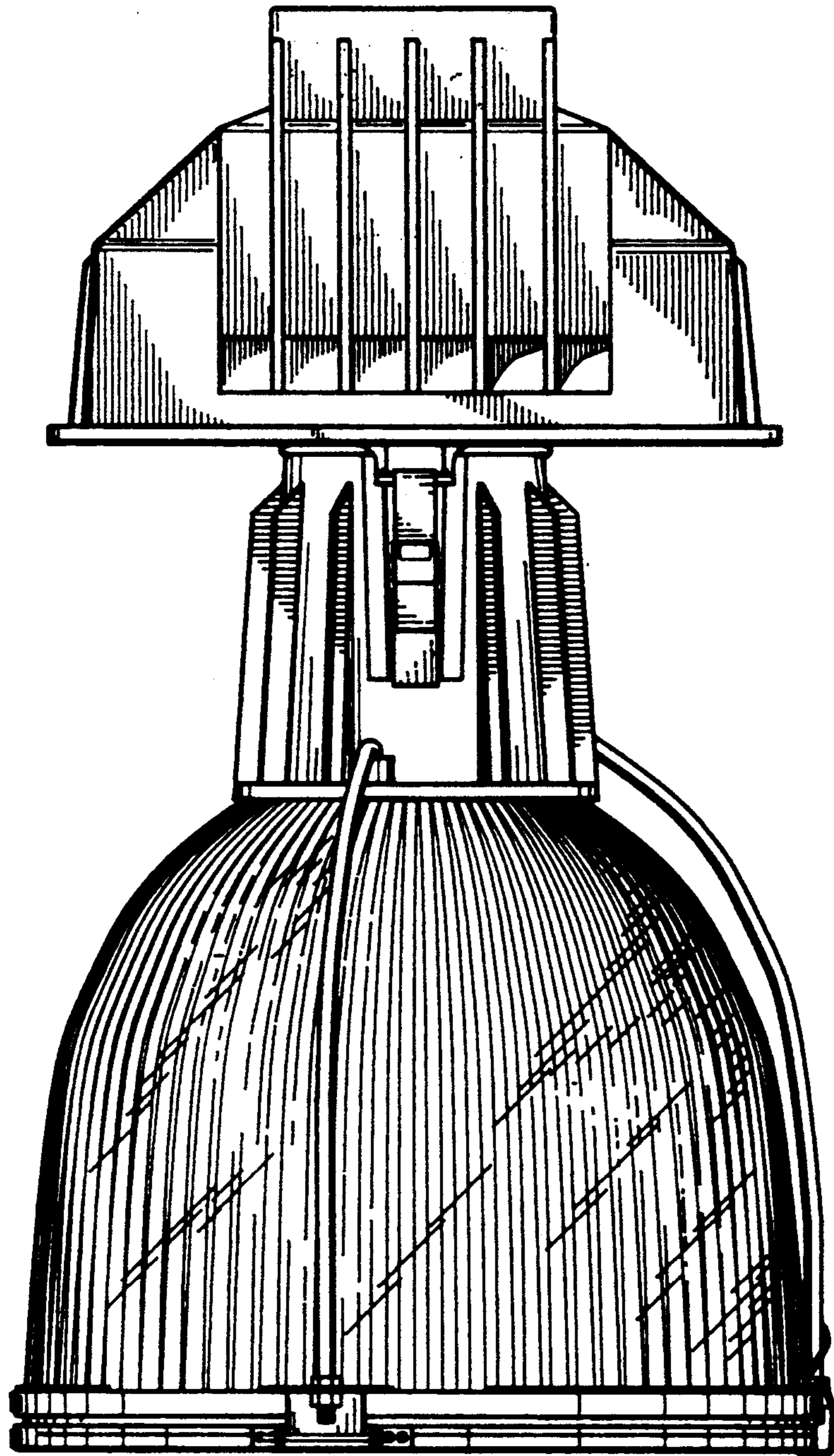
D. 207,414 4/1967 Lum et al. .... D26/88  
D. 268,876 5/1983 Leithauser, Jr. .... D26/72  
D. 269,639 7/1983 Eargle, Jr. et al. .... D26/88



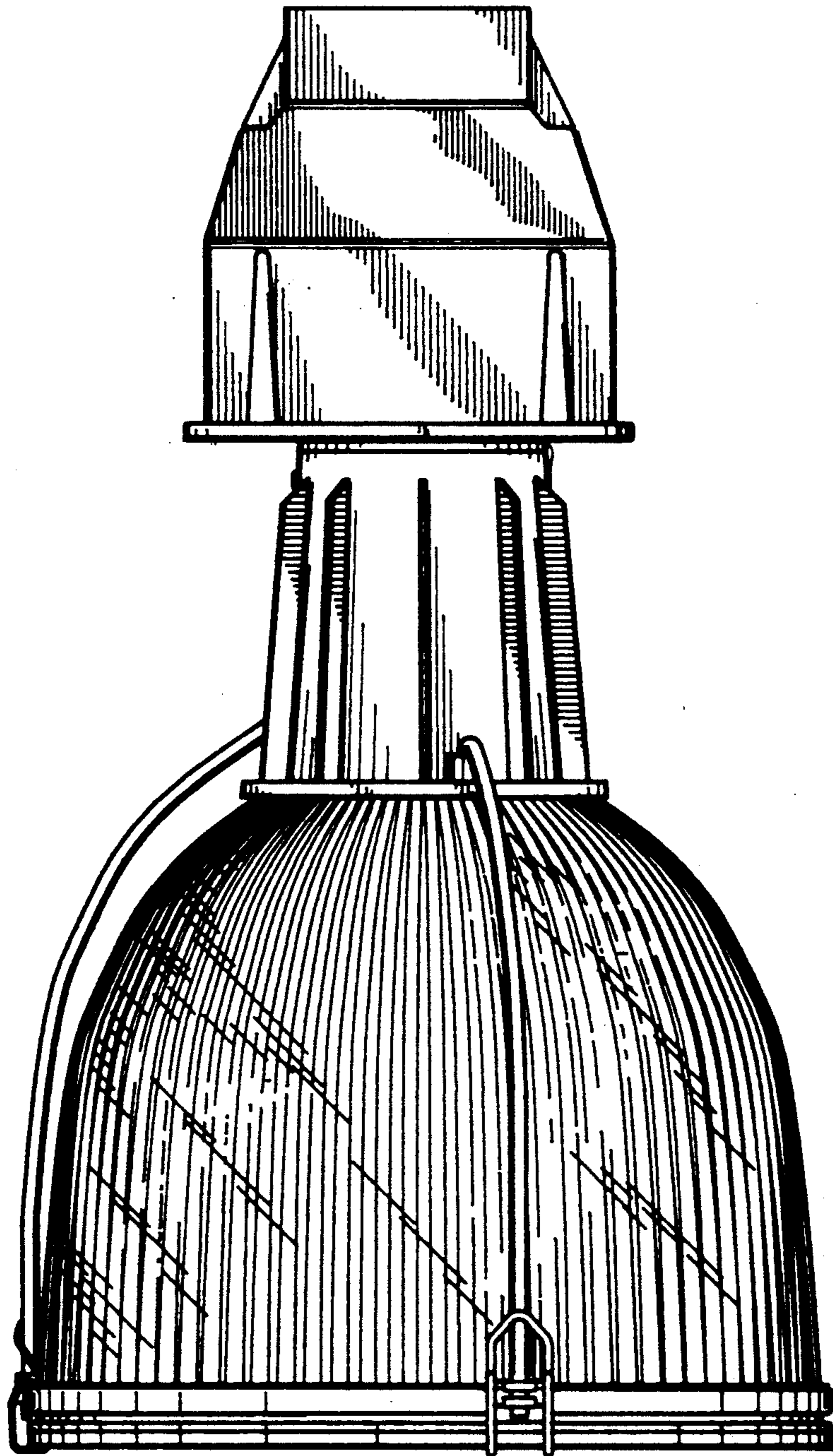


*Fig. 1*



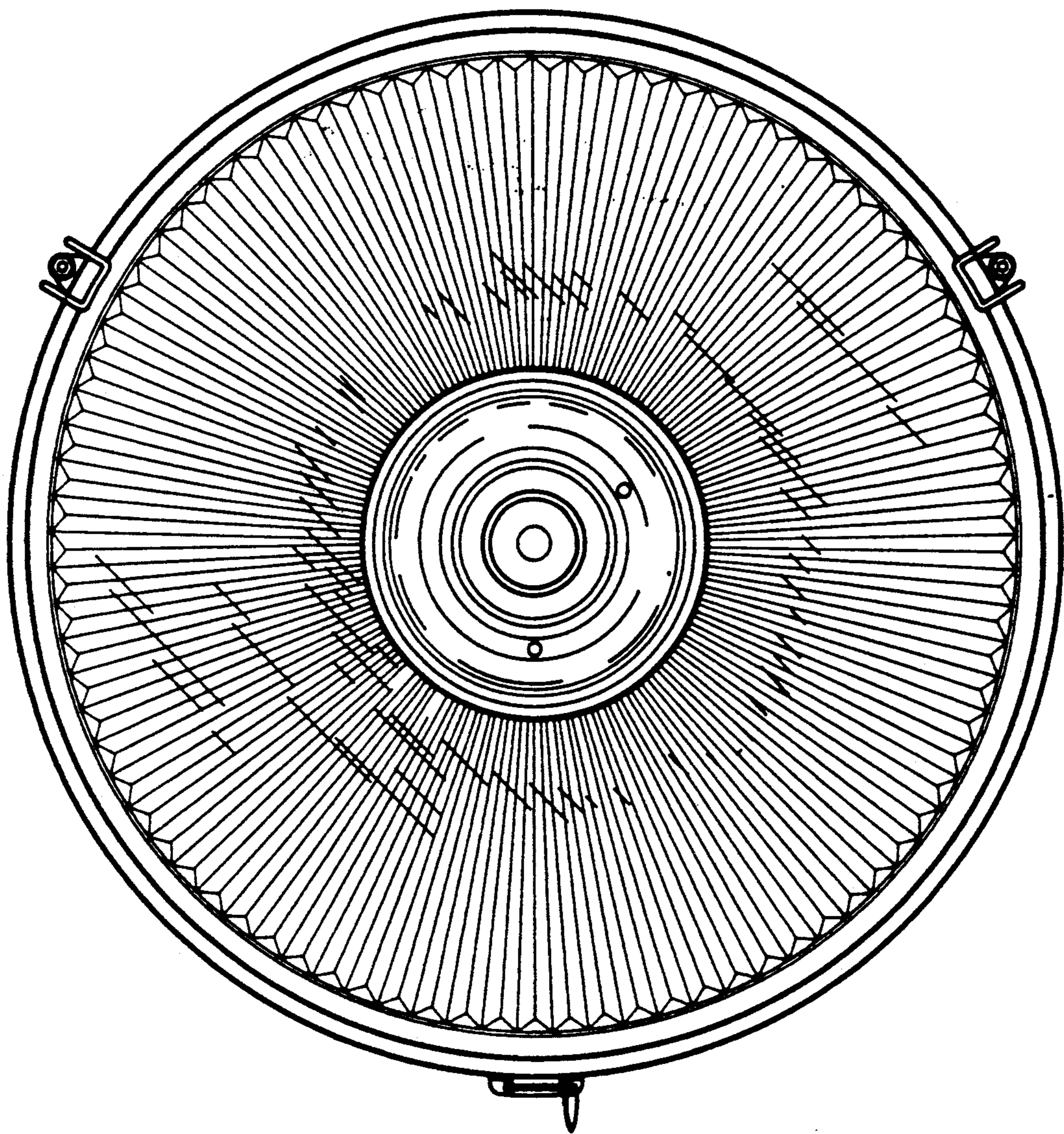


*Fig. 2*

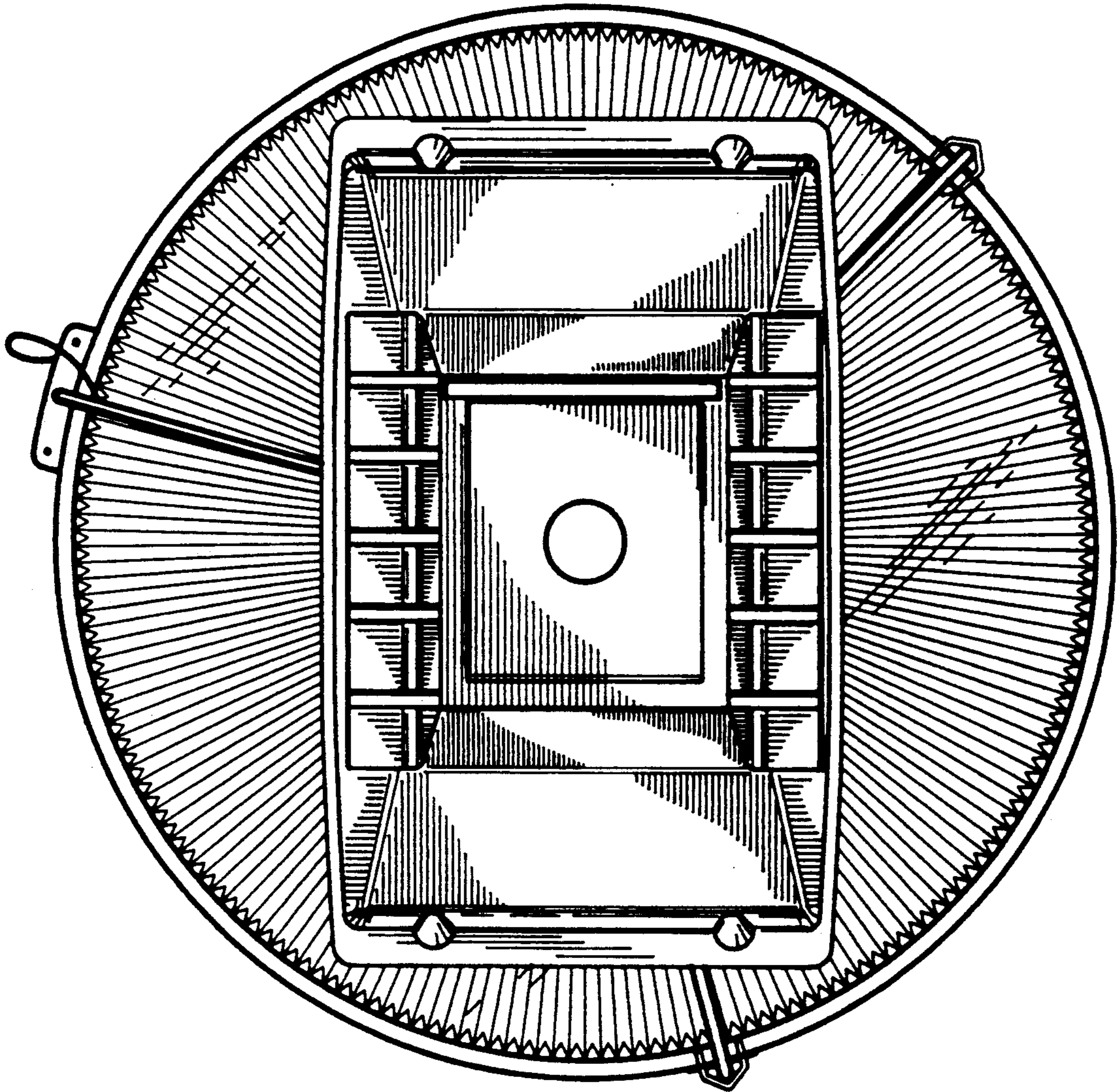


*Fig. 3*



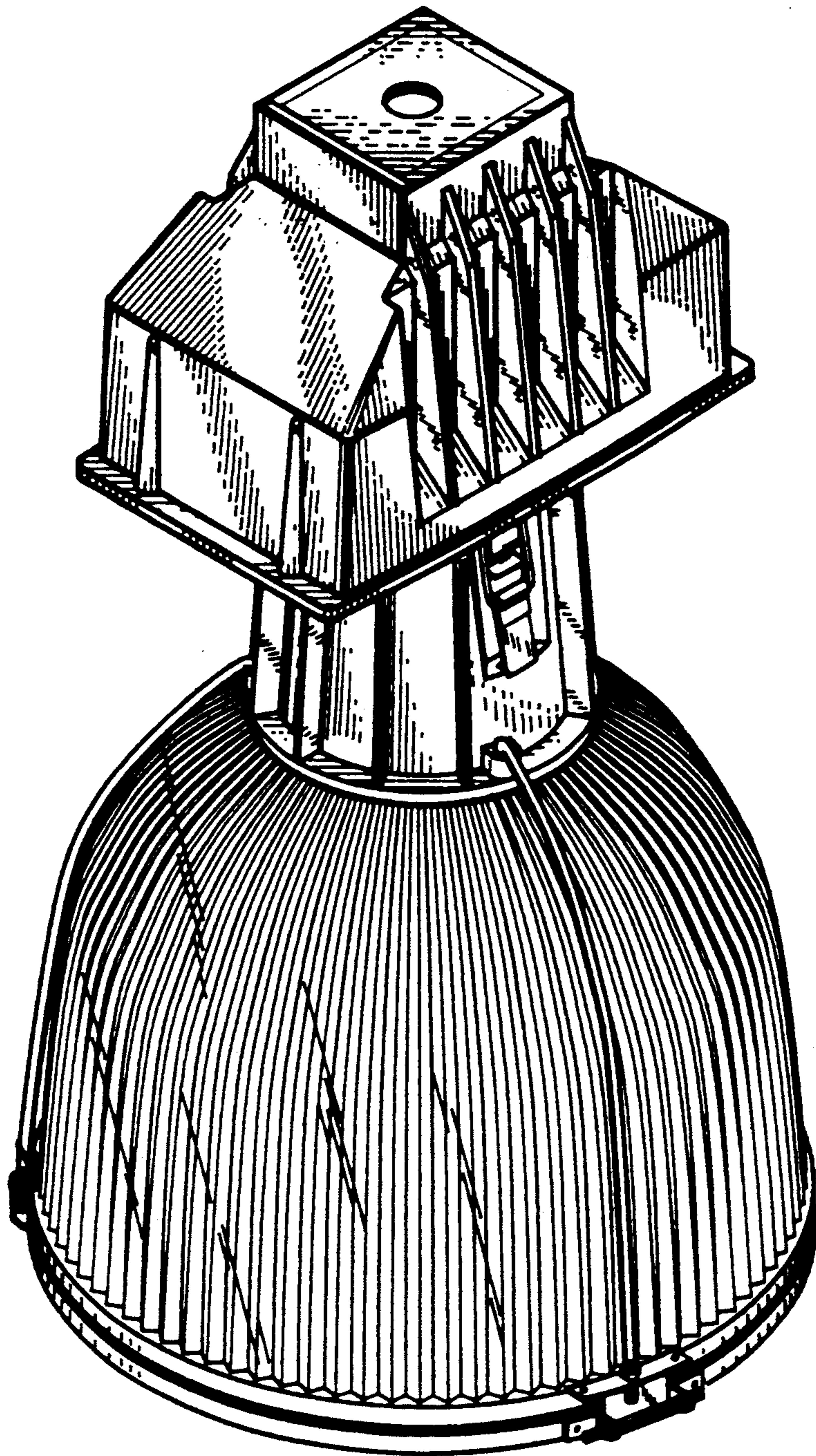


*Fig. 4*

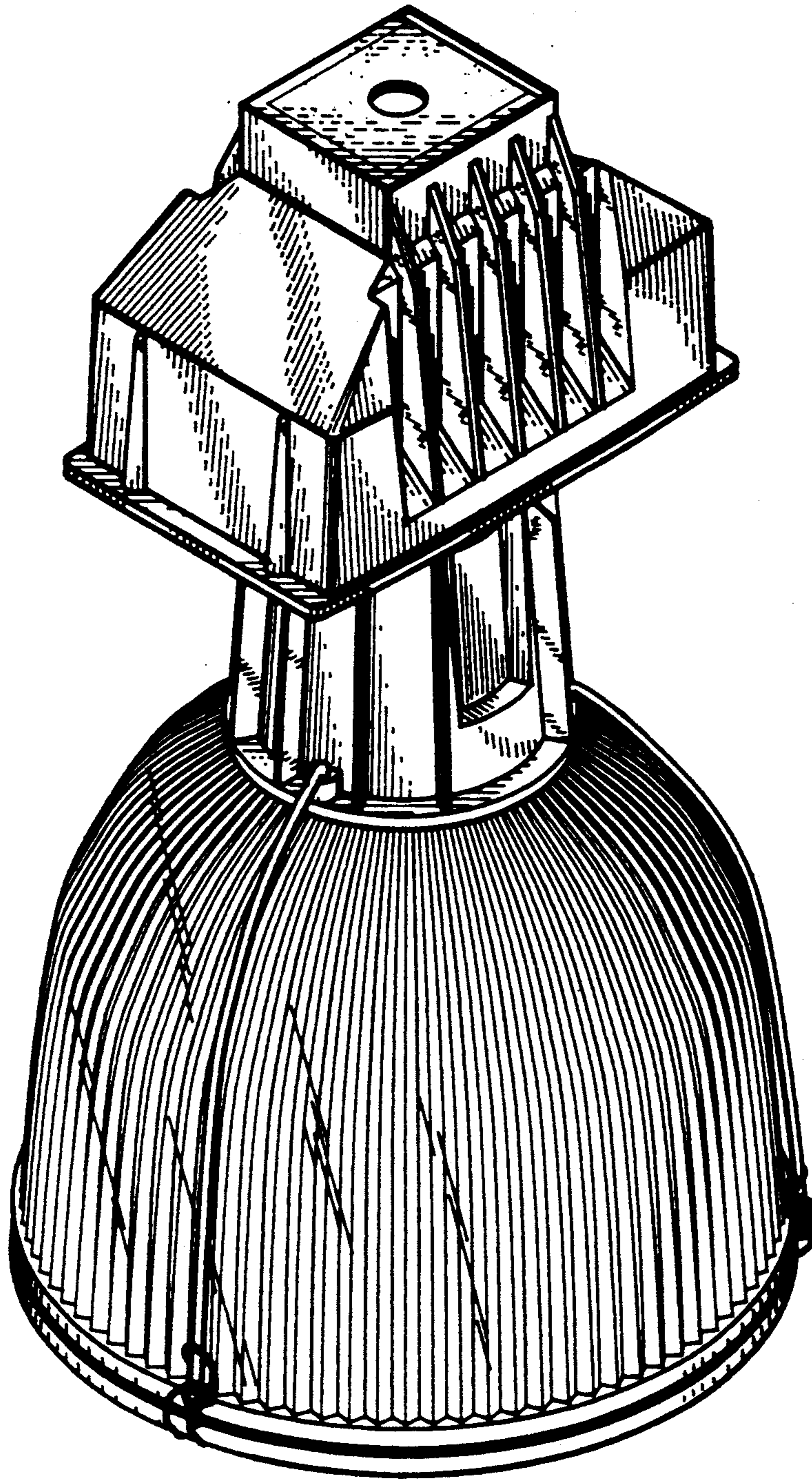


*Fig. 5*





*Fig. 6*



*Fig. 7*