



US00D332368S

United States Patent [19]

[11] Patent Number: Des. 332,368

Hines et al.

[45] Date of Patent: ** Jan. 12, 1993

[54] **FLUID DISPENSER**

[75] Inventors: **David M. Hines**, Tustin; **Emmanuel A. Hanna**, Lakeview Terrace, both of Calif.

[73] Assignee: **Bobrick Washroom Equipment, Inc.**, North Hollywood, Calif.

[**] Term: **14 Years**

[21] Appl. No.: **723,529**

[22] Filed: **Jul. 1, 1991**

[52] U.S. Cl. **D6/545**

[58] Field of Search **D6/542-545;**
4/628, 630; 221/282-286; 222/123, 180-181,
185; 312/245

[56] **References Cited**

U.S. PATENT DOCUMENTS

D. 200,206	2/1965	Arkwright .	
D. 245,889	9/1977	Cassia	D6/545
D. 279,530	7/1985	von Buelow	D6/545
D. 285,272	8/1986	Bunschoten et al.	D6/545
D. 285,887	9/1986	Palka .	
D. 293,746	1/1988	Sayward .	
D. 302,917	8/1989	Banks	D6/545
D. 312,184	11/1990	DeLuca et al.	D6/545
1,686,831	10/1928	Matchette .	
1,800,826	4/1931	Feltault .	
2,645,100	7/1953	Bascom .	

4,076,350	2/1978	Crist .	
4,105,146	8/1978	Broillard	222/181
4,130,224	2/1978	Norman et al.	222/185
4,558,472	12/1985	Fromme et al. .	

OTHER PUBLICATIONS

Bobrick Toilet and Bath Accessories catalog, Jan., 1991, pp. 12, 13.
American Specialties, Inc. brochure, Quality Wash-room Accessories, Series 9000, 4 pages (undated).
Bradley sheet No. 18 (undated).

Primary Examiner—Brian N. Vinson
Attorney, Agent, or Firm—Harris, Kern, Wallen & Tinsley

[57] **CLAIM**

The ornamental design for a fluid dispenser, as shown and described.

DESCRIPTION

FIG. 1 is a top, front, and left side perspective view of a fluid dispenser housing showing our new design; FIG. 2 is a front elevational view thereof; FIG. 3 is a left side elevational view thereof; FIG. 4 is a right side elevational view thereof; FIG. 5 is a top plan view thereof; FIG. 6 is a bottom plan view thereof; FIG. 7 is a rear elevational view thereof; and, FIG. 8 is a top, rear, and left side perspective view thereof, with the top cover and wall mount removed.

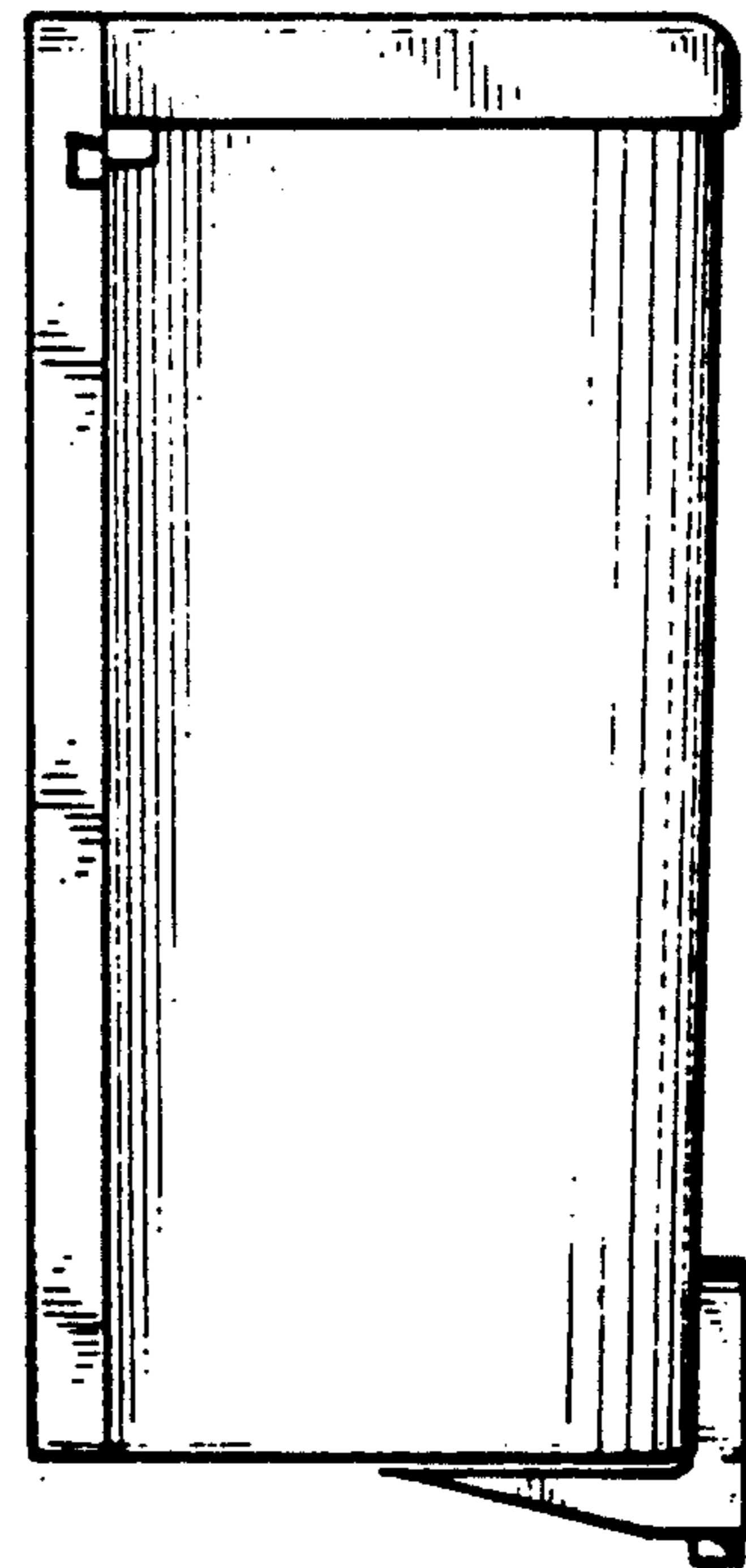
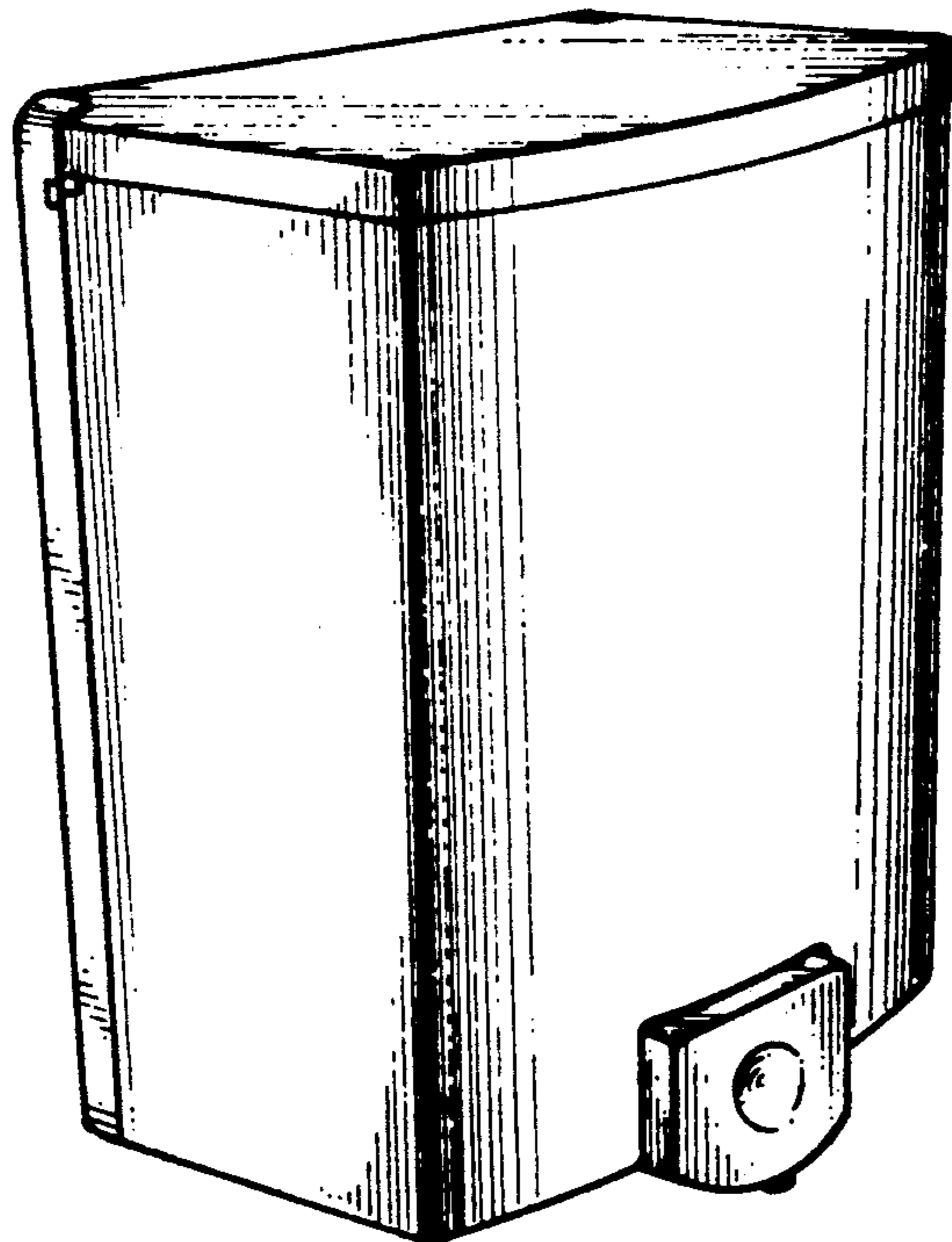

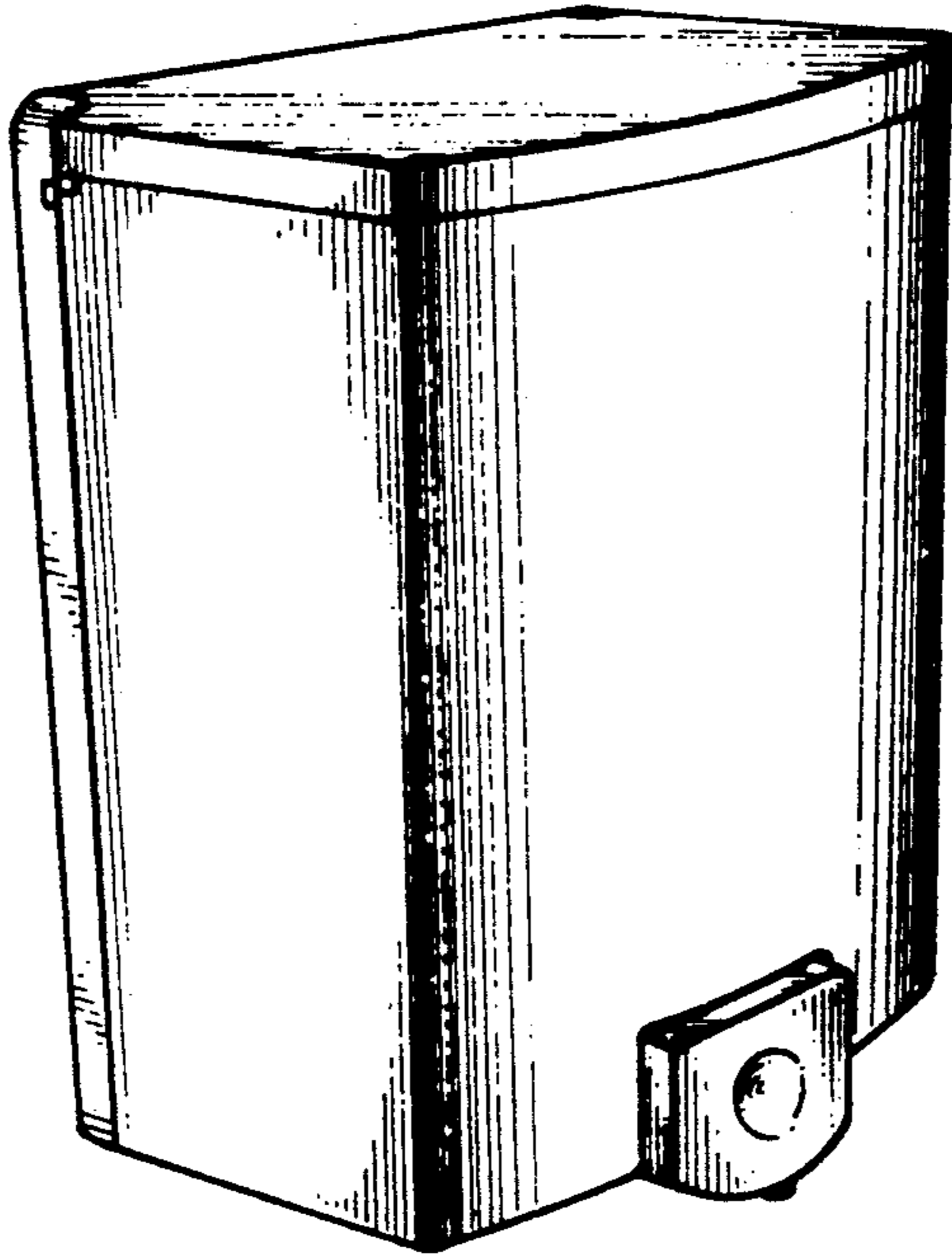

FIG. 1

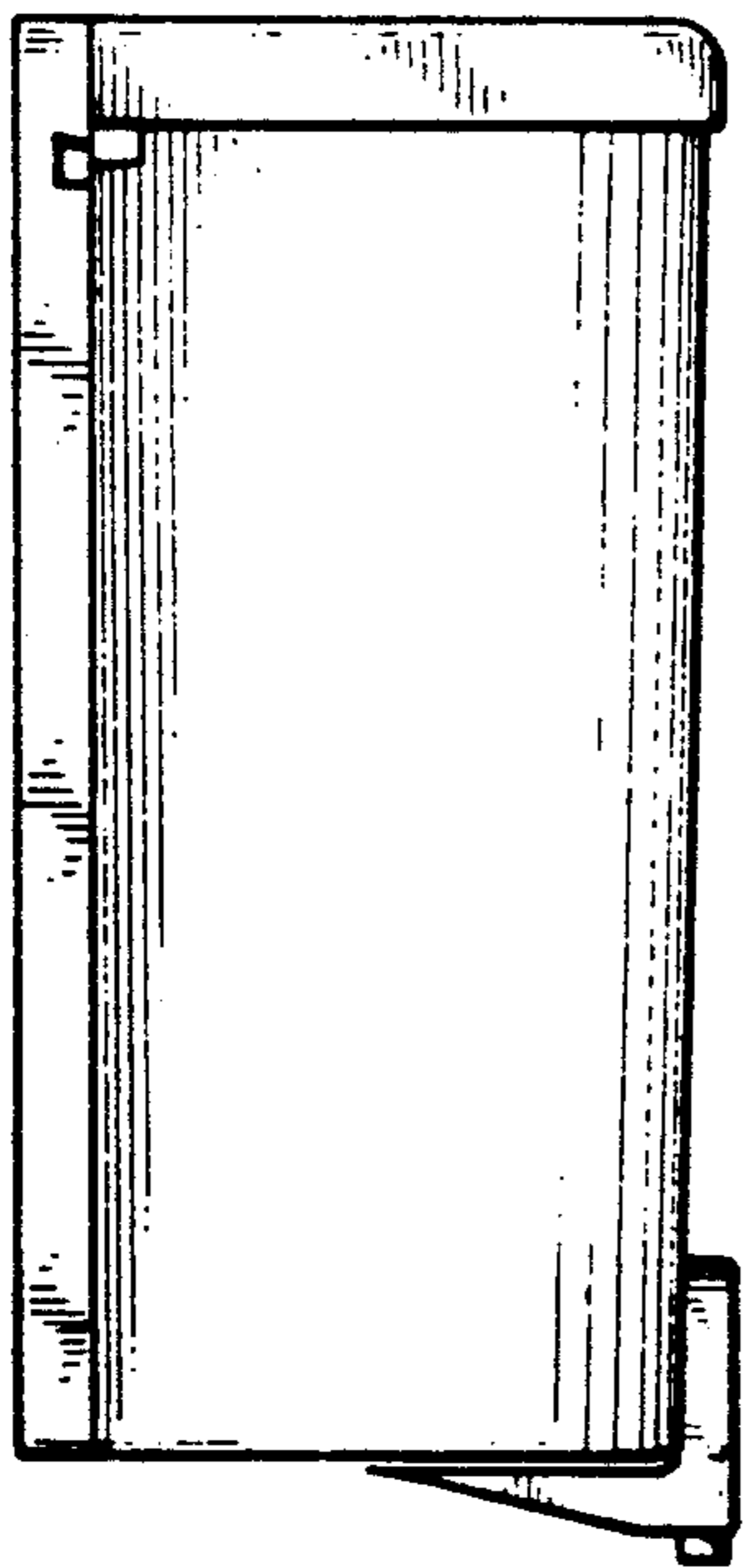

FIG. 3

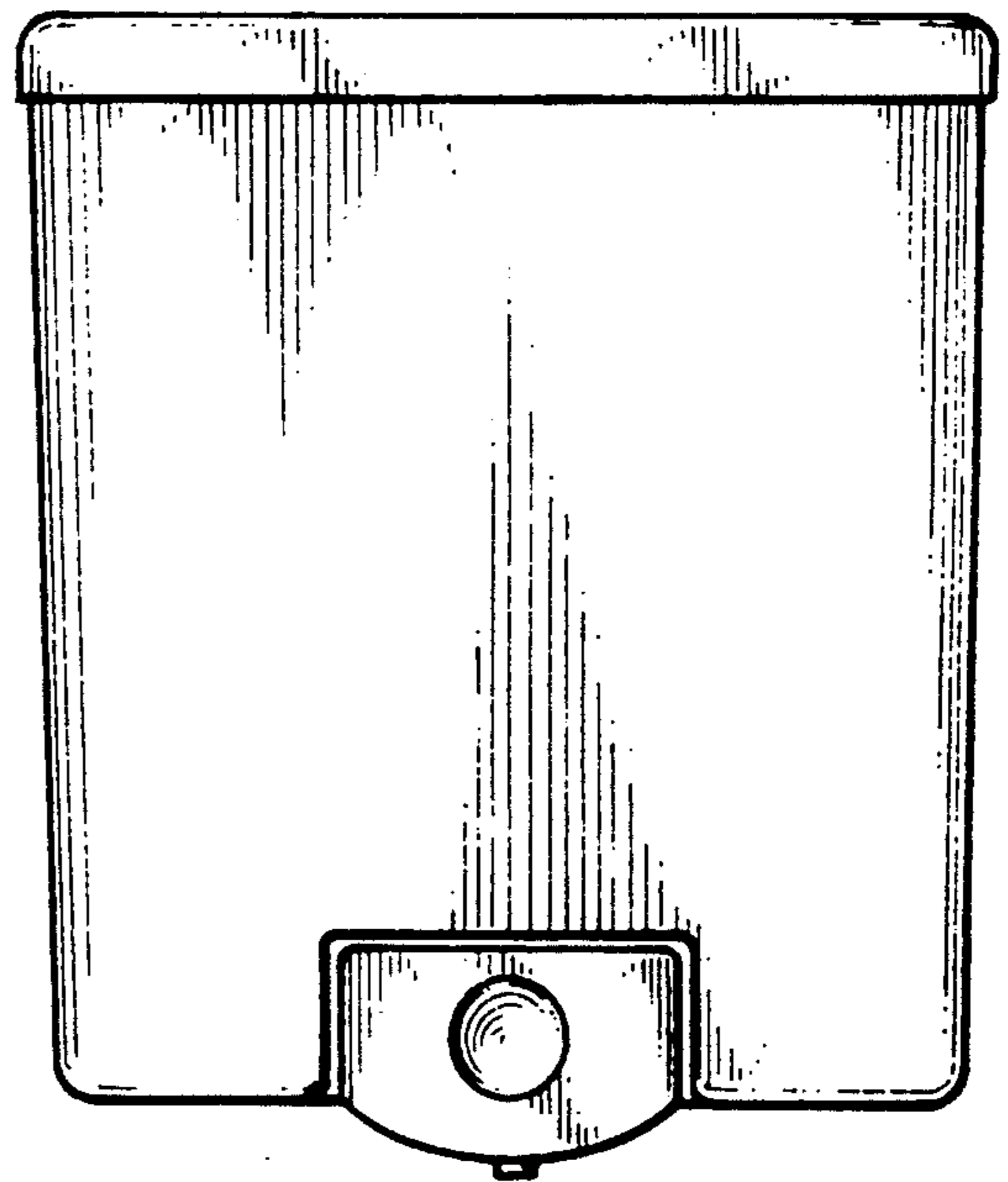

FIG. 2

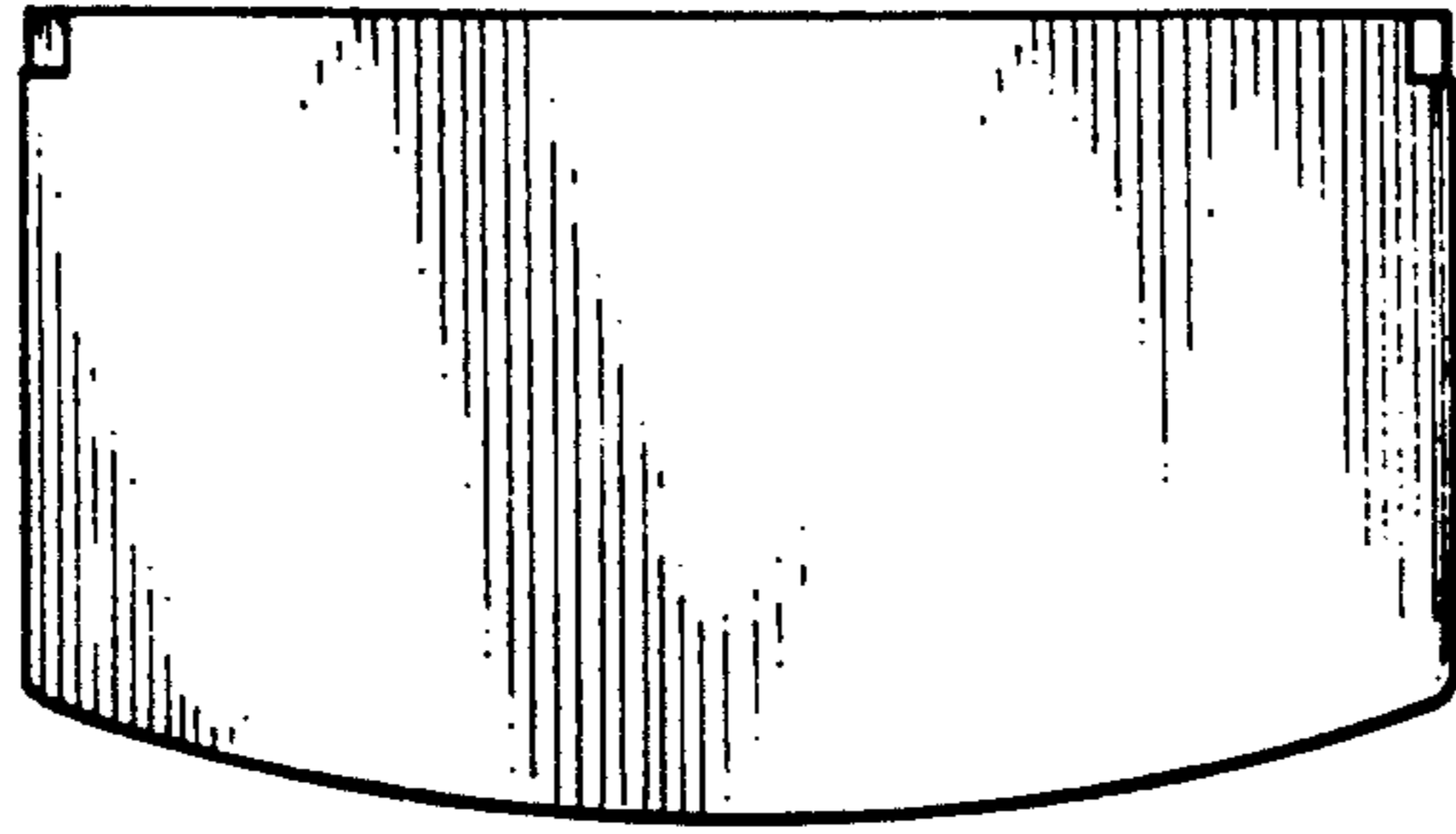

FIG. 5

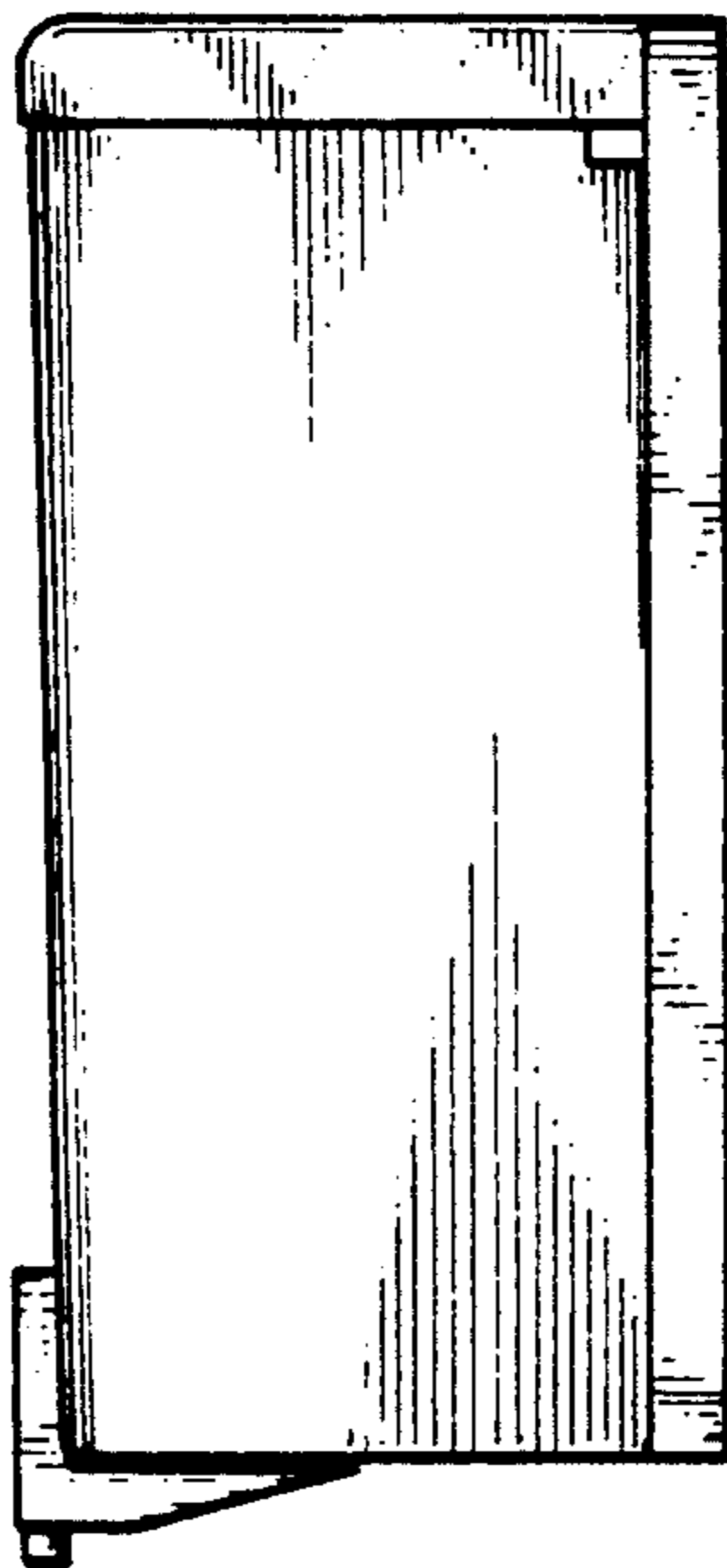

FIG. 4

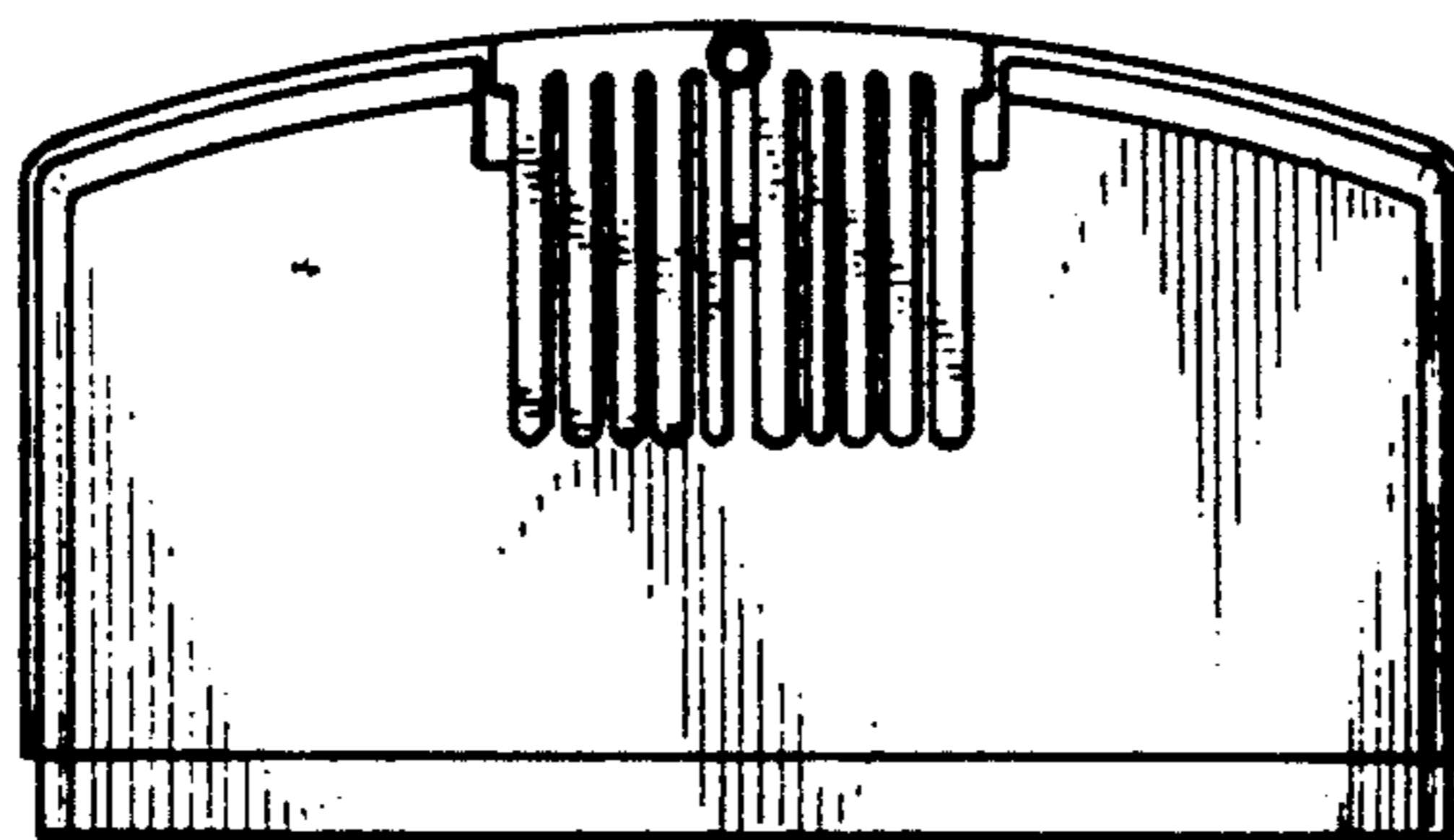

FIG. 6

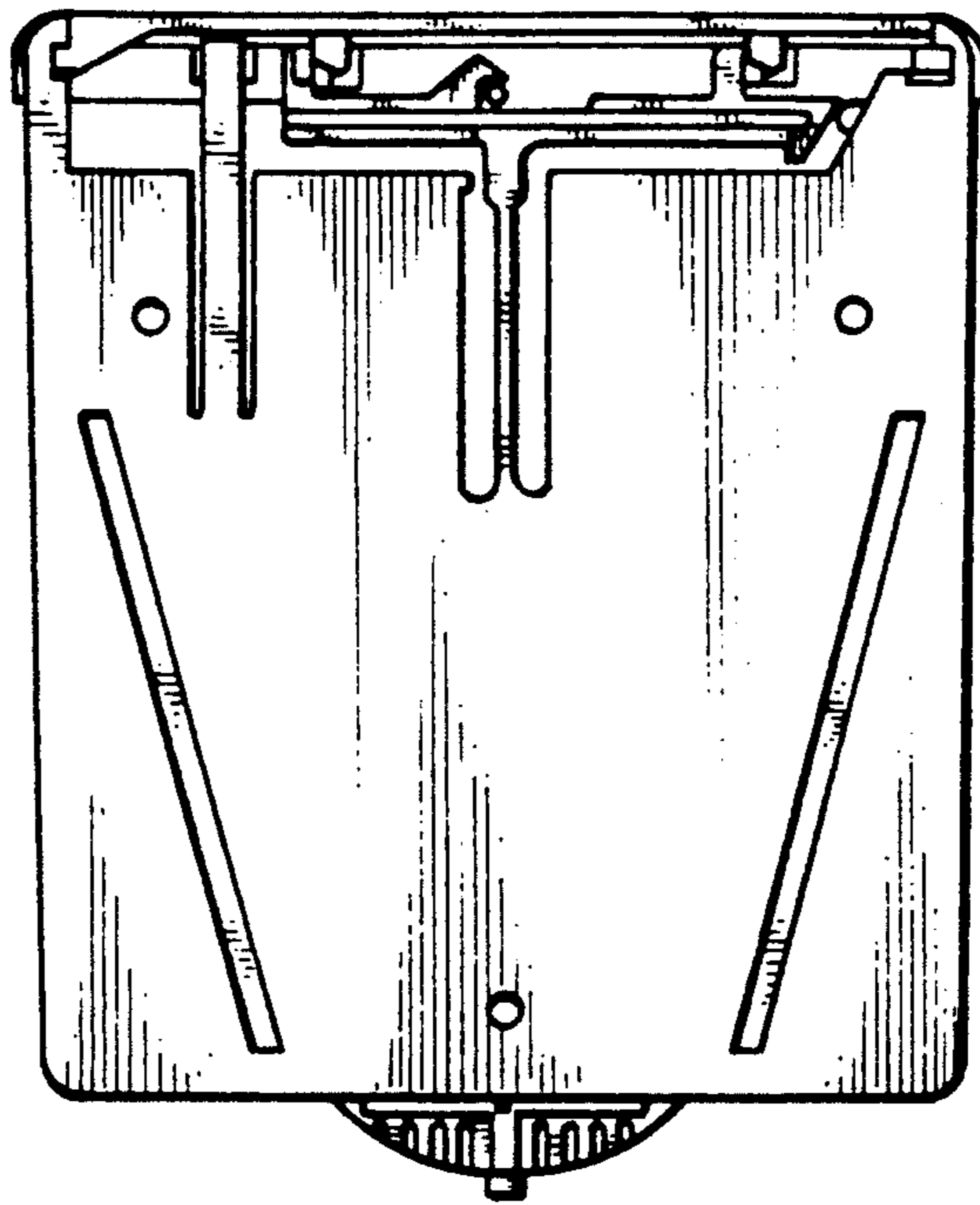

FIG. 7

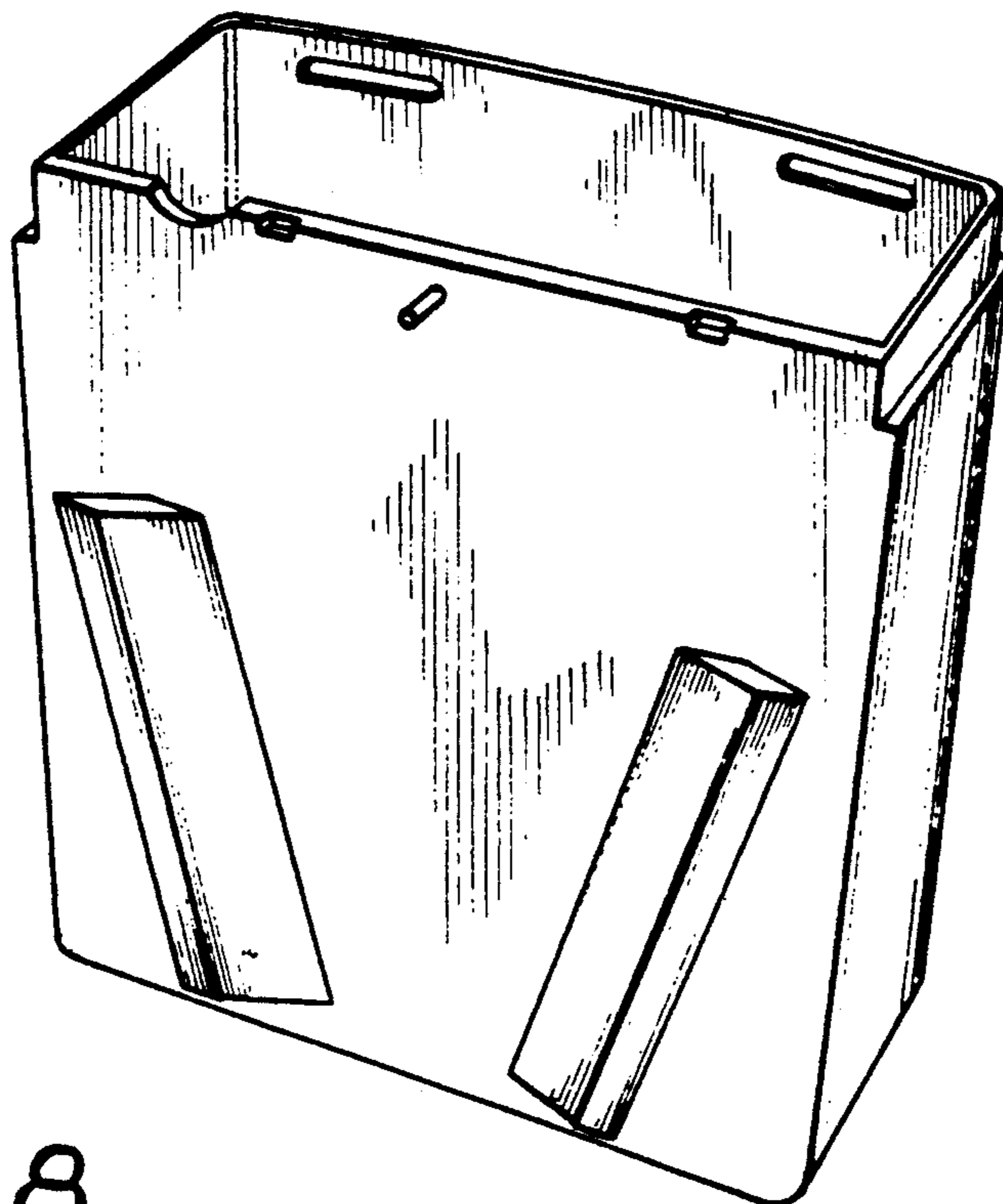

FIG. 8