



US00D332349S

United States Patent [19]

[11] Patent Number: **Des. 332,349**

Seifert et al.

[45] Date of Patent: **** Jan. 12, 1993**

[54] CONTAINER FOR DATA STORAGE DISKS
[75] Inventors: **Josef Seifert, Grosselfingen; Josef Kurz, Haigerloch-Owingen, both of Fed. Rep. of Germany**

2,249,265 7/1941 Bauder 211/11
3,904,003 9/1975 Margerum D3/76 X
4,020,930 5/1977 Weber D3/76 X
4,117,931 10/1978 Berkman D3/35 X
4,944,412 7/1990 Daigre 211/11
5,027,950 7/1991 Gutierrez et al. 206/309 X

[73] Assignee: **Kurz Kunststoffe GmbH, Owingen, Fed. Rep. of Germany**

Primary Examiner—Nelson C. Holtje
Assistant Examiner—Martha Thompson
Attorney, Agent, or Firm—Darby & Darby

[**] Term: **14 Years**

[21] Appl. No.: **596,044**

[57] CLAIM

[22] Filed: **Oct. 11, 1990**

The ornamental design for a container for data storage disks, as shown and described.

[30] Foreign Application Priority Data

DESCRIPTION

Apr. 12, 1990 [DE] Fed. Rep. of Germany 9002725
[52] U.S. Cl. **D3/35; D3/74; D19/75; D19/90**
[58] Field of Search D3/30.1, 35, 74, 76, D3/79; D19/75, 86, 90, 91, 99, 100; 206/425, 387, 309, 310, 444, 445; 211/11

FIG. 1 is a top, left front perspective view of a container for data storage disks showing our new design in an exploded condition;
FIG. 2 is a front elevational view thereof, the rear elevational view being identical thereto;
FIG. 3 is a left side elevational view thereof, the right side elevational view being identical thereto;
FIG. 4 is a top plan view thereof;
FIG. 5 is a bottom plan view thereof;
FIG. 6 is a perspective view thereof with the cover removed and the pocket portion in expanded state; and,
FIG. 7 is a left side elevational view with the cover removed and the pocket portion in expanded state, the right side elevational view being identical thereto.

[56] References Cited

U.S. PATENT DOCUMENTS

D. 260,578 9/1981 Cox D3/52
D. 283,948 5/1986 Clouser et al. D3/35
D. 287,425 12/1986 Kirchner D3/35
D. 307,075 4/1990 Pollack D3/35
1,966,555 7/1934 Le Febure 211/11

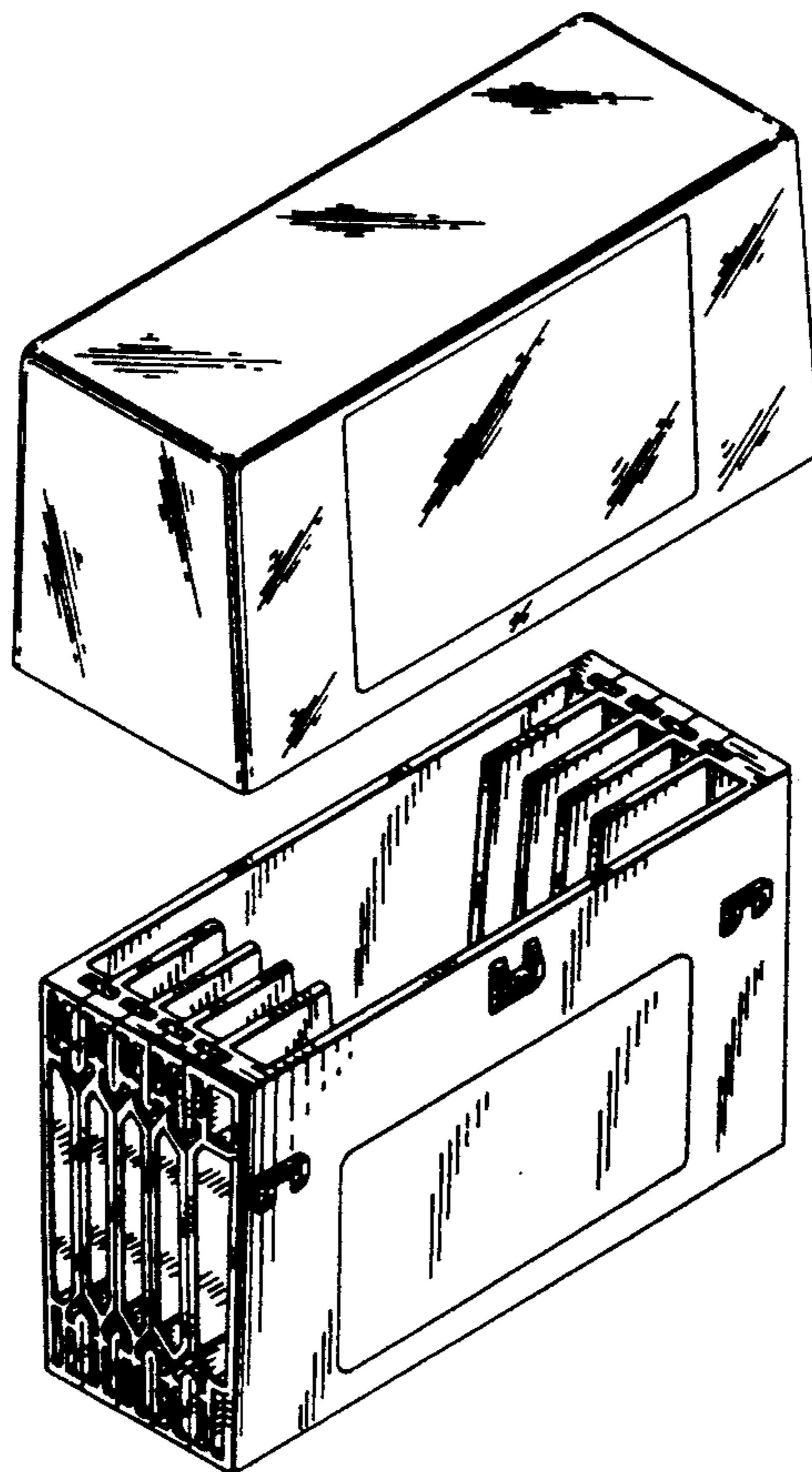

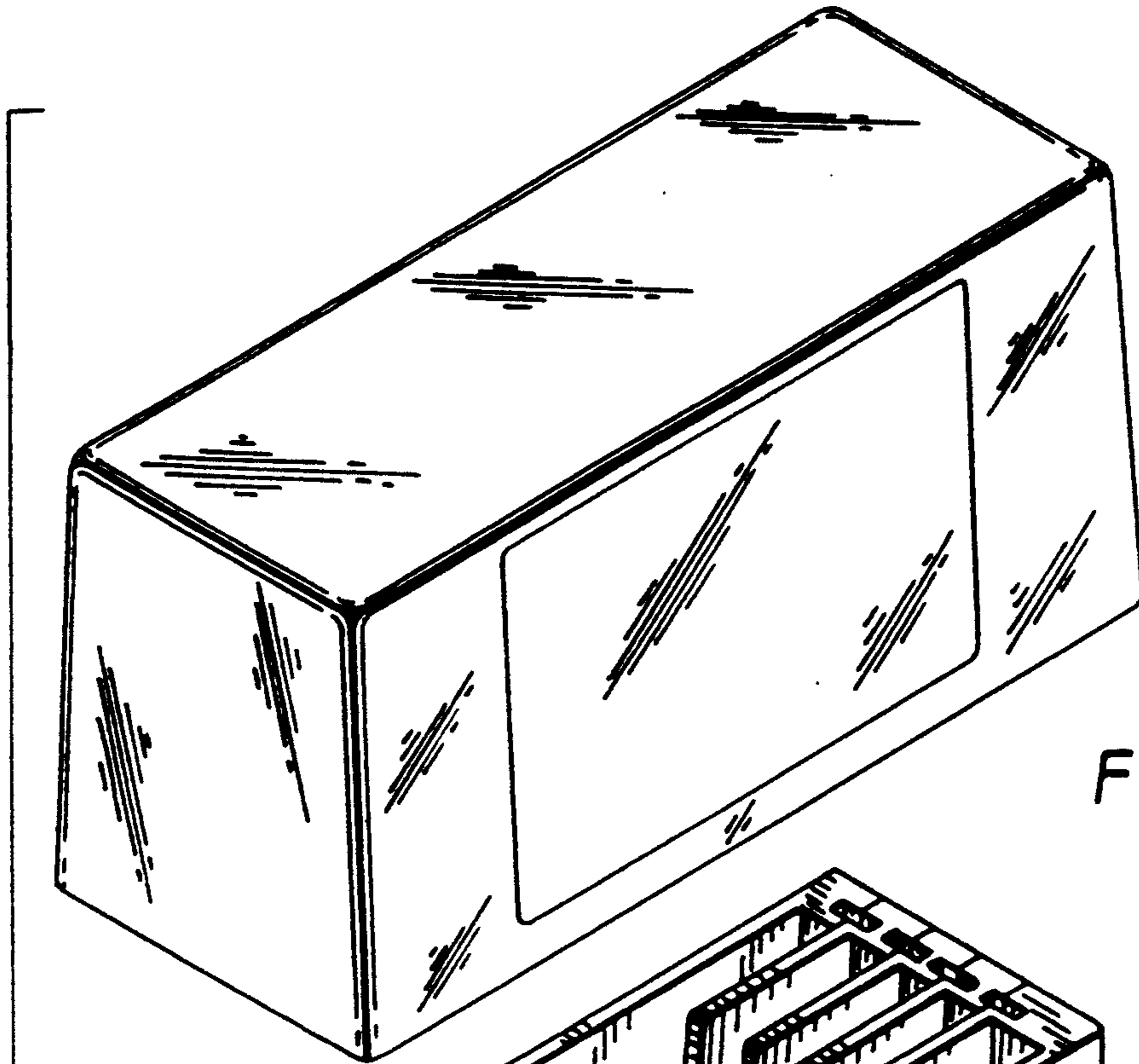
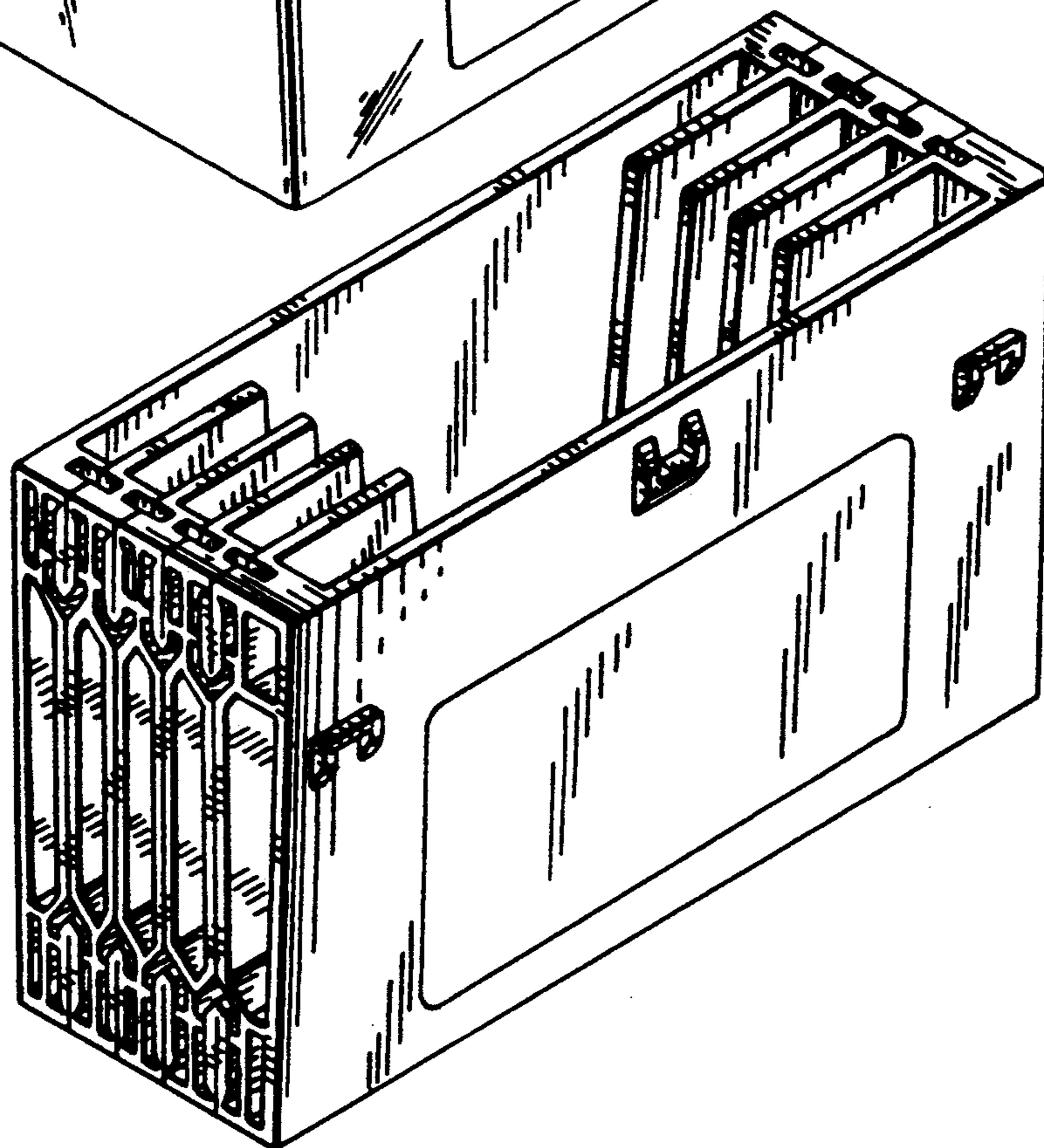

FIG. 1



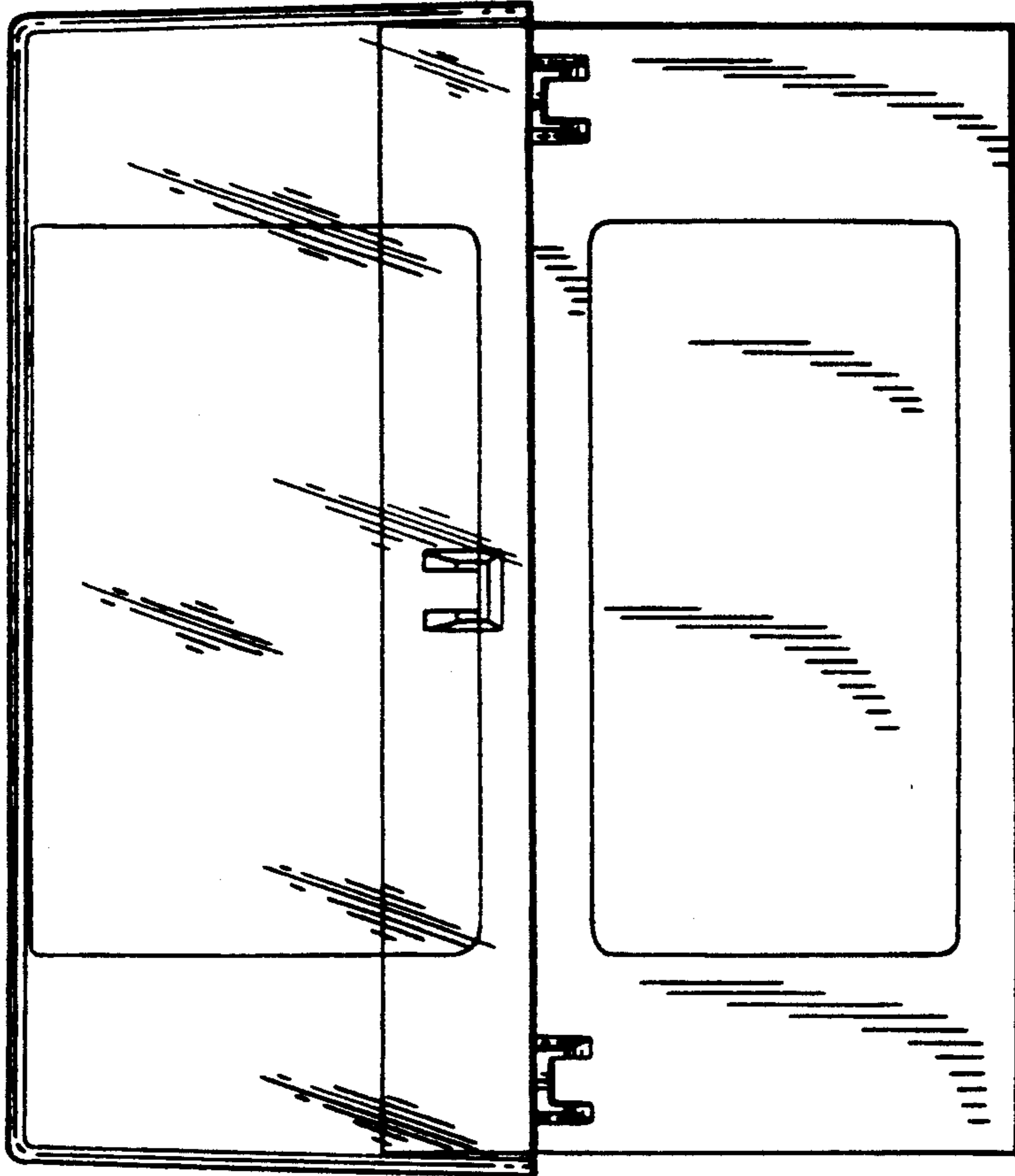

FIG. 2

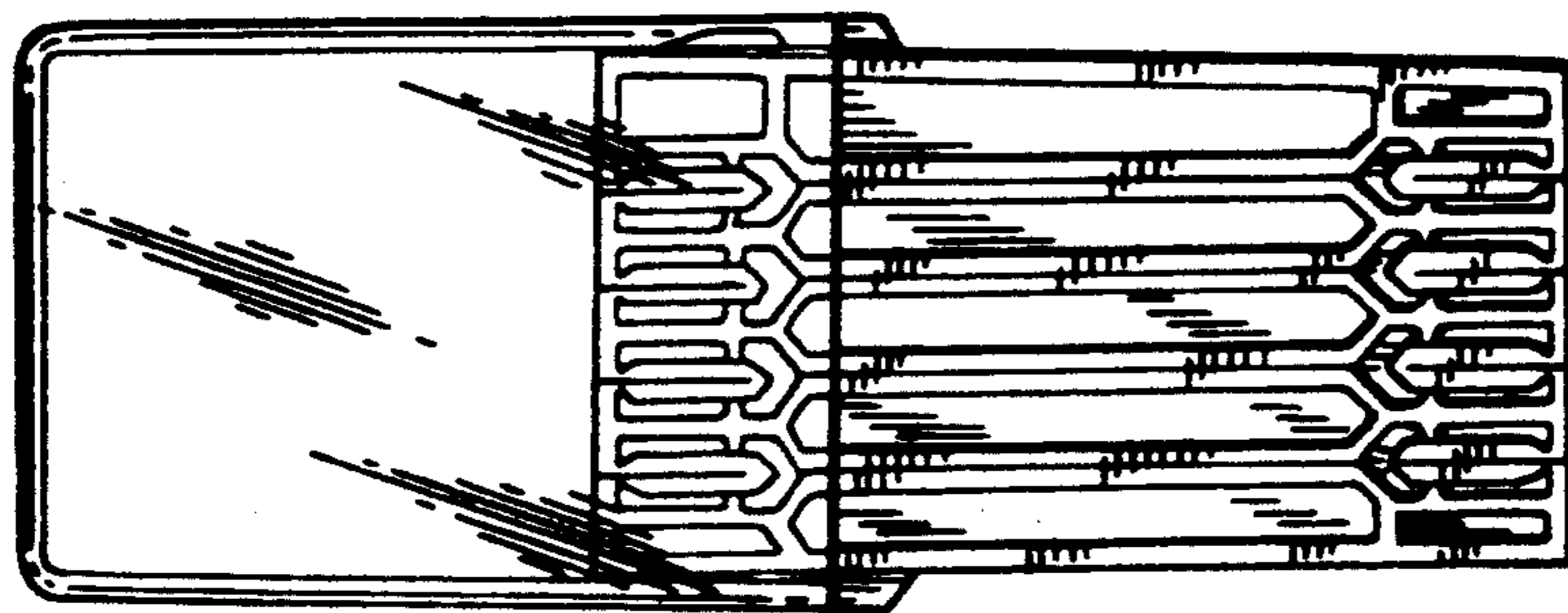

FIG. 3

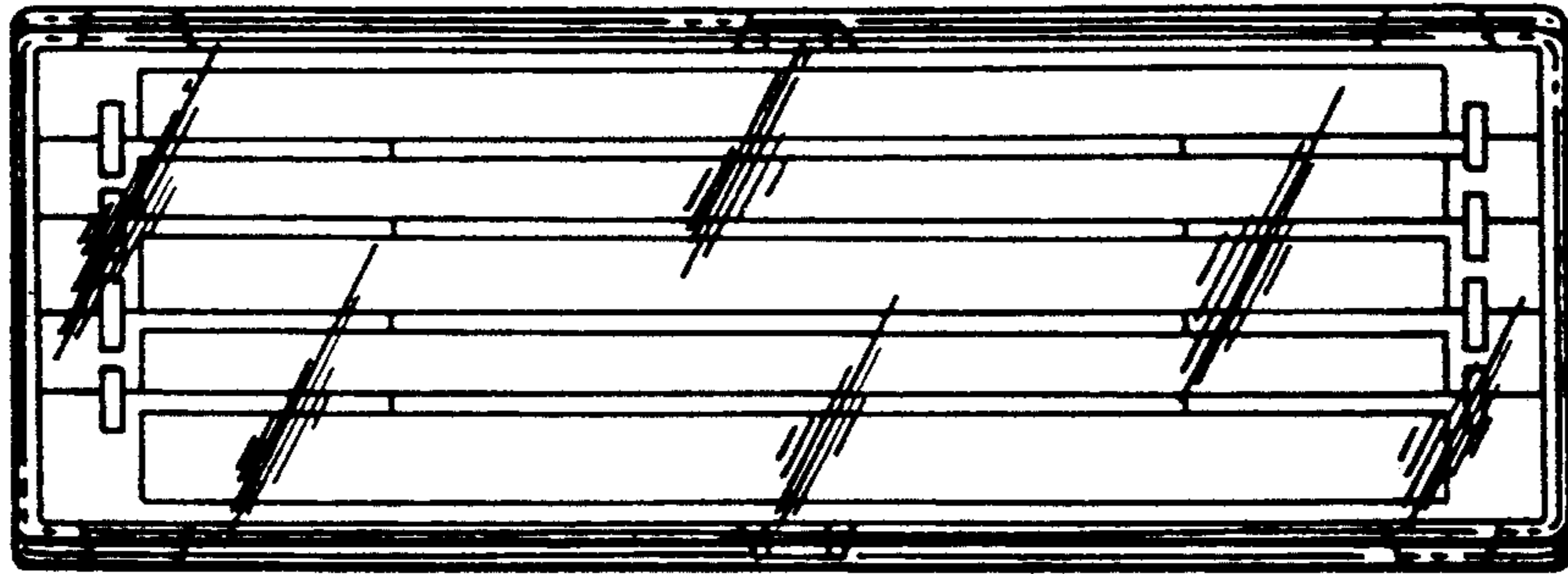

FIG. 4

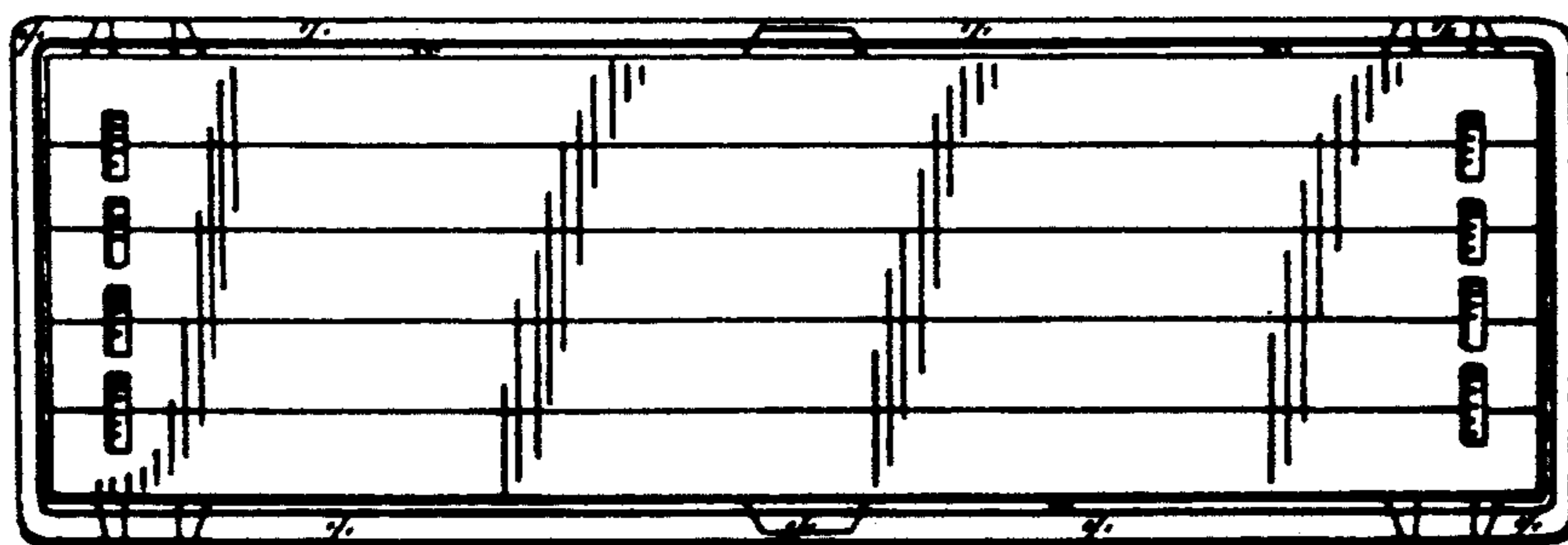

FIG. 5

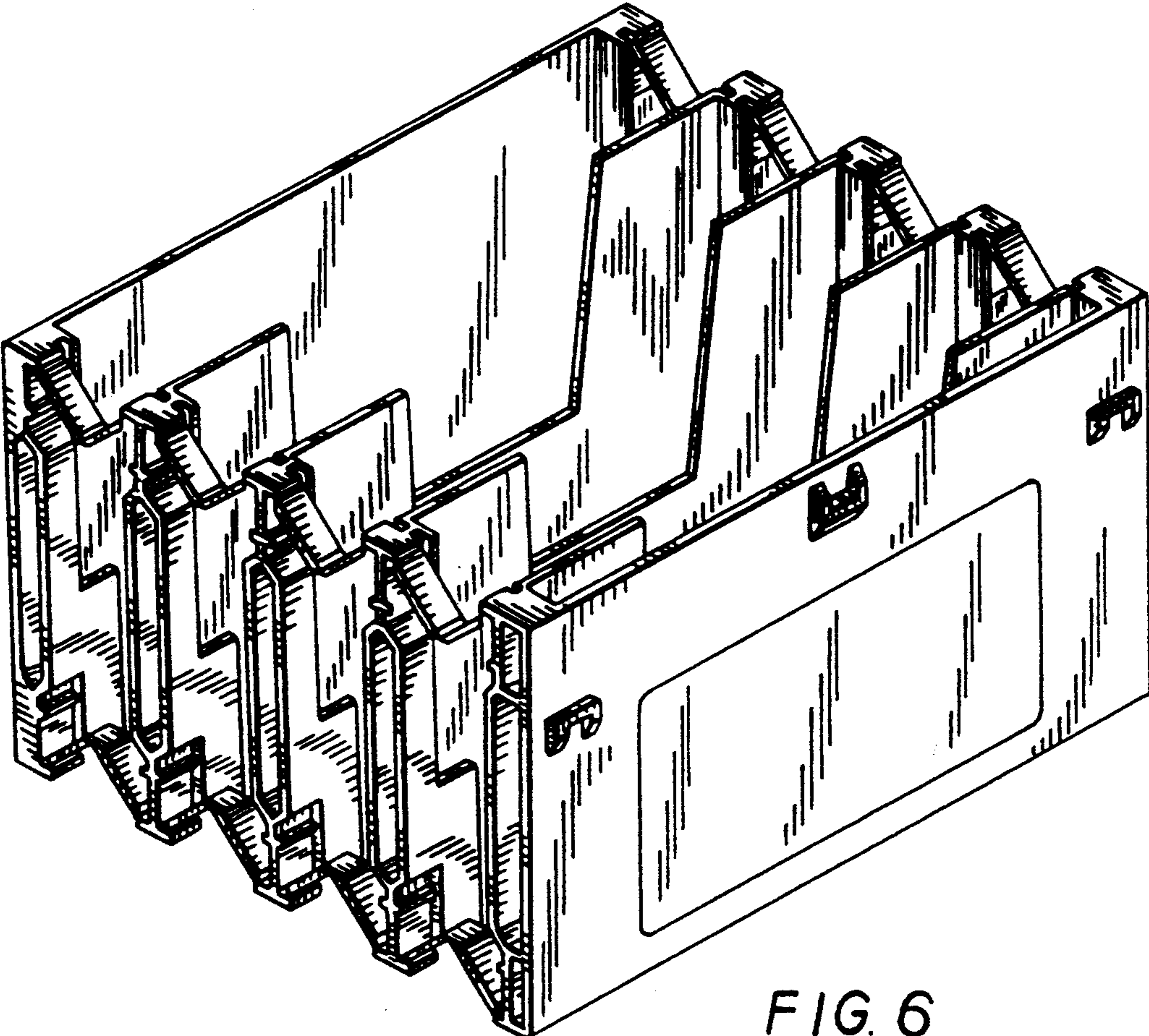

FIG. 6

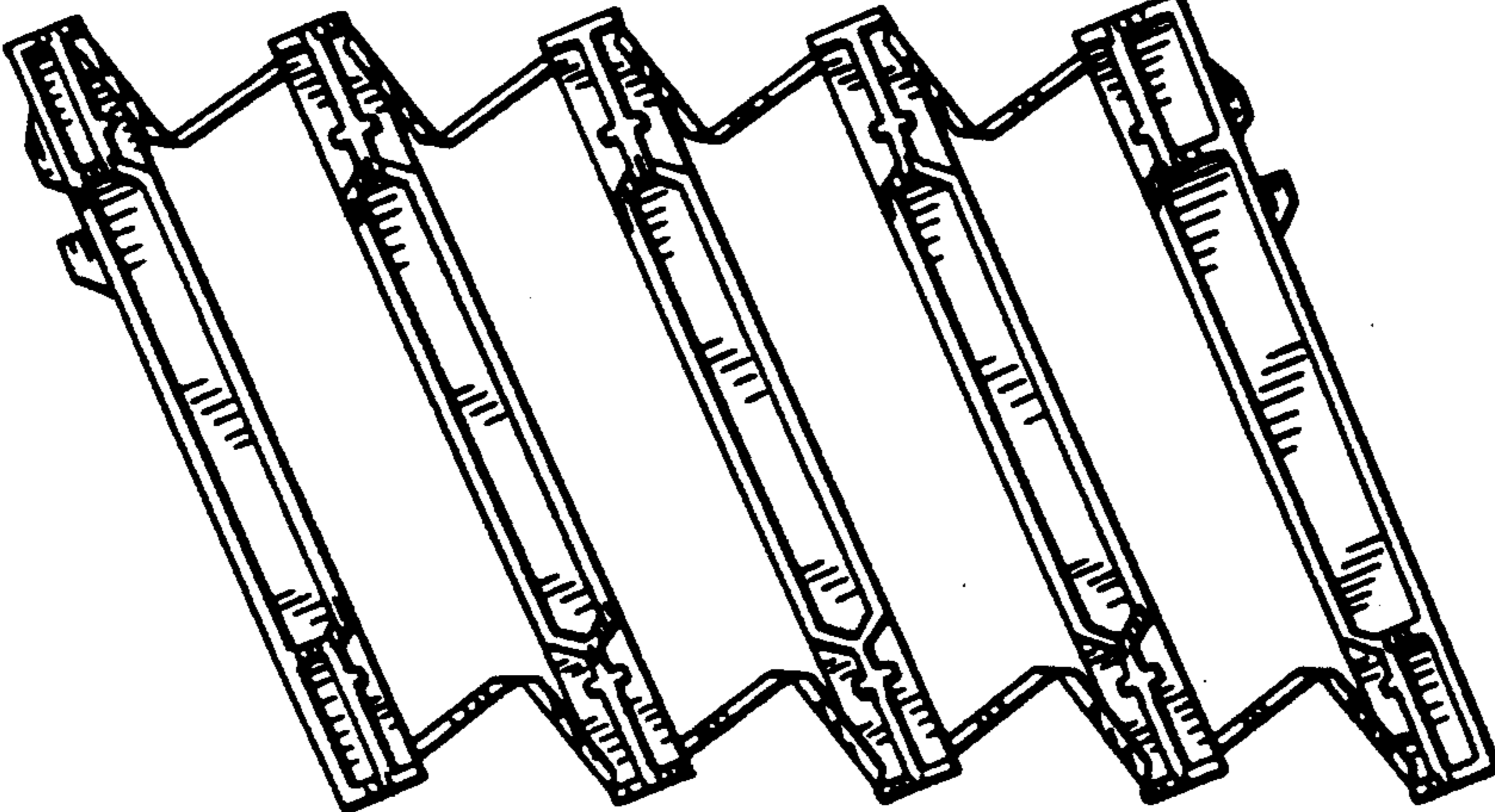

FIG. 7