



US00D332252S

United States Patent [19]

[11] Patent Number: **Des. 332,252**

Kovacik et al.

[45] Date of Patent: **** Jan. 5, 1993**

[54] **FEMALE ELECTRICAL CONNECTOR WITH OVERLOAD PROTECTION**

4,684,914 8/1987 Wu 439/622 X
4,758,184 7/1988 Call 439/622
4,904,976 2/1990 Liaq 439/622 X

[75] Inventors: **James D. Kovacik**, Brecksville;
Thomas J. Blanch, Hudson; **Paul S. Blanch**, Valley View, all of Ohio

OTHER PUBLICATIONS

Triple receptacle cordset connectors on the front cover of Corol Cordsets 1985 Catalog.

[73] Assignee: **Alert Safety Lite Products Co., Inc.**, Bedford Heights, Ohio

Primary Examiner—Wallace R. Burke
Assistant Examiner—Joel Sincavage
Attorney, Agent, or Firm—William J. Clemens

[**] Term: **14 Years**

[21] Appl. No.: **655,895**

[57] CLAIM

[22] Filed: **Feb. 14, 1991**

[52] U.S. Cl. **D13/142; D13/143**

The ornamental design for a female electrical connector with overload protection, as shown and described.

[58] Field of Search **D13/137, 139, 140, 141, D13/142, 143, 160; 439/620, 621, 622; 337/197**

DESCRIPTION

[56] References Cited

U.S. PATENT DOCUMENTS

| | | | | |
|------------|---------|----------------|-------|-----------|
| D. 276,225 | 11/1984 | Powell | | D13/139 |
| D. 277,370 | 1/1985 | Gehr et al. | | D13/139 |
| D. 295,622 | 5/1988 | Good et al. | | D13/139 |
| 3,539,961 | 11/1970 | Worthington | | 337/197 |
| 4,138,185 | 2/1979 | Jaconette, Jr. | | D13/143 X |
| 4,307,925 | 12/1981 | Drew | | 439/622 |
| 4,418,978 | 12/1983 | Shamir | | 439/622 X |
| 4,420,214 | 12/1983 | Wu | | 439/622 |
| 4,480,891 | 11/1984 | Wu | | 362/80 |
| 4,573,031 | 2/1986 | Krasser | | 337/68 |
| 4,575,704 | 3/1986 | Pezold | | 337/197 |
| 4,592,613 | 6/1986 | Tong | | 439/622 |
| 4,661,892 | 4/1987 | Reed, Jr. | | 362/226 |
| 4,667,175 | 5/1987 | Sell | | 337/437 X |

FIG. 1 is a left side elevational view of a female electrical connector with overload protection showing my new design;

FIG. 2 is a rear elevational view thereof;

FIG. 3 is a front elevational view thereof;

FIG. 4 is a right side elevational view thereof;

FIG. 5 is a top plan view thereof;

FIG. 6 is a bottom plan view thereof;

FIG. 7 is a left side elevational view of a female electrical connector with overload protection showing a second embodiment of the design;

FIG. 8 is a rear elevational view thereof;

FIG. 9 is front elevational view thereof;

FIG. 10 is the right side elevational view thereof;

FIG. 11 is a top plan view thereof; and,

FIG. 12 is a bottom plan view thereof.

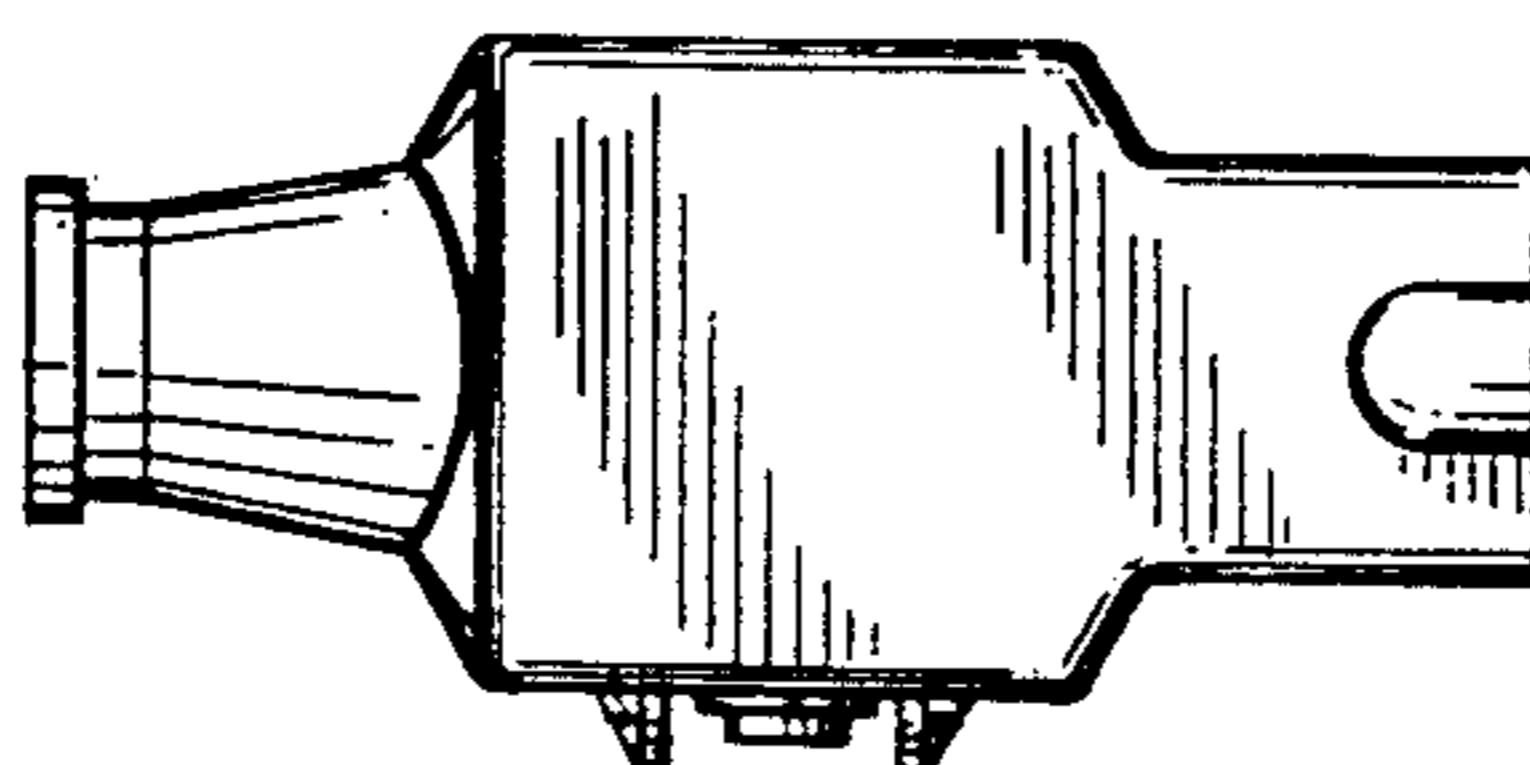
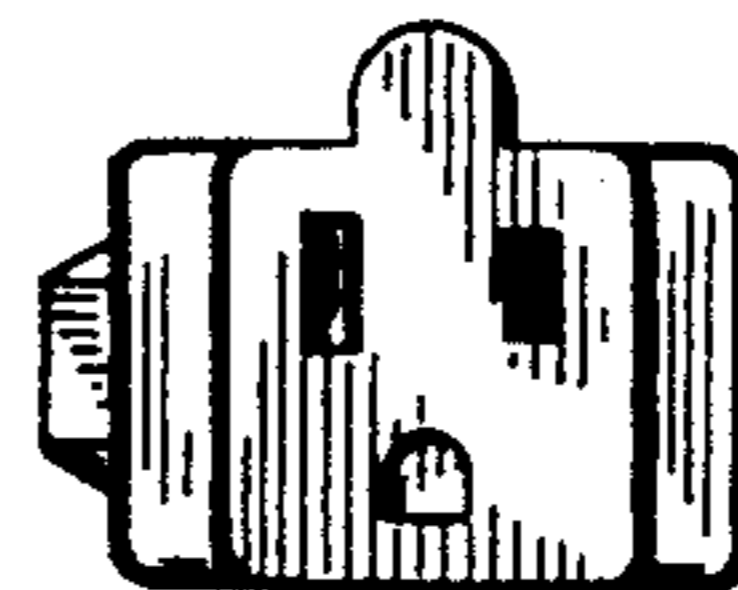
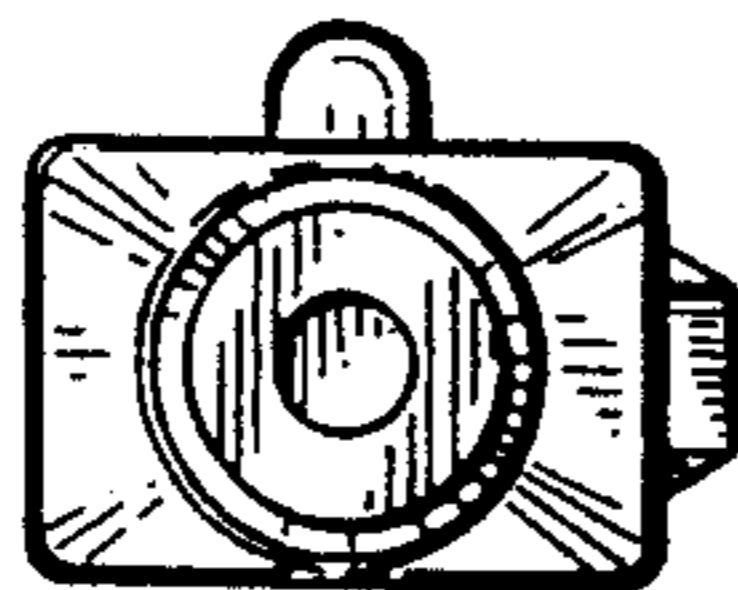
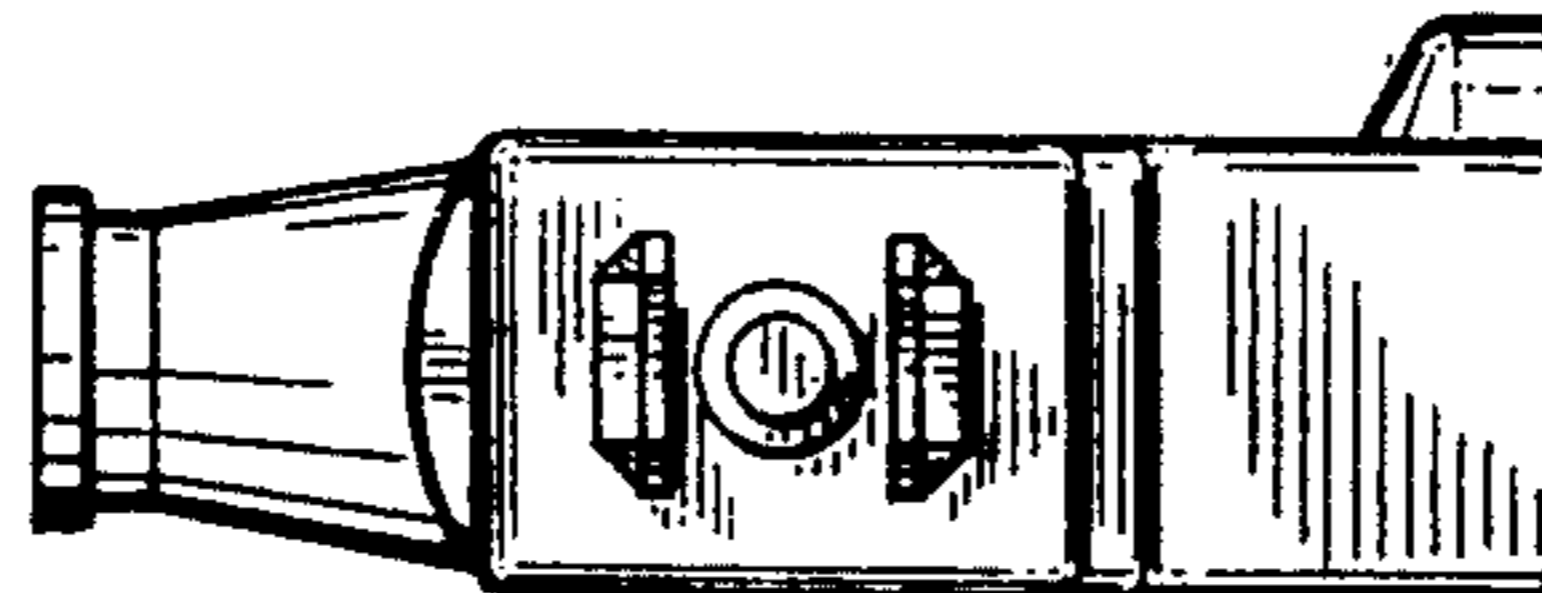

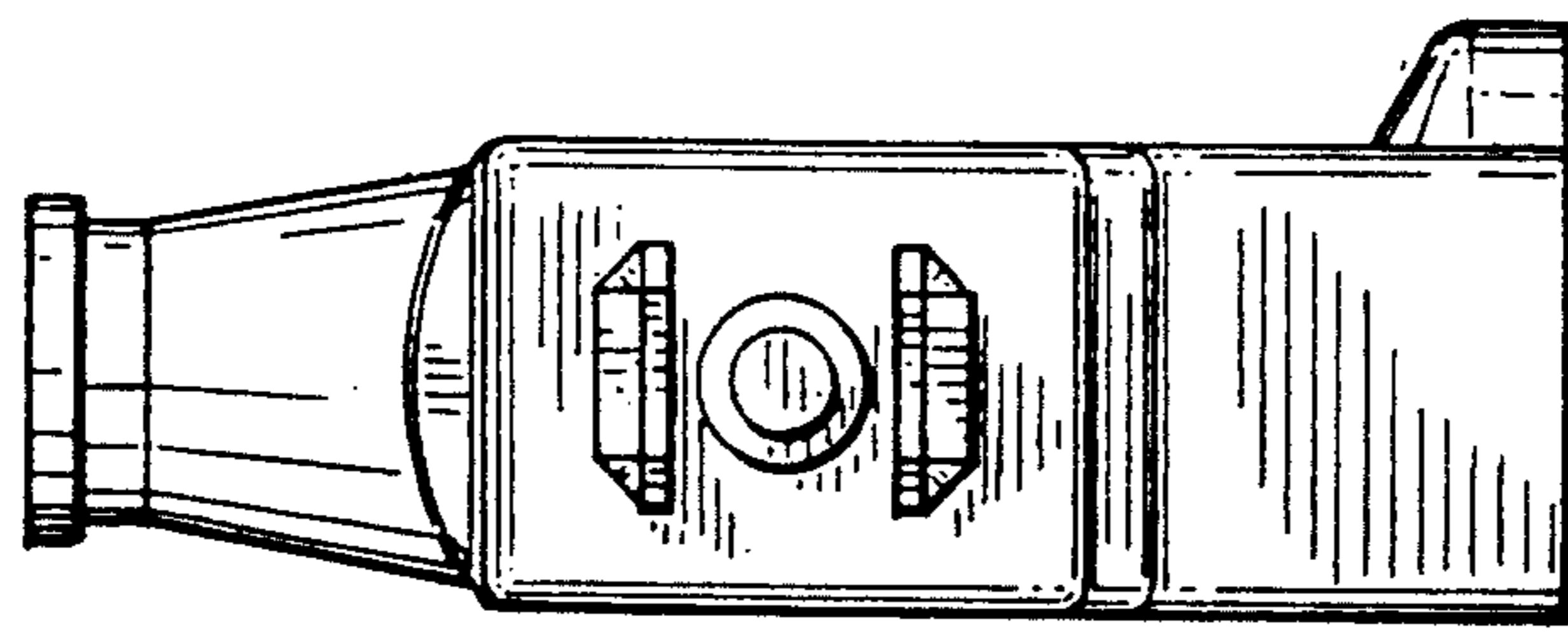

FIG. 1

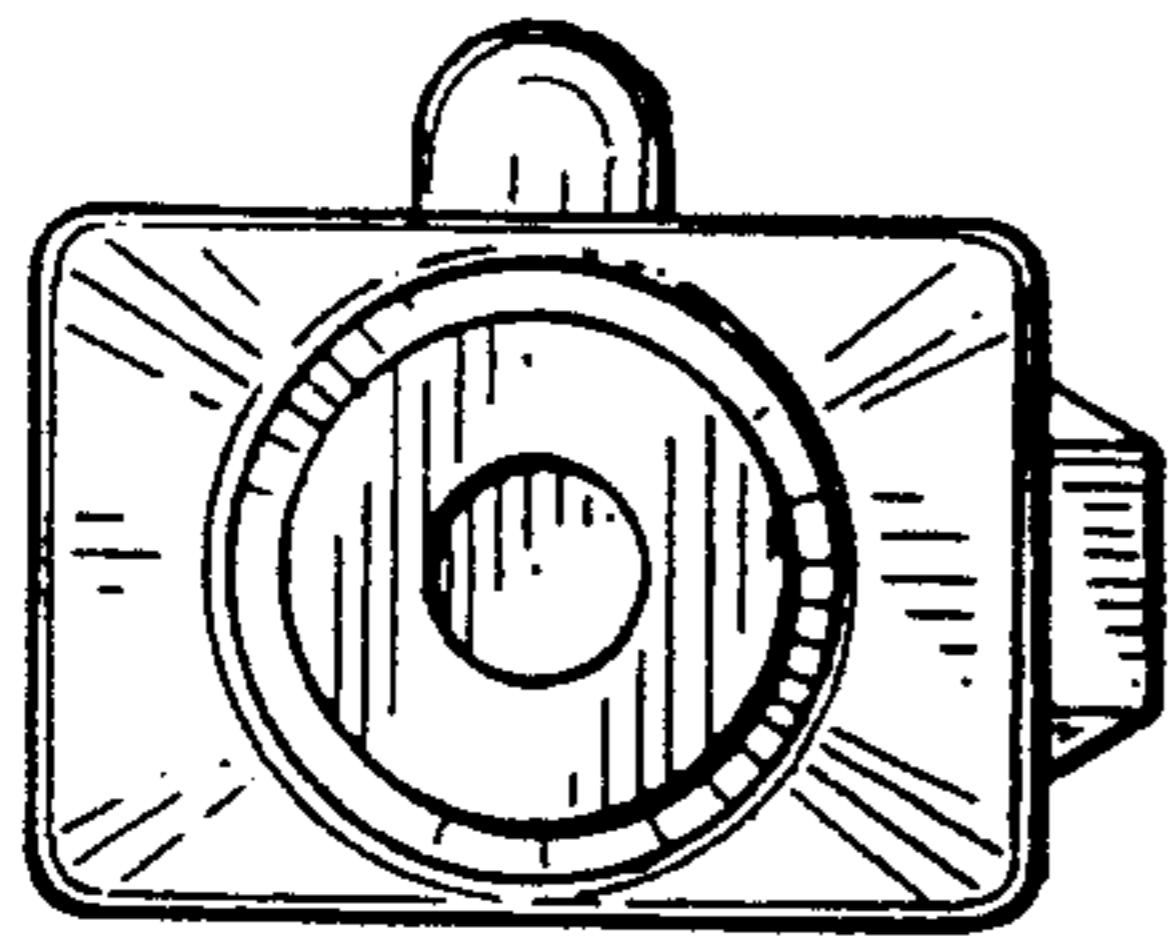

FIG. 2

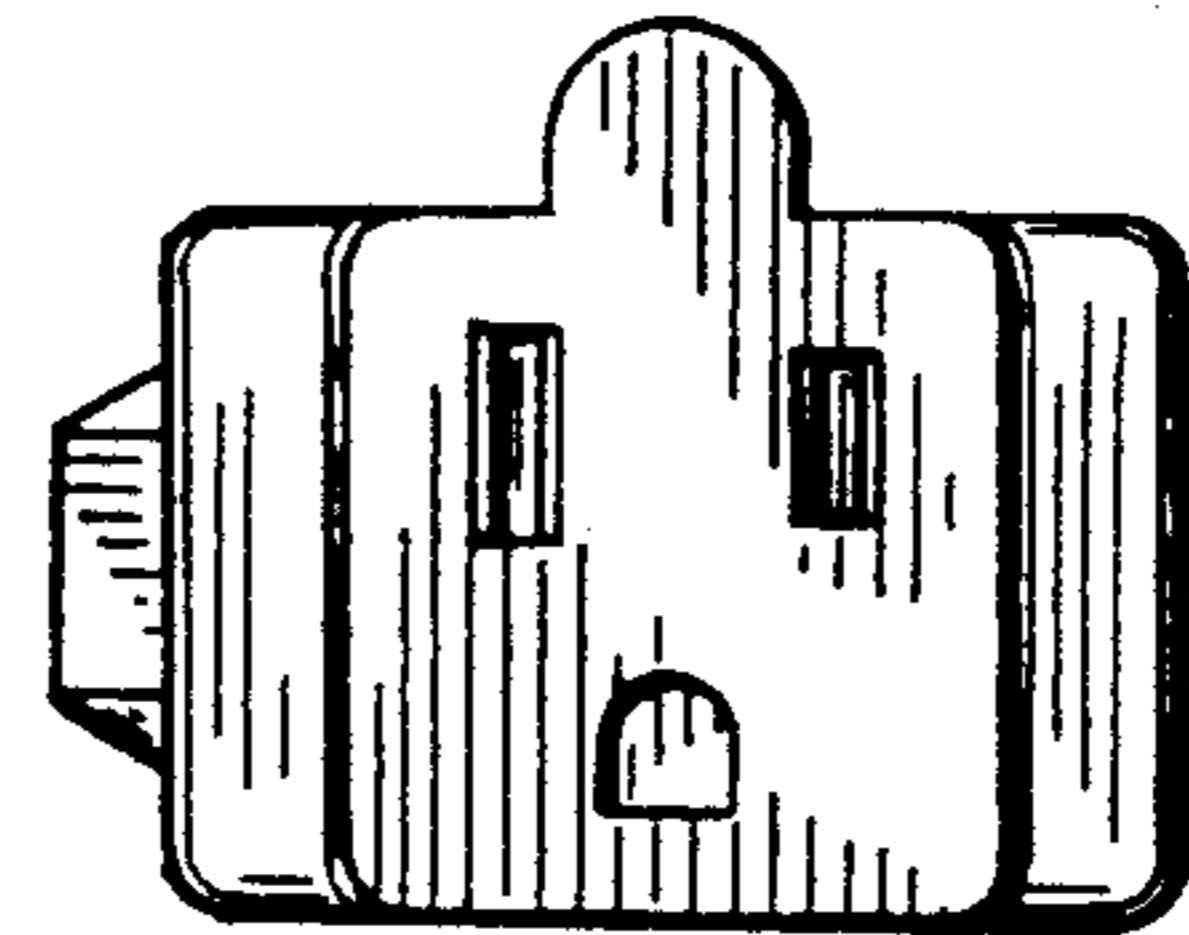

FIG. 3

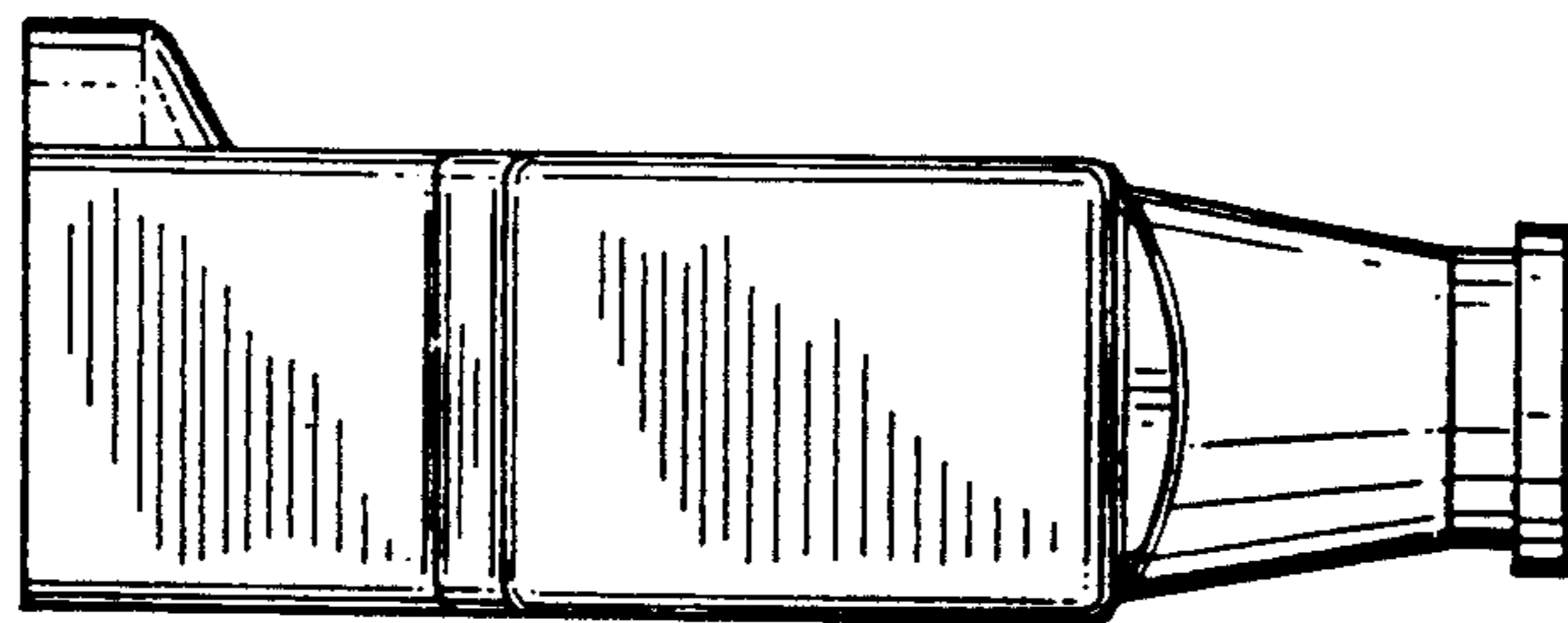

FIG. 4

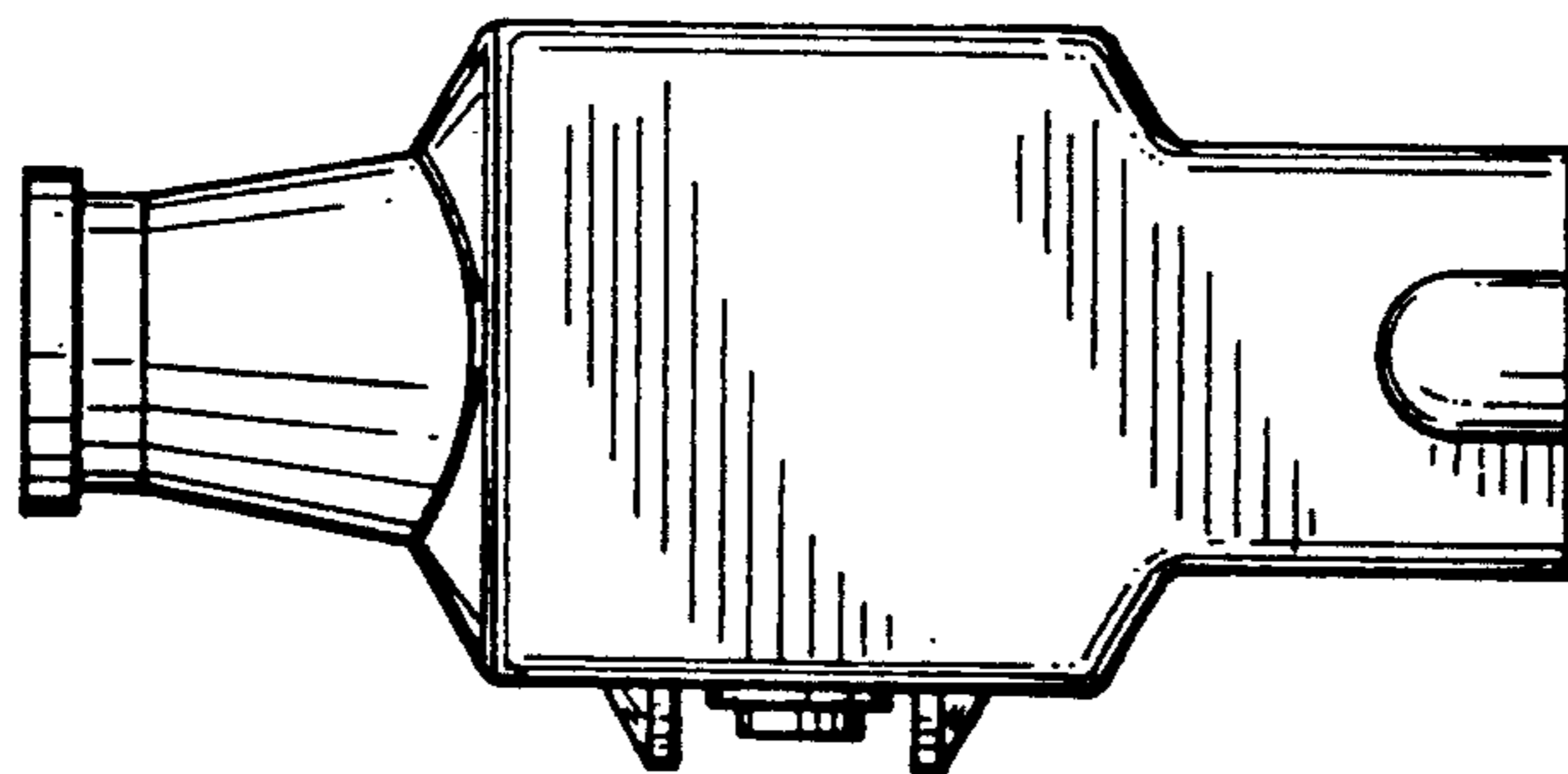

FIG. 5

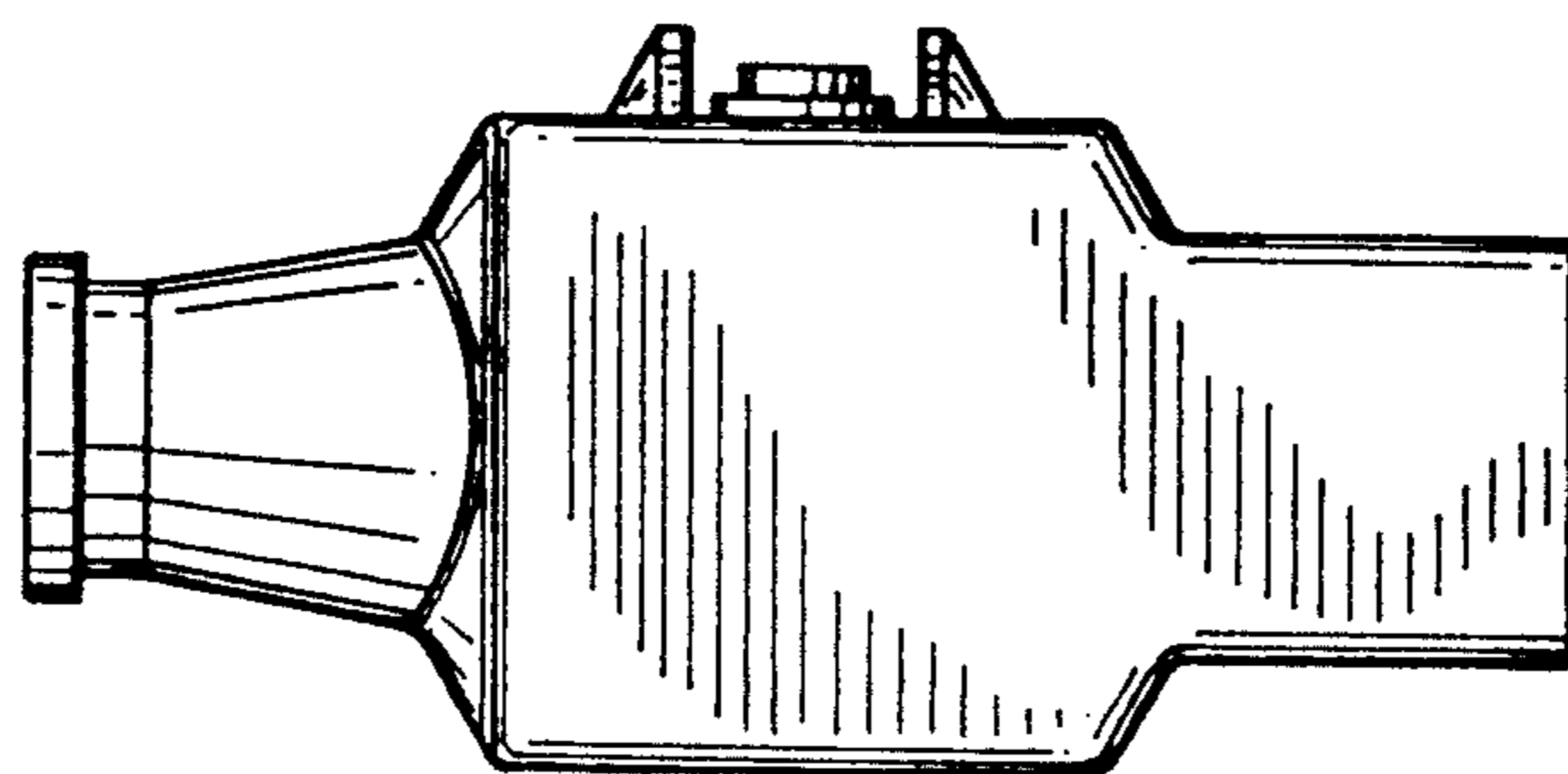

FIG. 6

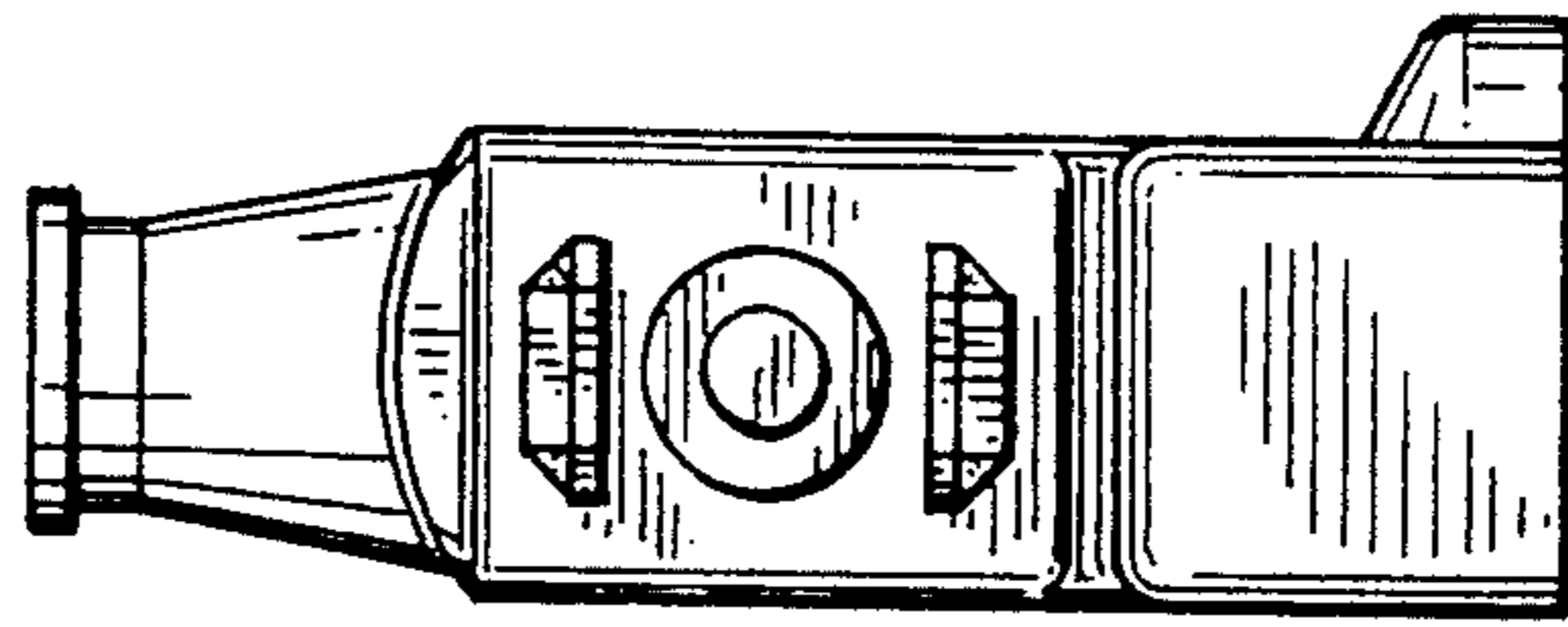

FIG. 7

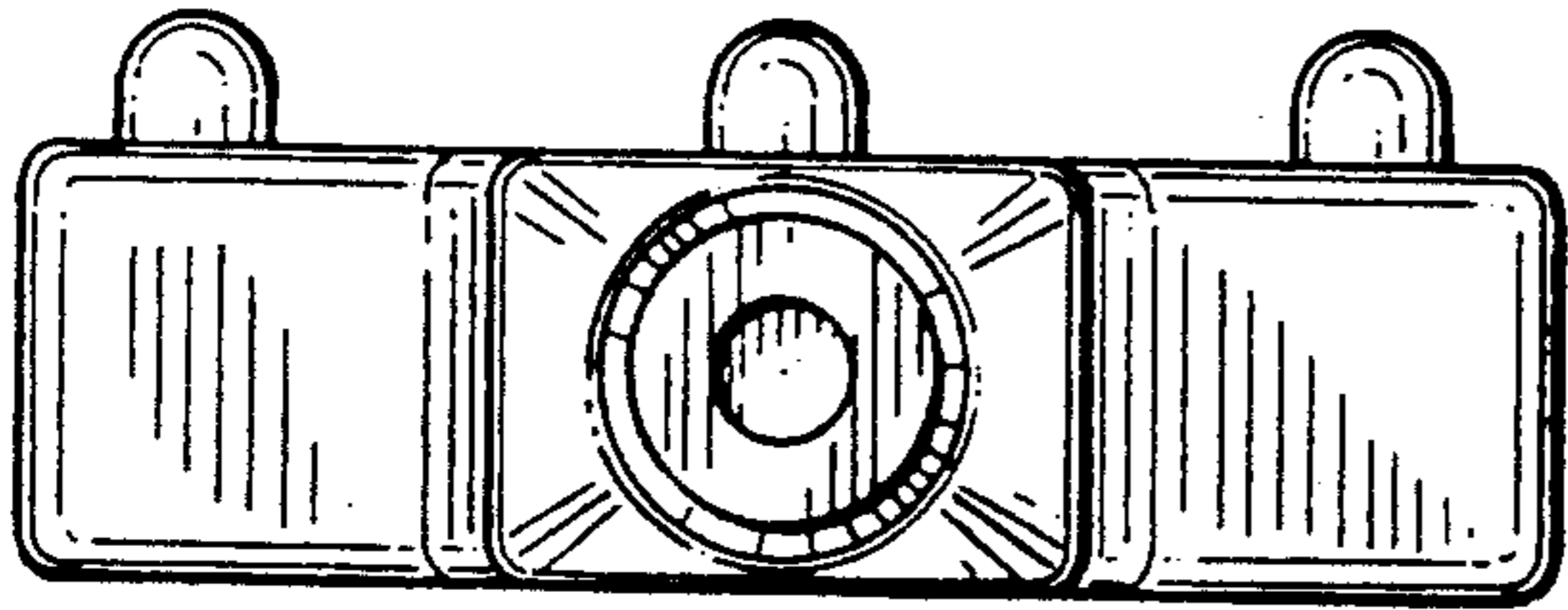

FIG. 8

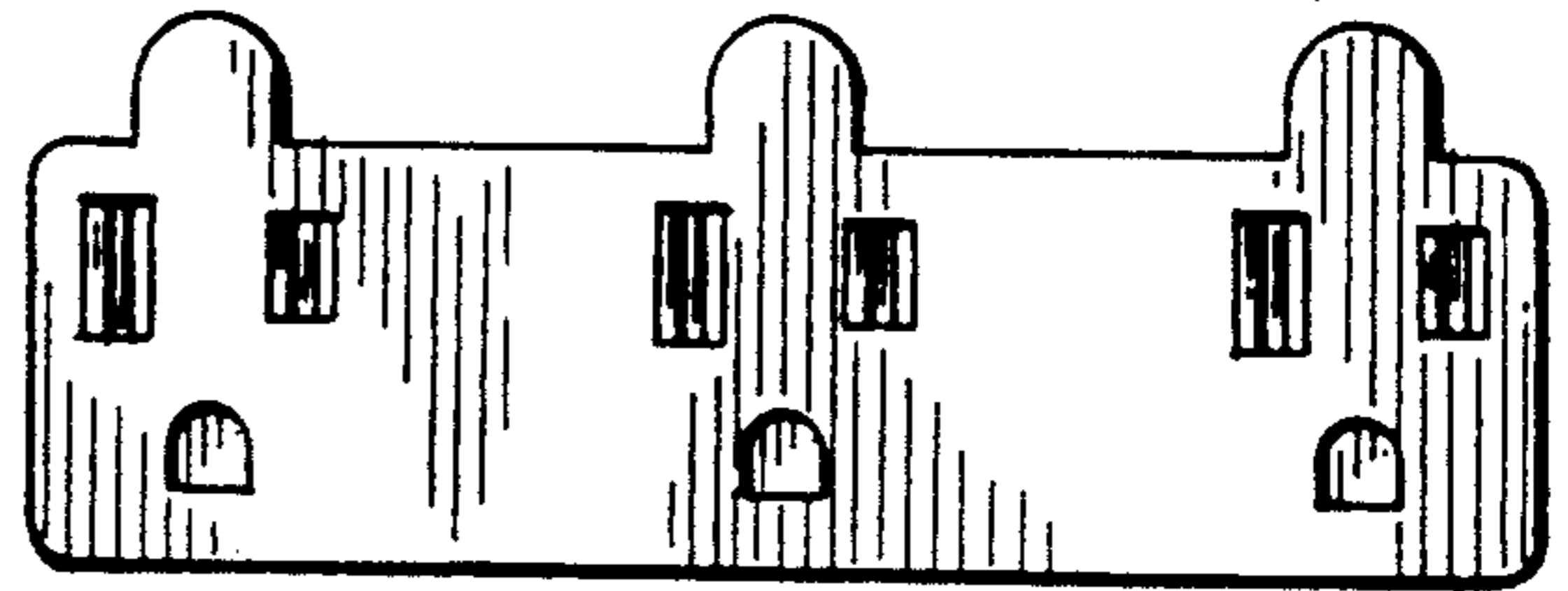

FIG. 9

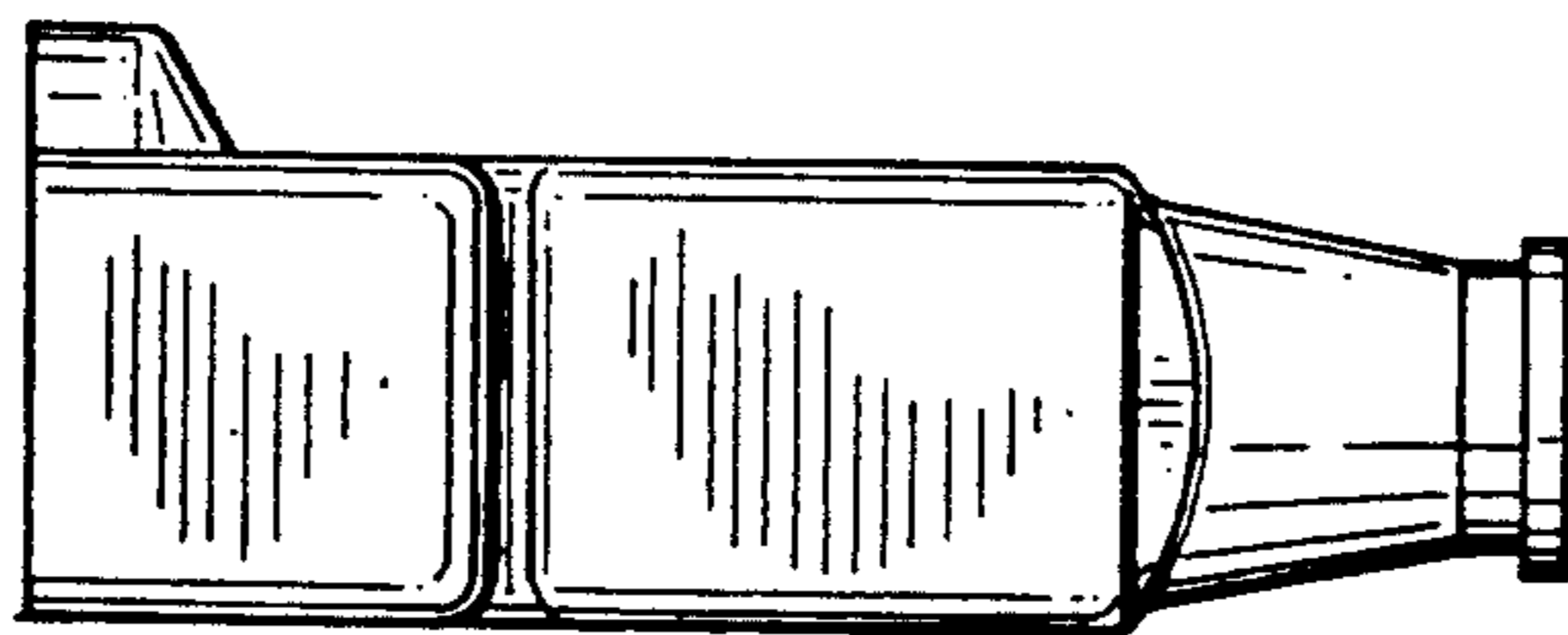

FIG. 10

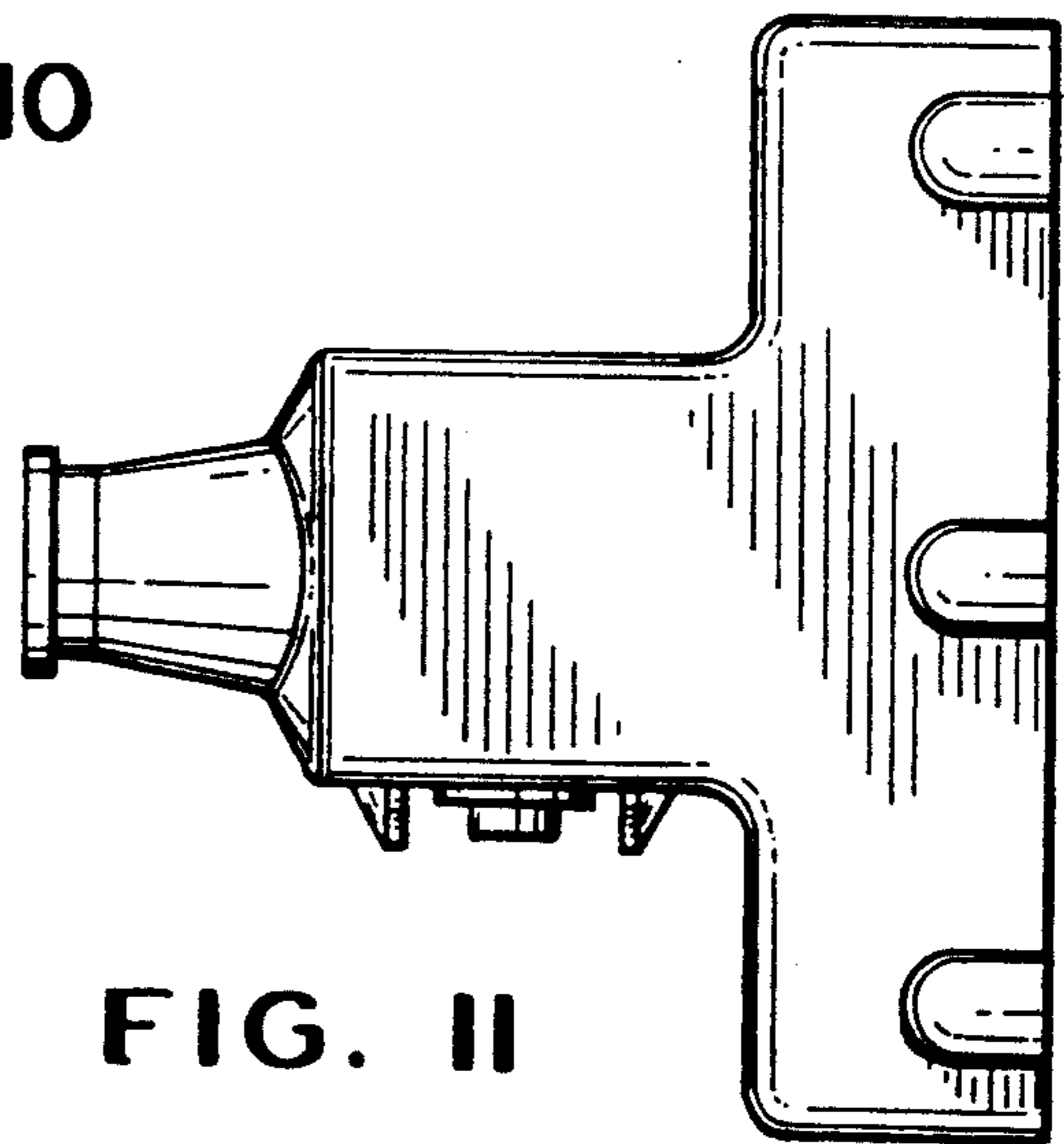

FIG. 11

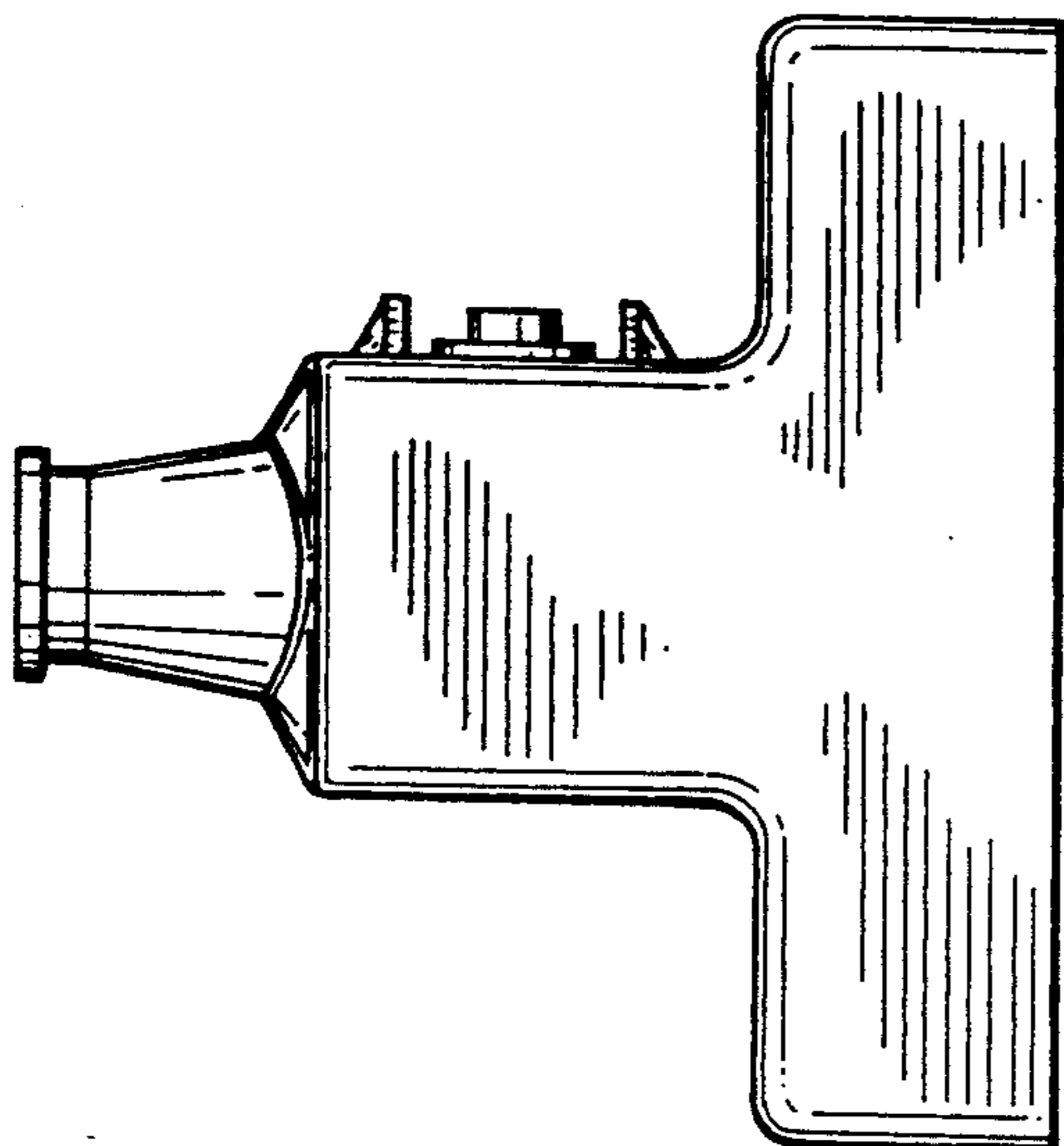

FIG. 12