



US00D332245S

United States Patent [19]

[11] Patent Number: Des. 332,245

Powell, Jr.

[45] Date of Patent: ** Jan. 5, 1993

[54] **PICKUP TRUCK WIND DEFLECTOR**

Attorney, Agent, or Firm—Leon Gilden

[76] Inventor: Leonard B. Powell, Jr., 7614 Cedar Rd., Baltimore, Md. 21222

[57] **CLAIM**

[**] Term: 14 Years

The ornamental design for a pickup truck wind deflector, as shown and described.

[21] Appl. No.: 600,092

DESCRIPTION

[22] Filed: Oct. 19, 1990

[52] U.S. Cl. D12/181; D12/156

[58] Field of Search D12/156, 181; 296/180.1, 180.2, 10, 26, 99.1, 102; 280/756

[56] **References Cited**

U.S. PATENT DOCUMENTS

- D. 286,143 10/1986 Lund D12/156
- 4,202,579 5/1980 Berggren D12/156

Primary Examiner—James M. Gandy

FIG. 1 is a front elevational view of the pickup truck wind deflector showing my new design;
 FIG. 2 is a rear elevational view thereof;
 FIG. 3 is a left side elevational view thereof;
 FIG. 4 is a right side elevational view thereof;
 FIG. 5 is a bottom plan view thereof;
 FIG. 6 is a top plan view thereof; and,
 FIG. 7 is a perspective view thereof on a reduced scale, it being understood that the broken line showing of a pickup truck is for illustrative purposes only and forms no part of the claimed design.

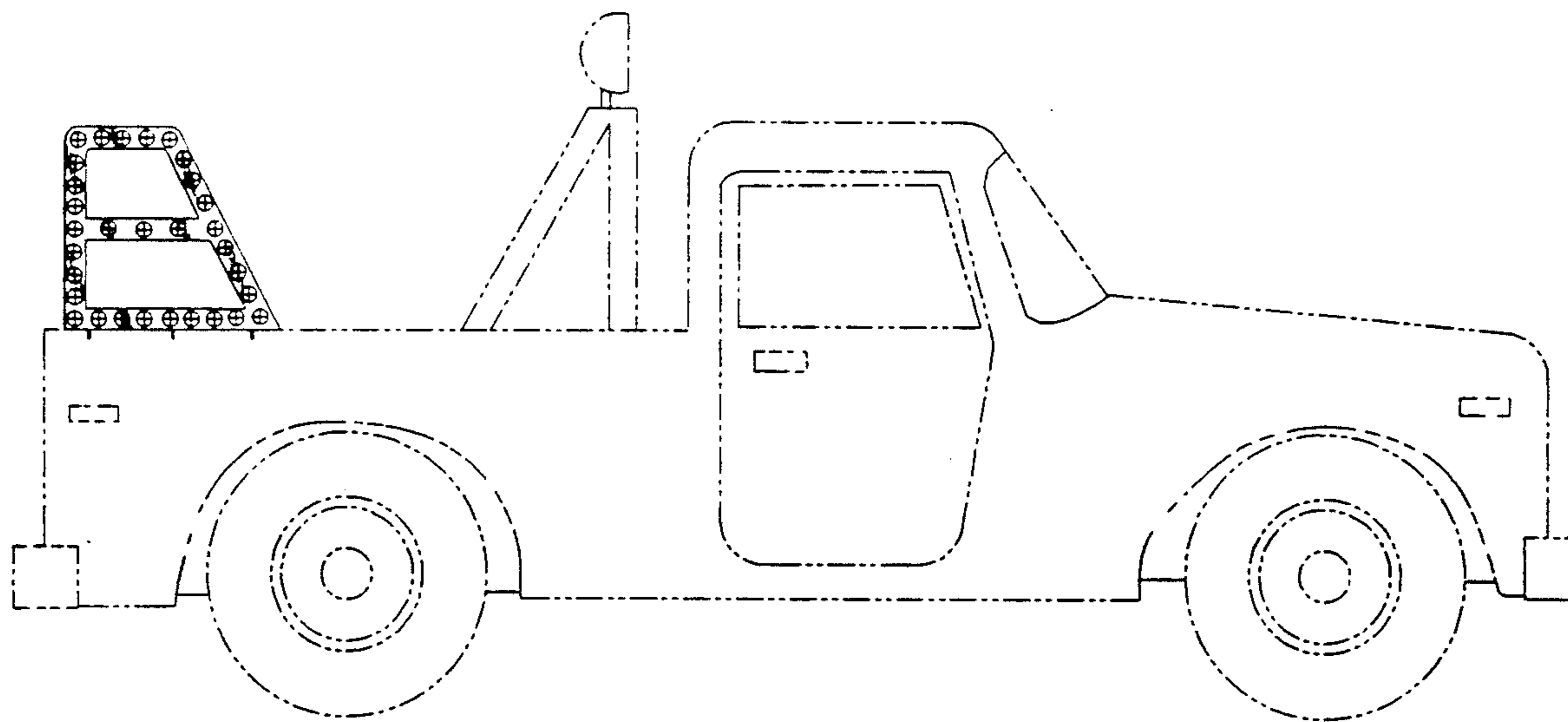

FIG. 1

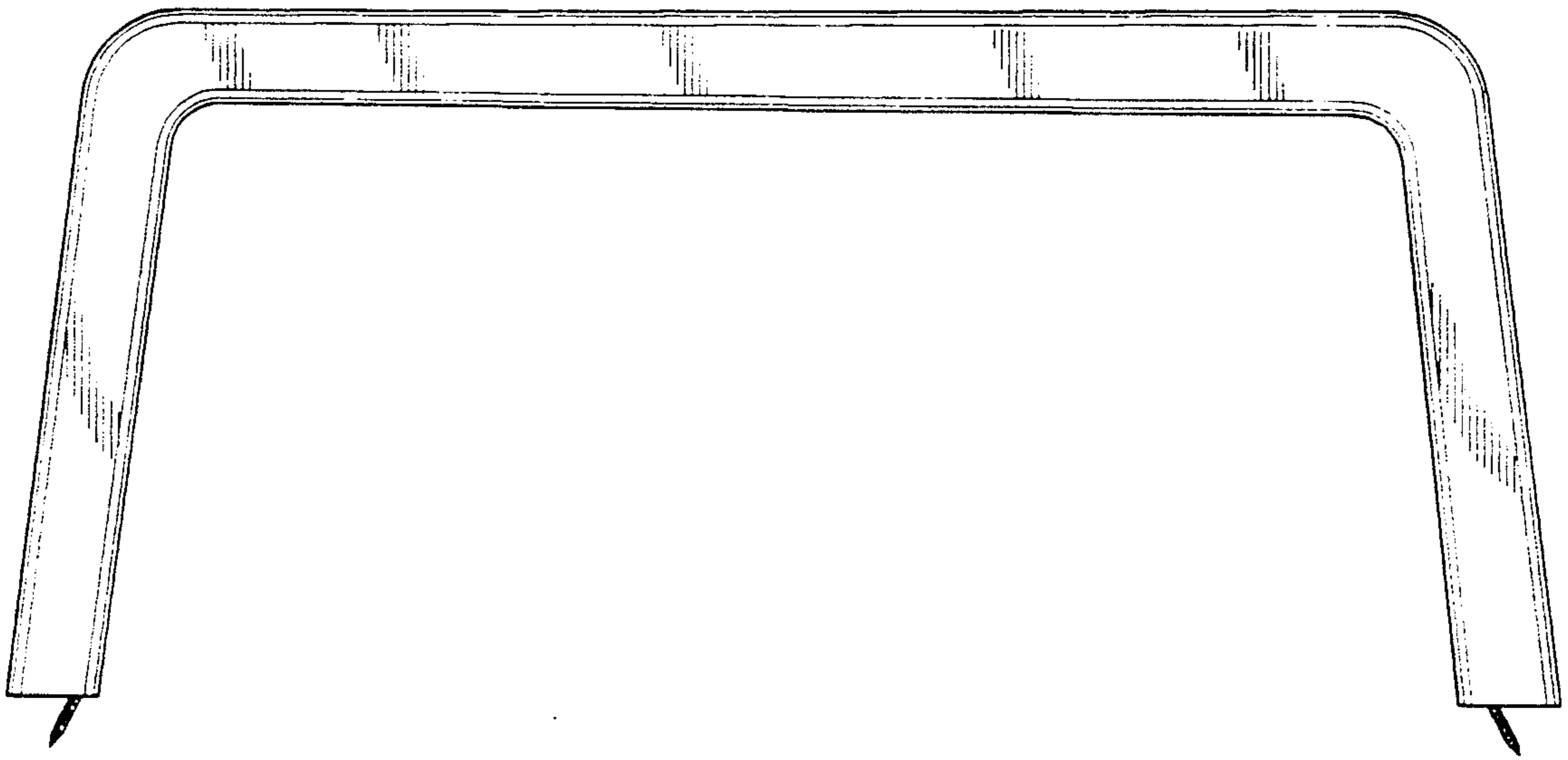

FIG. 2

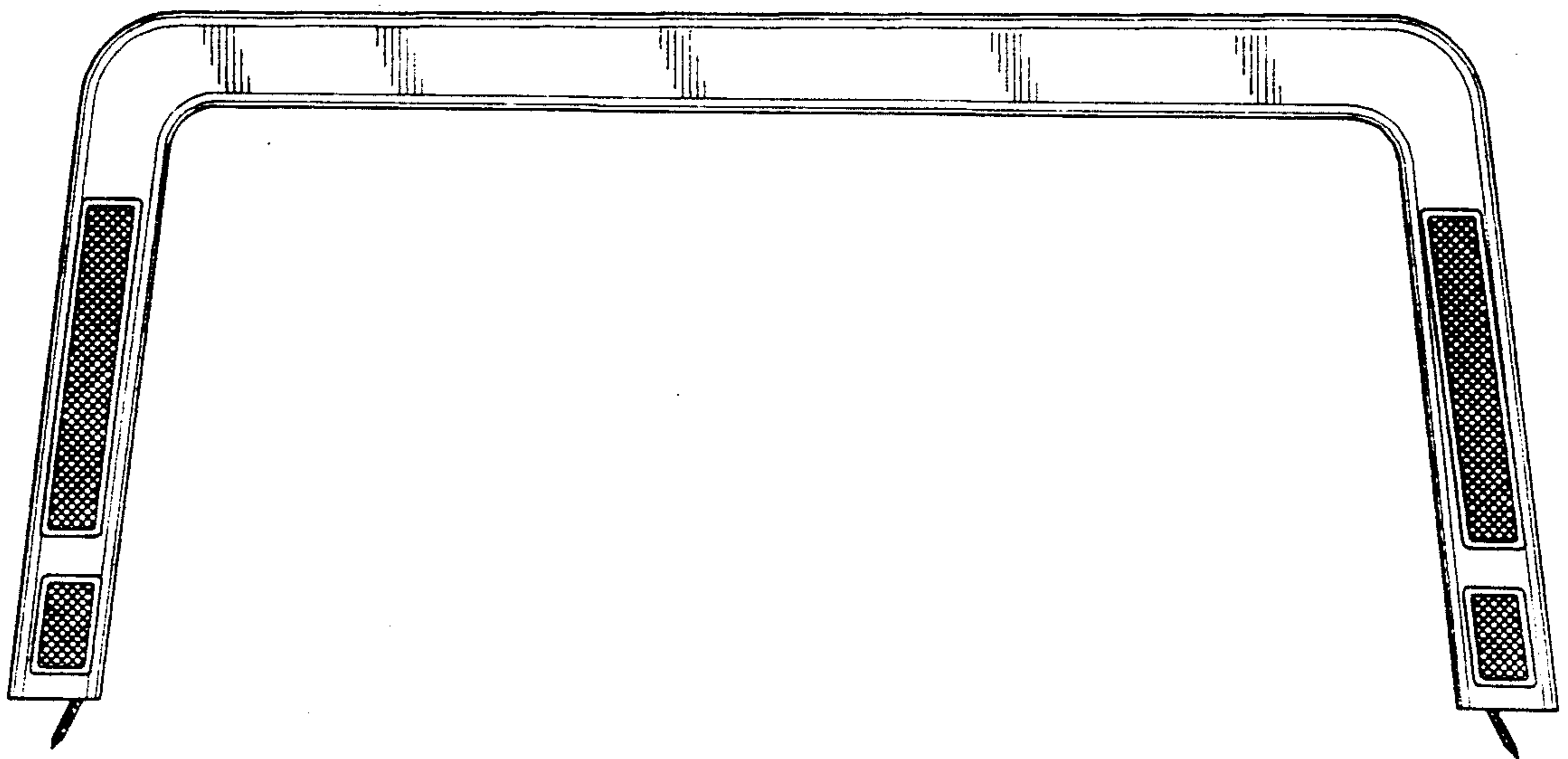

FIG. 3

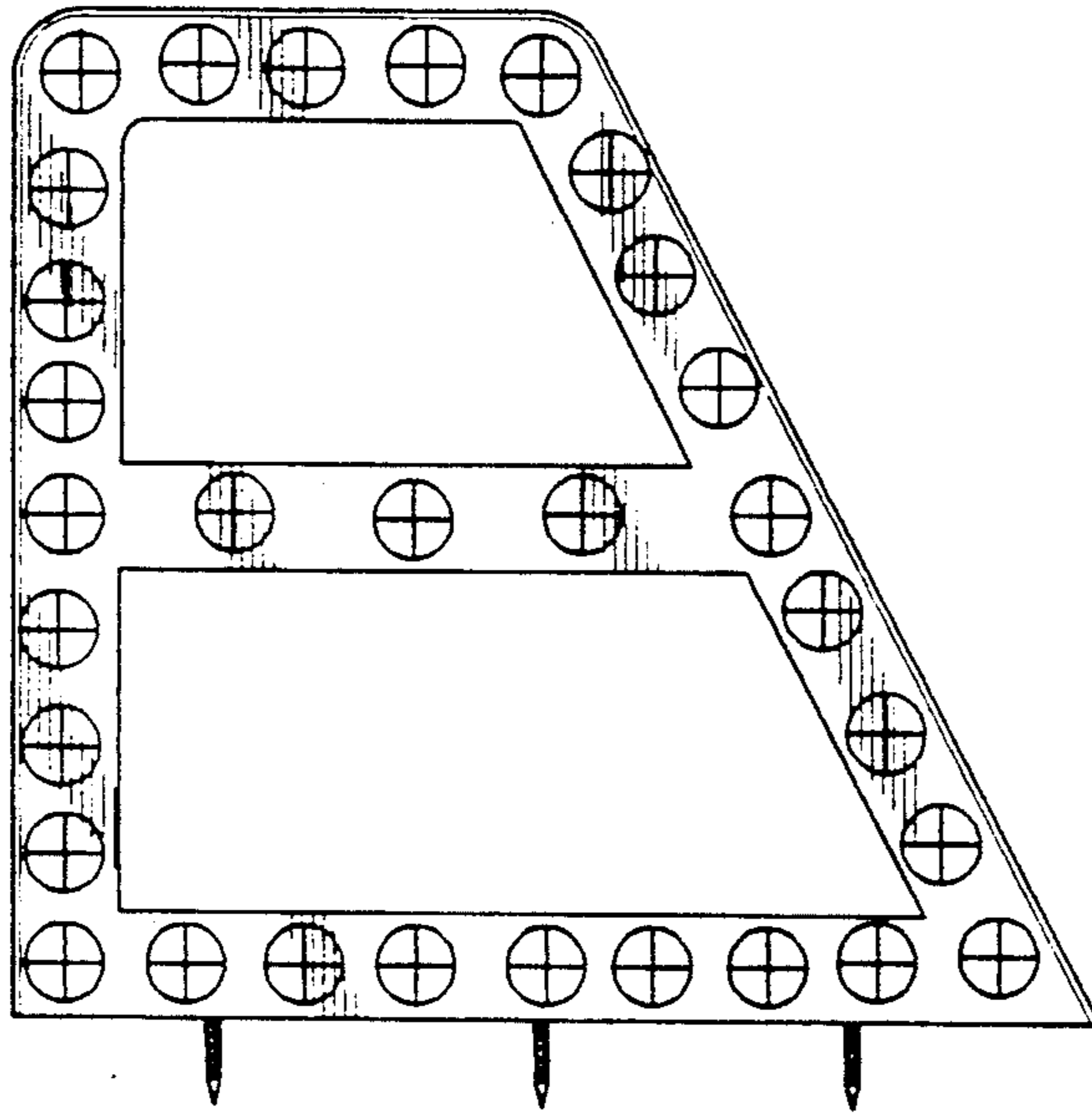

FIG. 4

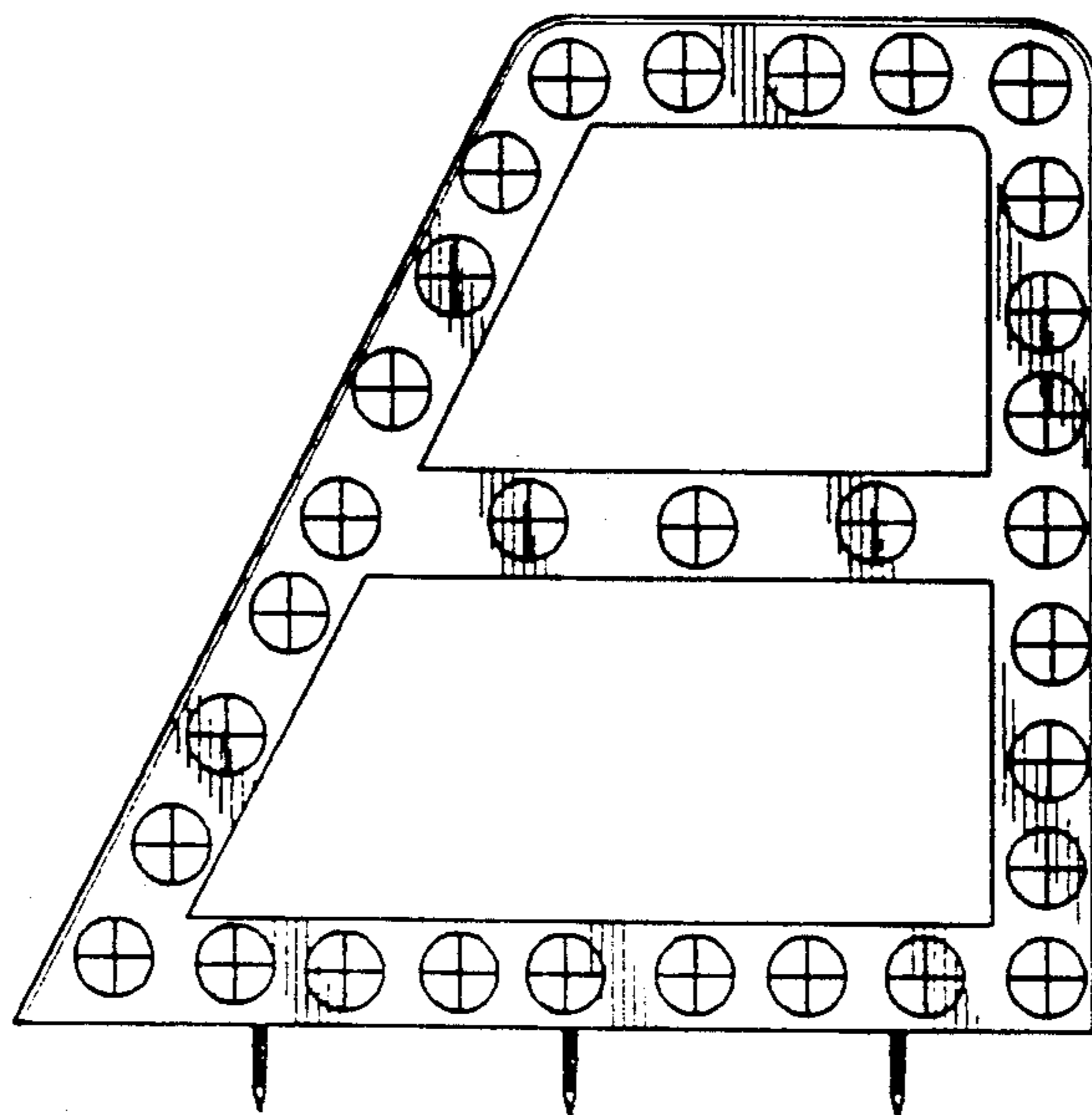

FIG. 5

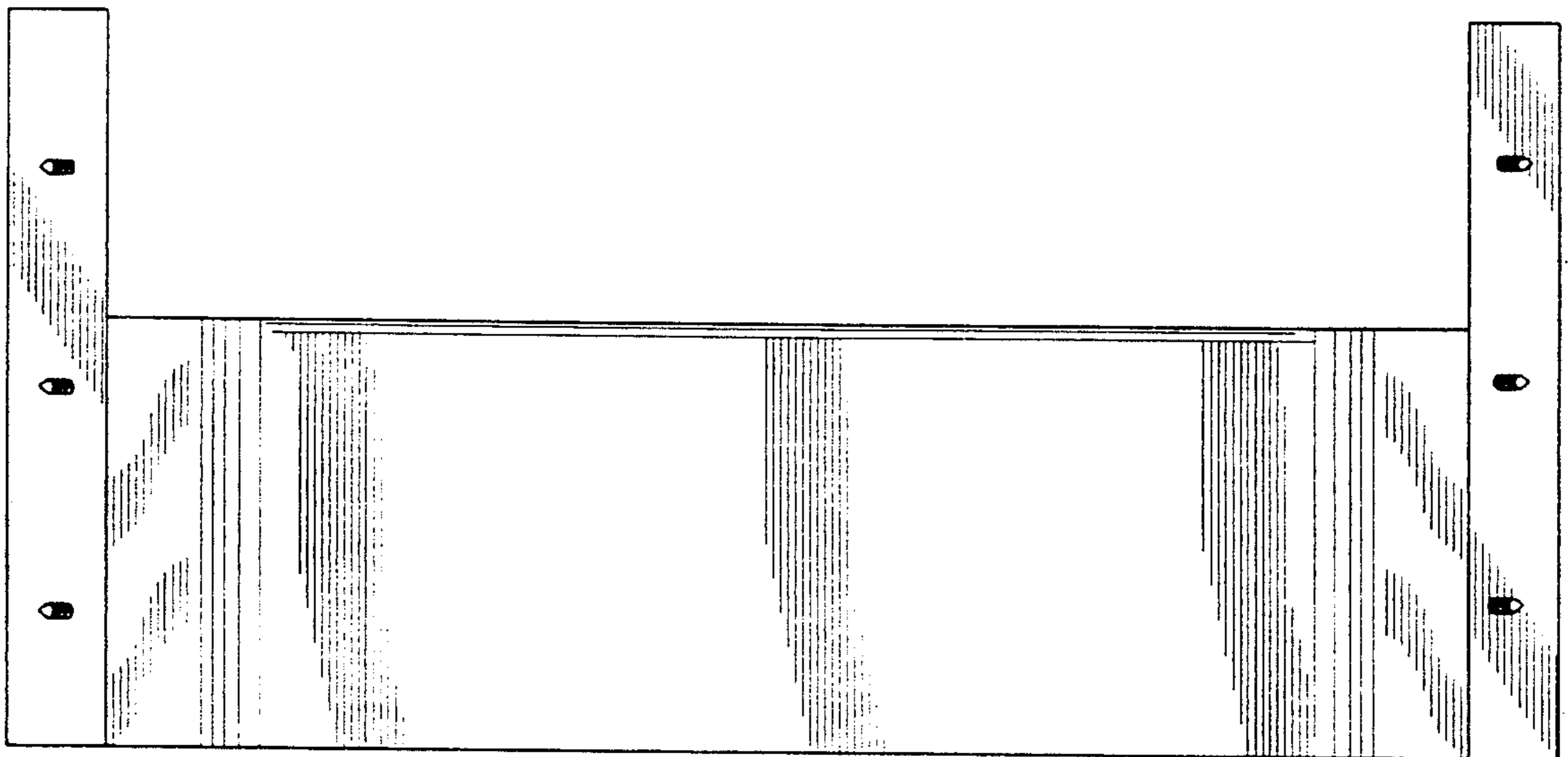

FIG. 6

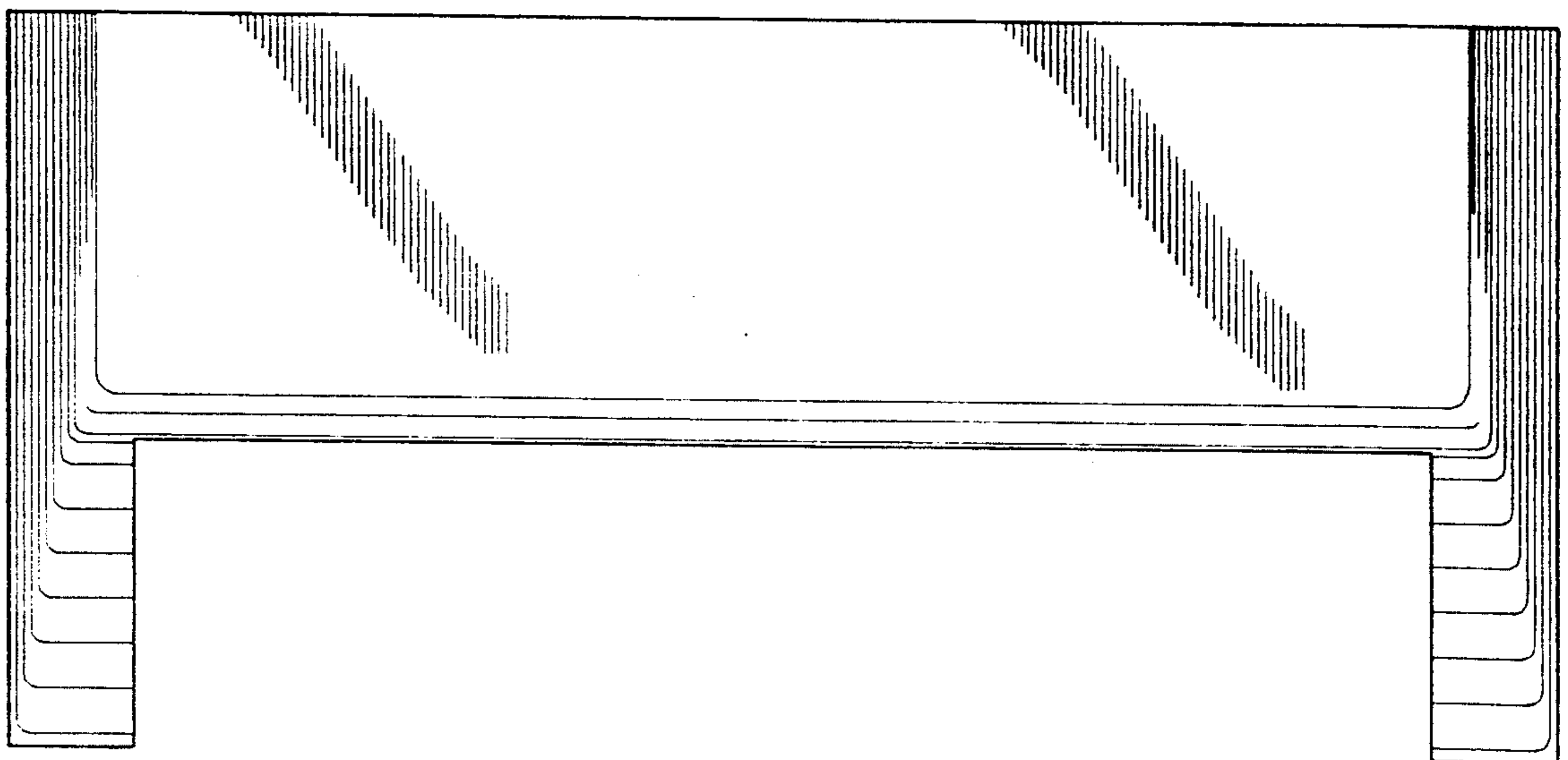

FIG. 7

