



US00D332219S

United States Patent [19]

Serna

[11] Patent Number: **Des. 332,219**

[45] Date of Patent: **** Jan. 5, 1993**

[54] GIFT BOX

4,910,913 3/1990 Streeter 229/108 X

[76] Inventor: **Robert Serna**, 5019 E. Nevada,
Fresno, Calif. 93727

OTHER PUBLICATIONS

Packaging 1962, p. 165, bottom left of the page.
Packaging 1962, p. 288, item #1016 & 1013.

[**] Term: **14 Years**

Primary Examiner—Bernard Ansher
Assistant Examiner—Prabhakar Deshmukh
Attorney, Agent, or Firm—Mark D. Miller

[21] Appl. No.: **660,588**

[22] Filed: **Feb. 25, 1991**

[52] U.S. Cl. **D9/430**

[58] Field of Search D9/430, 431, 432, 414,
D9/346; 229/108, 108.1, 111, 115, 114, DIG. 4,
8; 206/457, 45.25

[57] CLAIM

The ornamental design for gift box, as shown and described.

[56] References Cited

DESCRIPTION

U.S. PATENT DOCUMENTS

715,789	12/1902	Haas	229/111 X
892,463	7/1908	Stonebarger	229/108.1 X
2,453,973	11/1948	Coats	229/110 X
2,584,379	2/1952	Chmielewski	229/115 X
4,063,679	12/1977	Henry	229/108.1
4,173,655	11/1979	Capo	229/111 X
4,260,097	4/1981	Nold	229/108

FIG. 1 is a perspective view of a gift box showing my new design;
FIG. 2 is a top plan view thereof;
FIG. 3 is a bottom plan view thereof;
FIG. 4 is a front elevational view thereof;
FIG. 5 is a rear elevational view thereof;
FIG. 6 is a left side elevational view thereof; and,
FIG. 7 is a right side elevational view thereof.

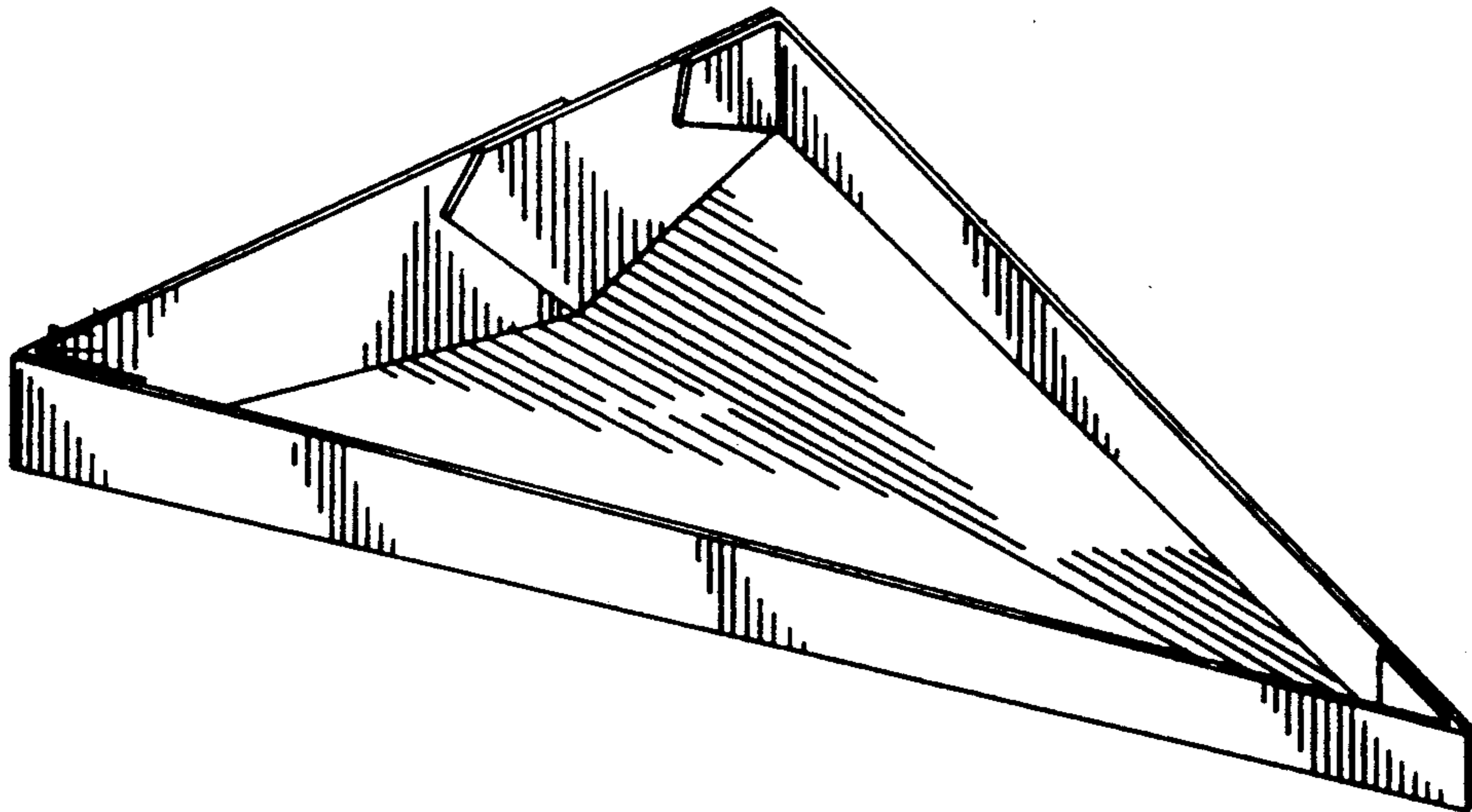

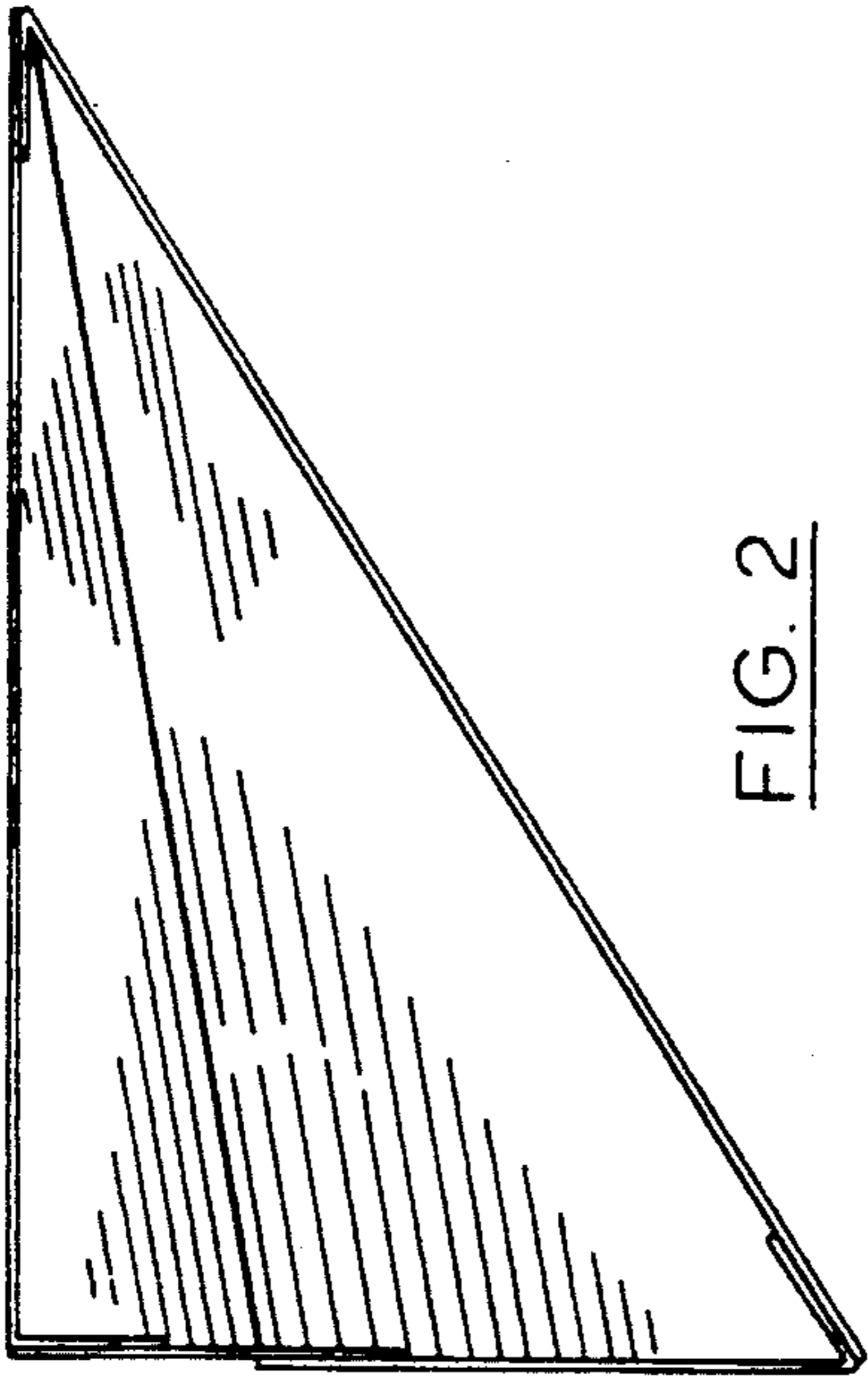

FIG. 2

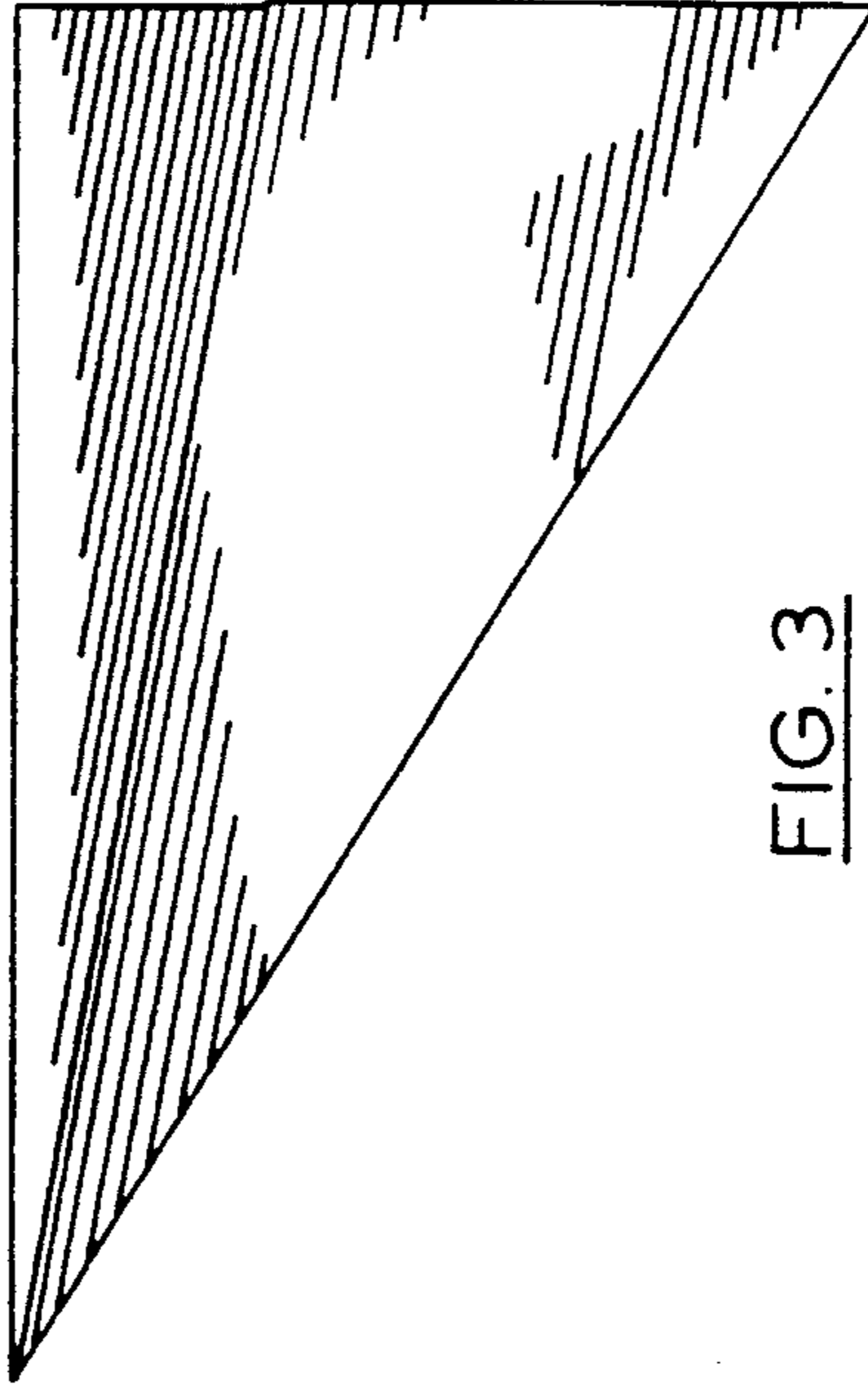

FIG. 3

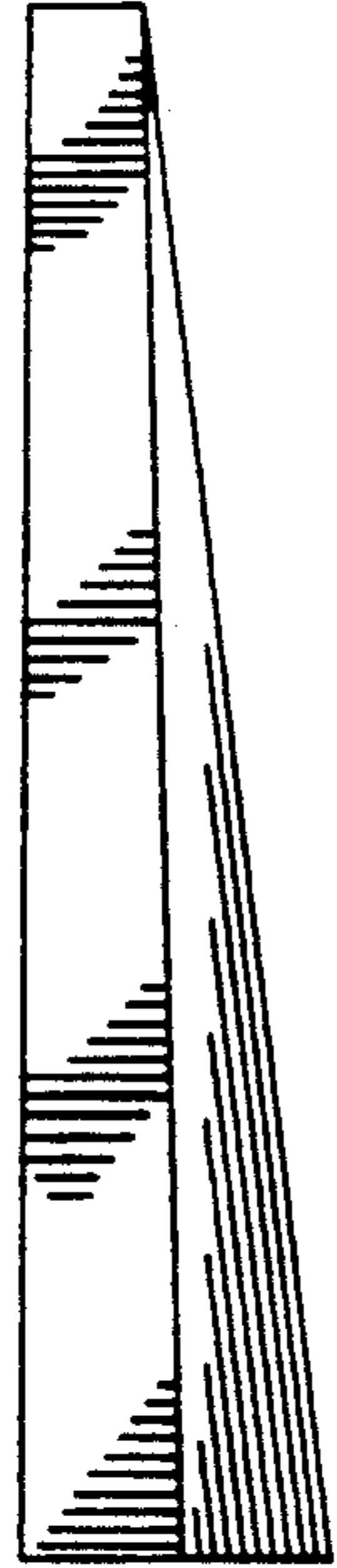

FIG. 4

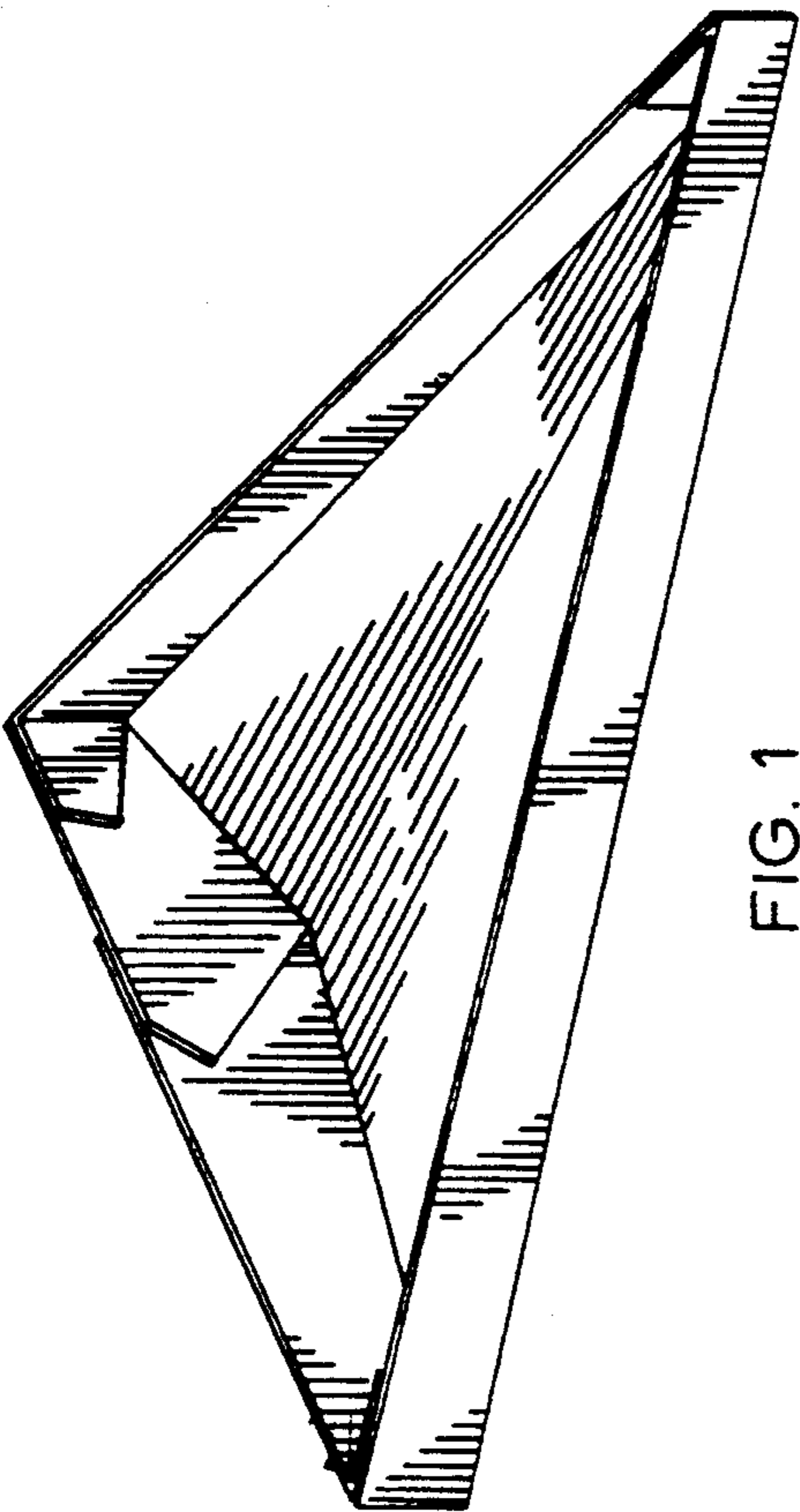

FIG. 1

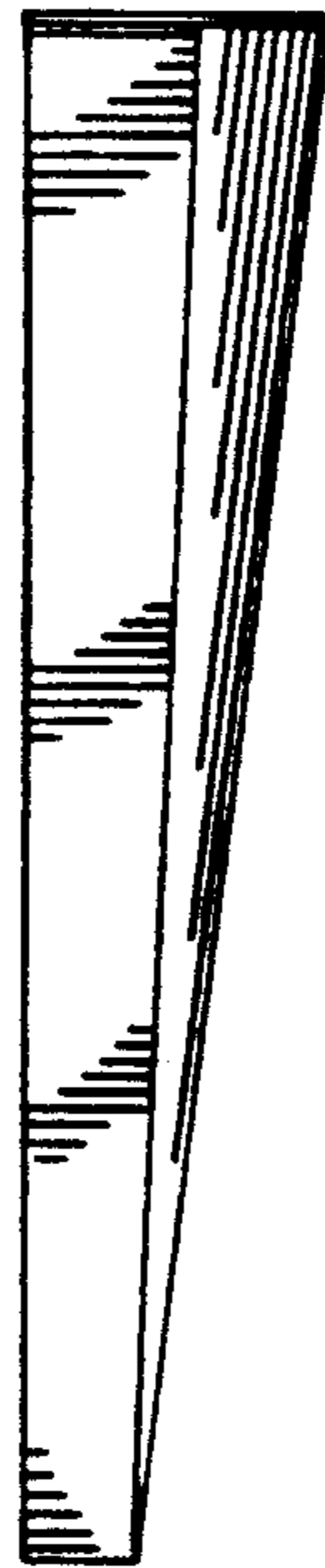

FIG. 5

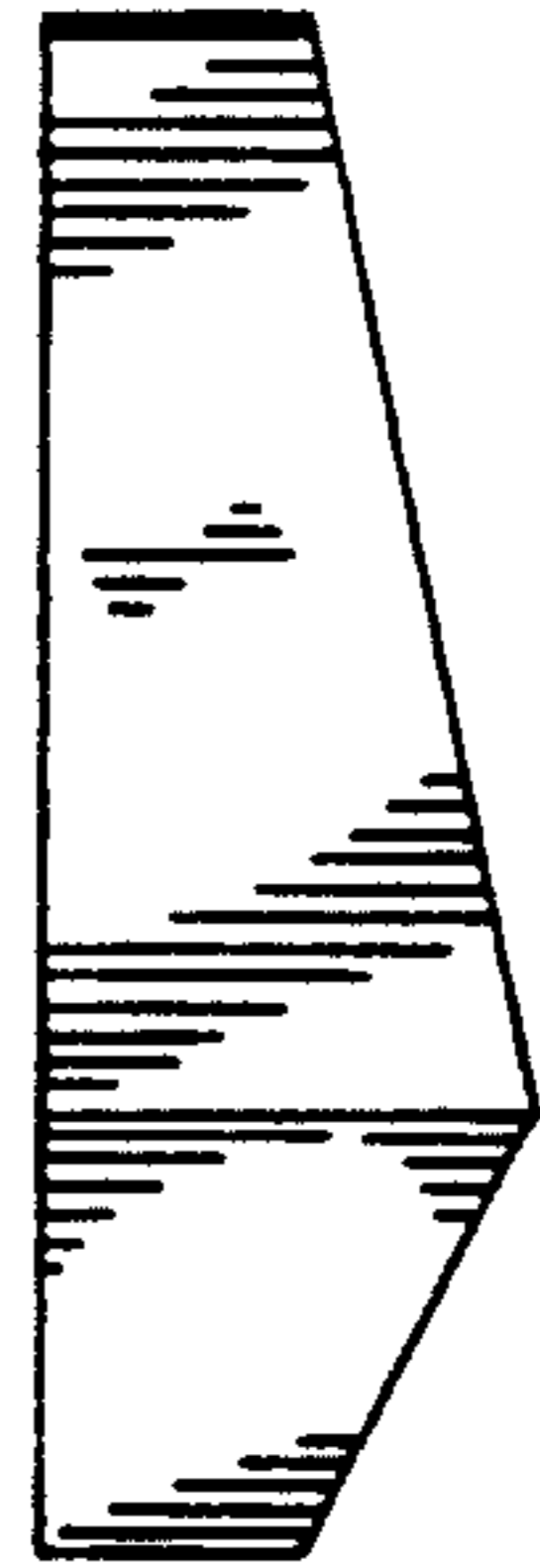

FIG. 7

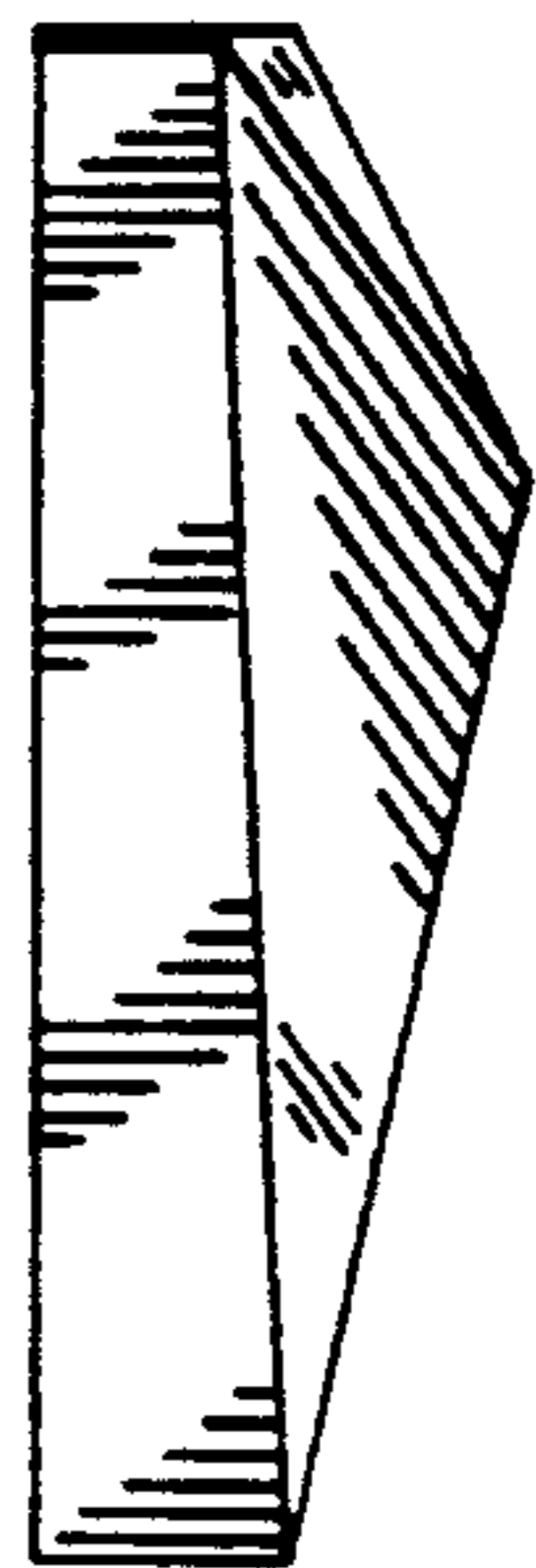

FIG. 6