



US00D332197S

United States Patent [19]

[11] Patent Number: **Des. 332,197**

Chase

[45] Date of Patent: **** Jan. 5, 1993**

[54] WALL MOUNTED FOLDING DIAPER CHANGING SUPPORT

[76] Inventor: **Al L. Chase**, R.R. 1, Box 170, Freedom, Me. 04941-9705

[**] Term: **14 Years**

[21] Appl. No.: **604,594**

[22] Filed: **Oct. 26, 1990**

[52] U.S. Cl. **D6/555**

[58] Field of Search **D6/555, 553, 559, 567, D6/574; 312/114, 126, 128-129, 204, 224, 231, 234, 242, 245; 211/13, 34-35, 65, 69.1, 70.6, 70.7**

[56] References Cited

U.S. PATENT DOCUMENTS

D. 284,723	7/1986	Morris et al.	D6/574 X
D. 287,800	1/1987	Lance	D6/559
D. 314,112	1/1991	Dainty	D6/555
4,155,609	5/1979	Skafta et al.	312/245

Primary Examiner—Brian N. Vinson
Attorney, Agent, or Firm—Daniel H. Kane

[57] CLAIM

The ornamental design for a wall mounted folding diaper changing support, as shown and described.

DESCRIPTION

FIG. 1 is a front elevational view of a wall mounted folding diaper changing support showing my new design;

FIG. 2 is a rear elevational view thereof;

FIG. 3 is a reduced top, front, and left side perspective view thereof, shown in an opened position;

FIG. 4 is a front elevational view thereof, shown in an opened position;

FIG. 5 is a top plan view thereof, shown in an opened position;

FIG. 6 is a top plan view thereof;

FIG. 7 is a bottom plan view thereof;

FIG. 8 is a left side elevational view thereof;

FIG. 9 is a right side elevational view thereof;

FIG. 10 is a top, front, and left side perspective view thereof;

FIG. 11 is a left side elevational view thereof, shown in an opened position, the right side being a mirror image of that shown; and,

FIG. 12 is a top, rear, and right side perspective view thereof.

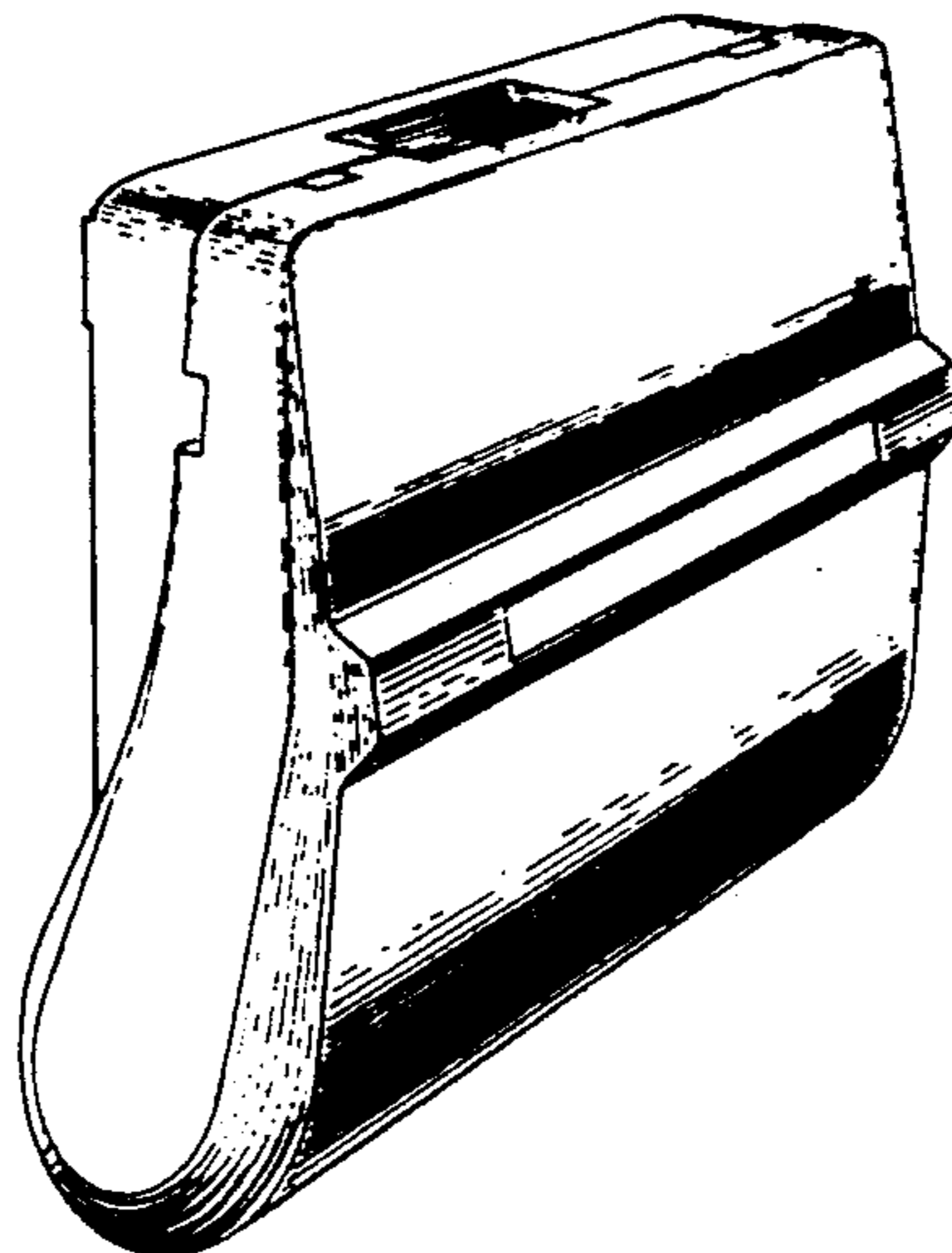
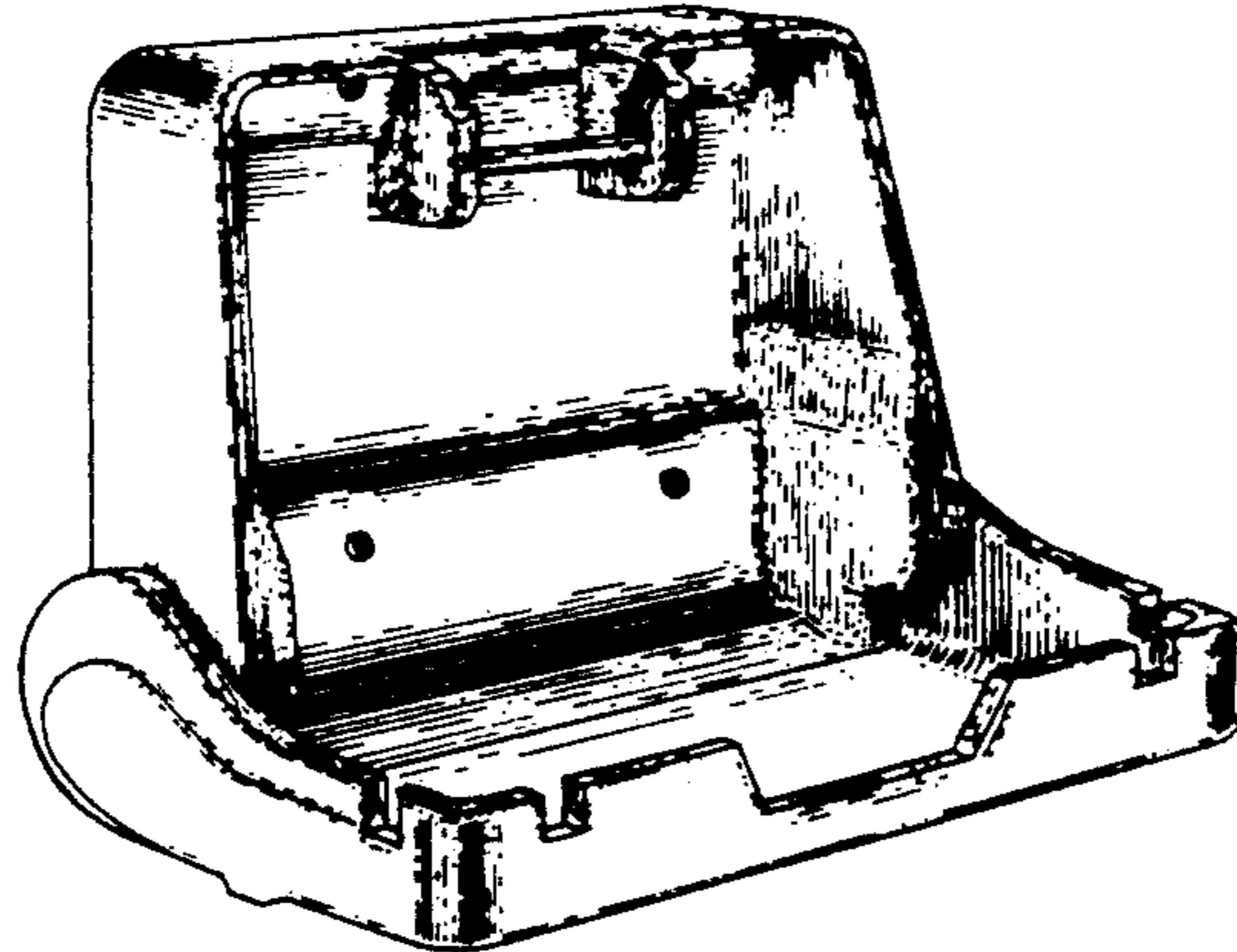

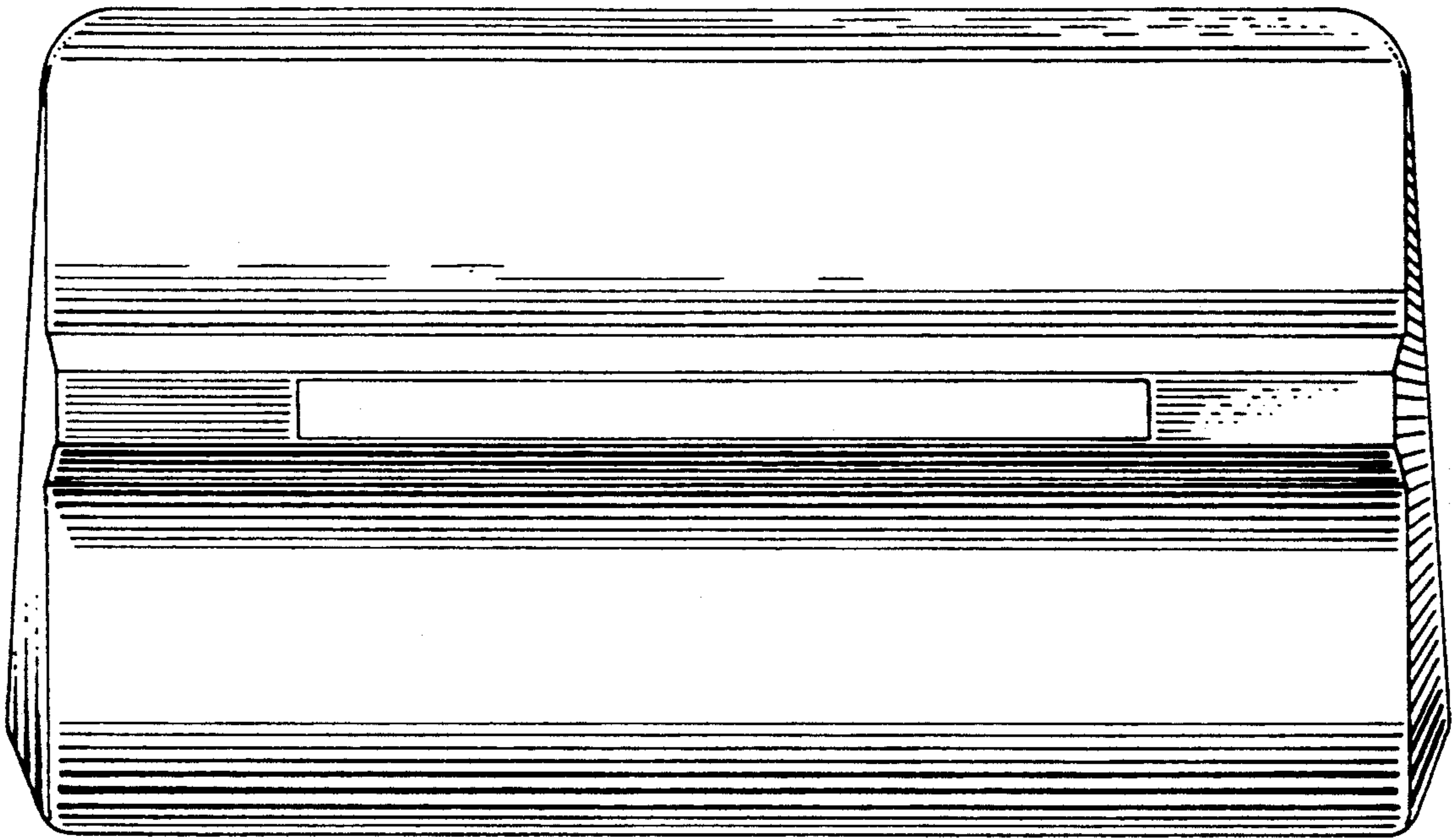

FIG 1

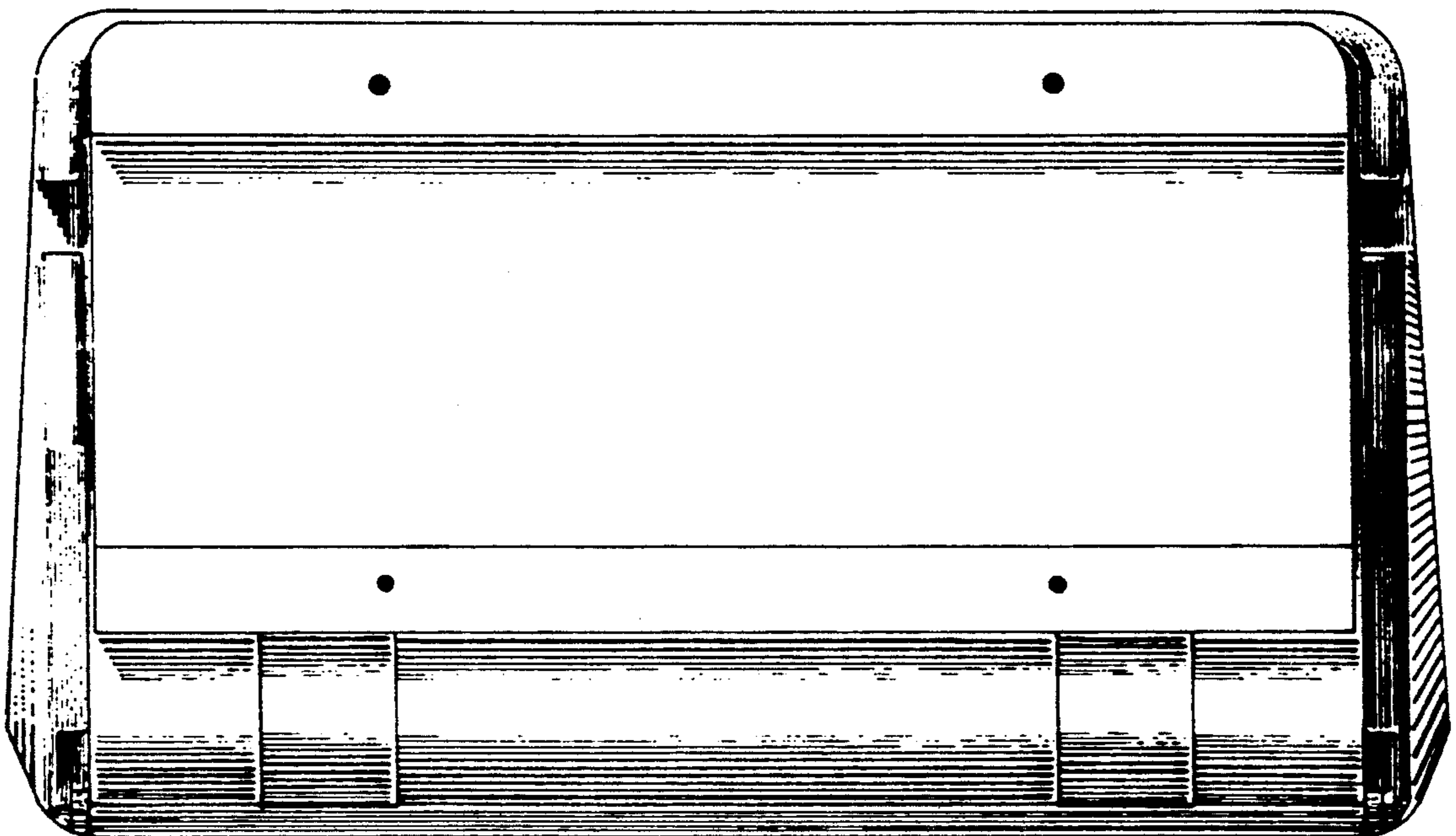

FIG 2

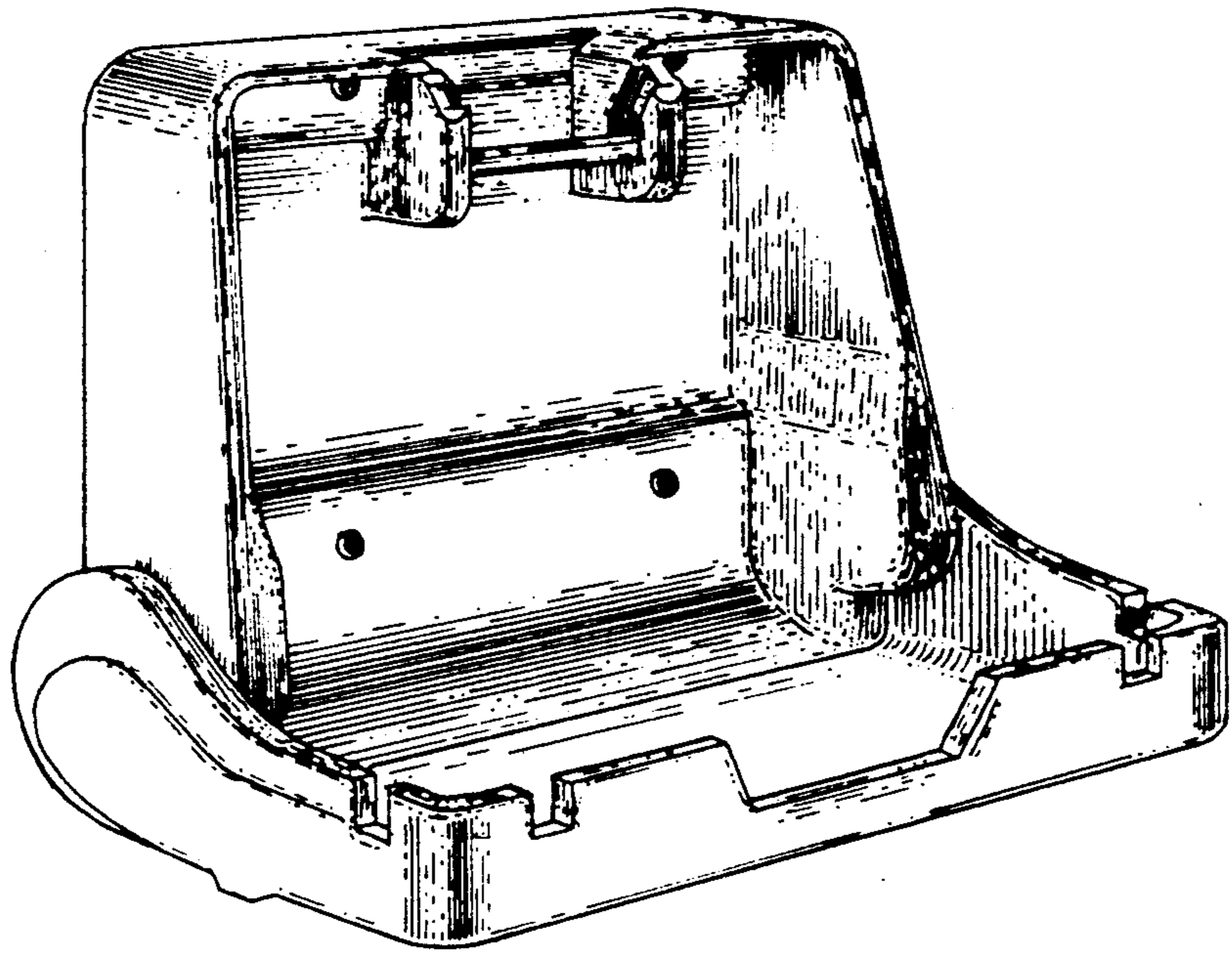

FIG 3

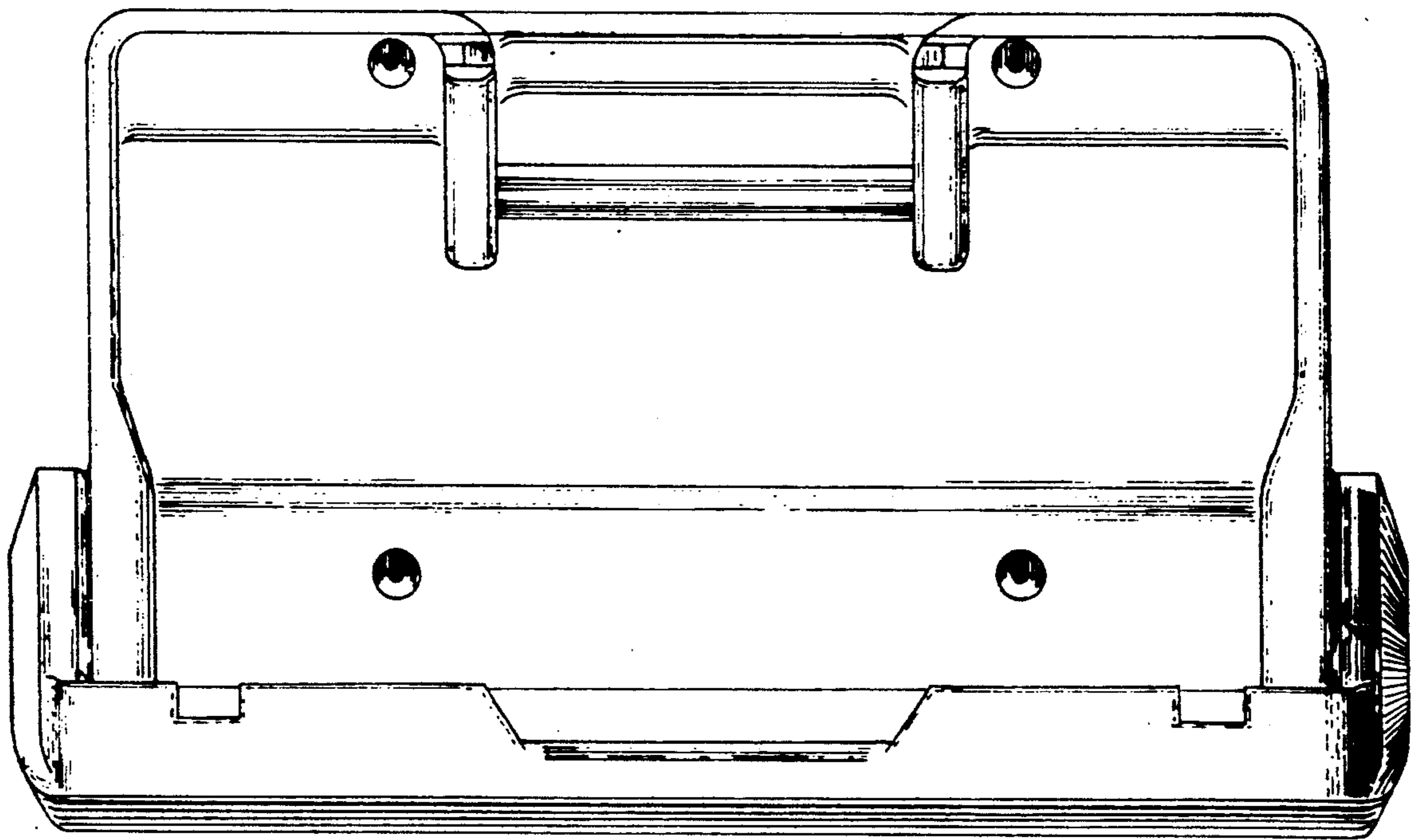

FIG 4

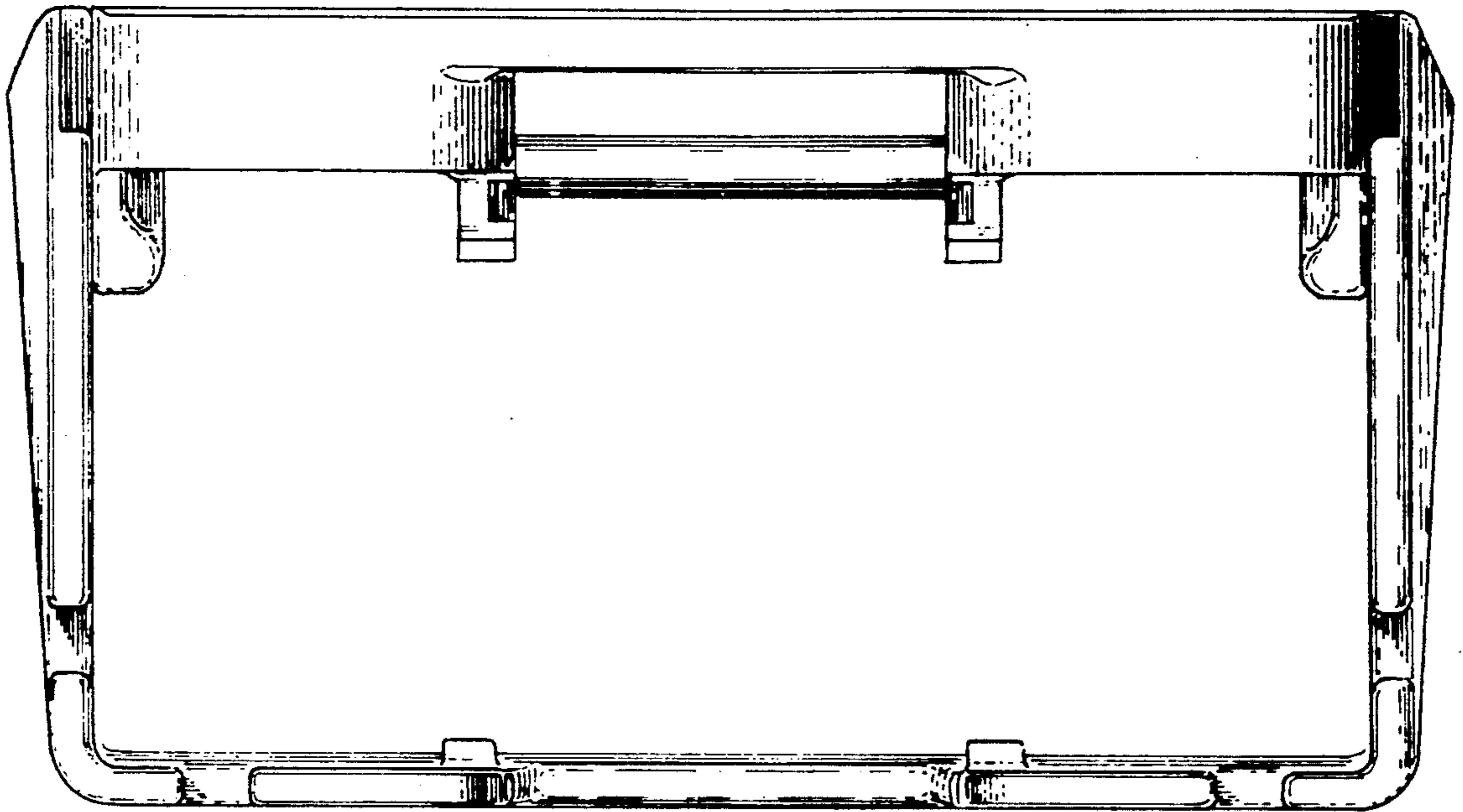

FIG 5

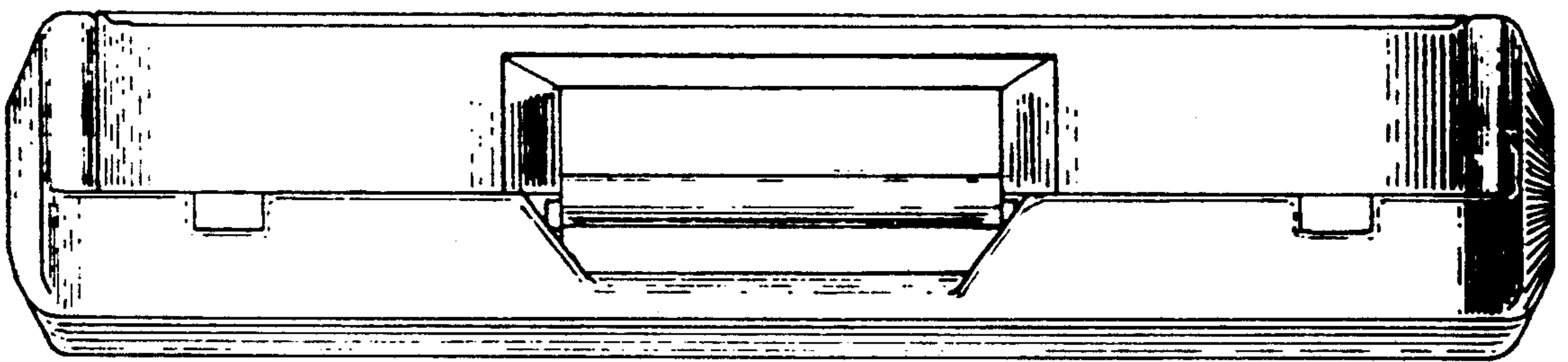

FIG 6

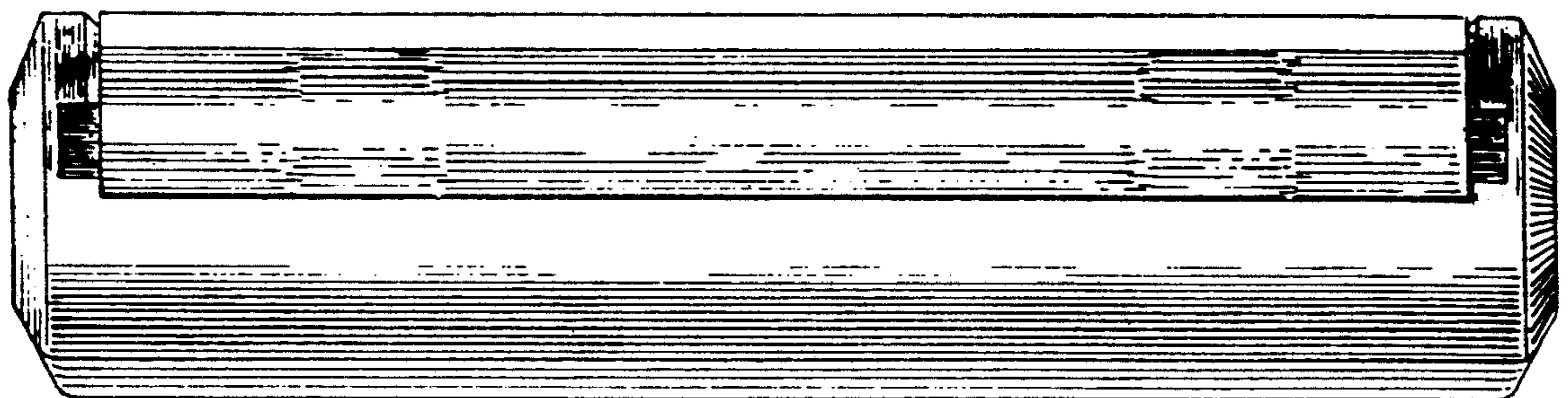

FIG 7

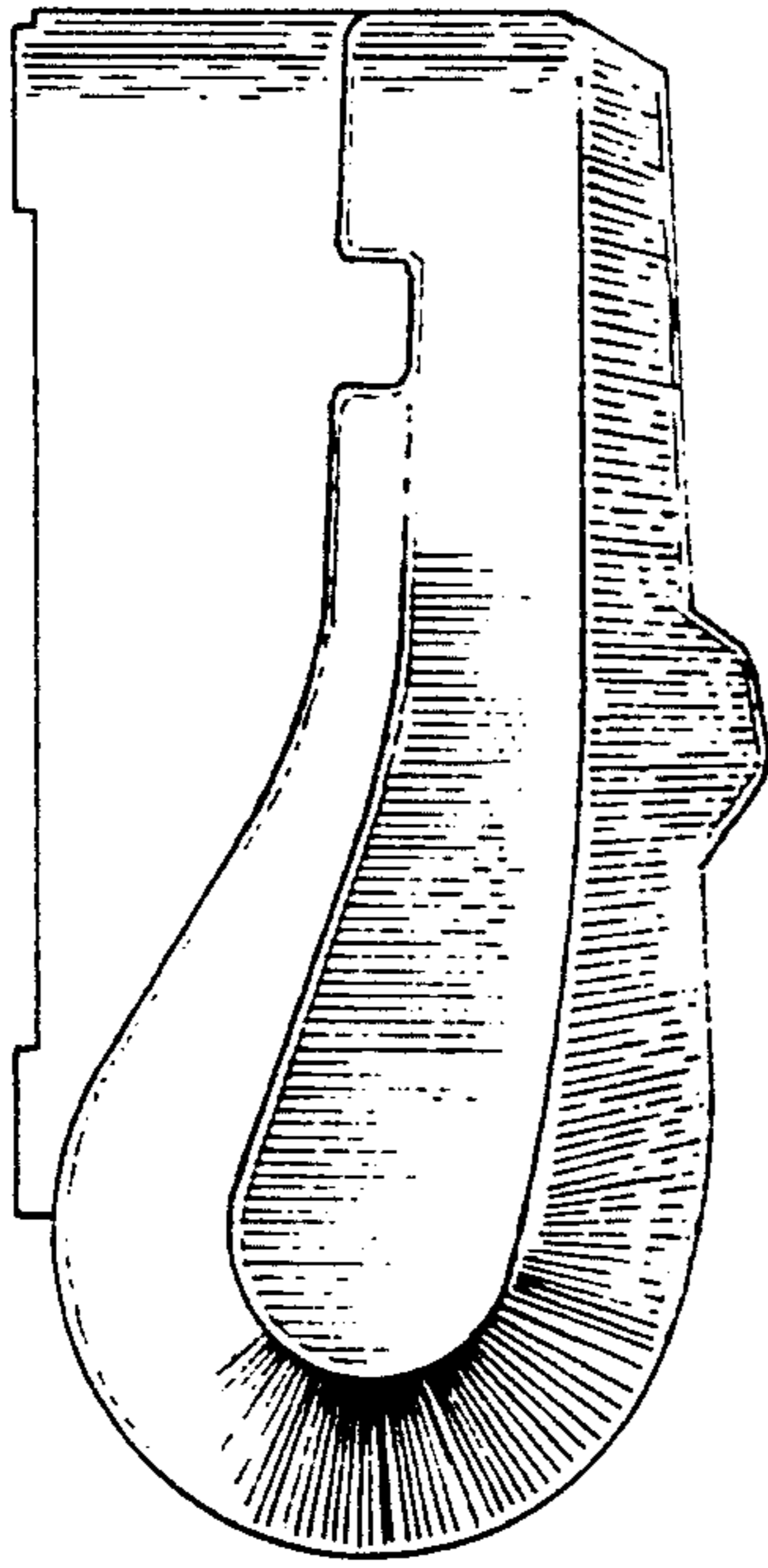

FIG 8

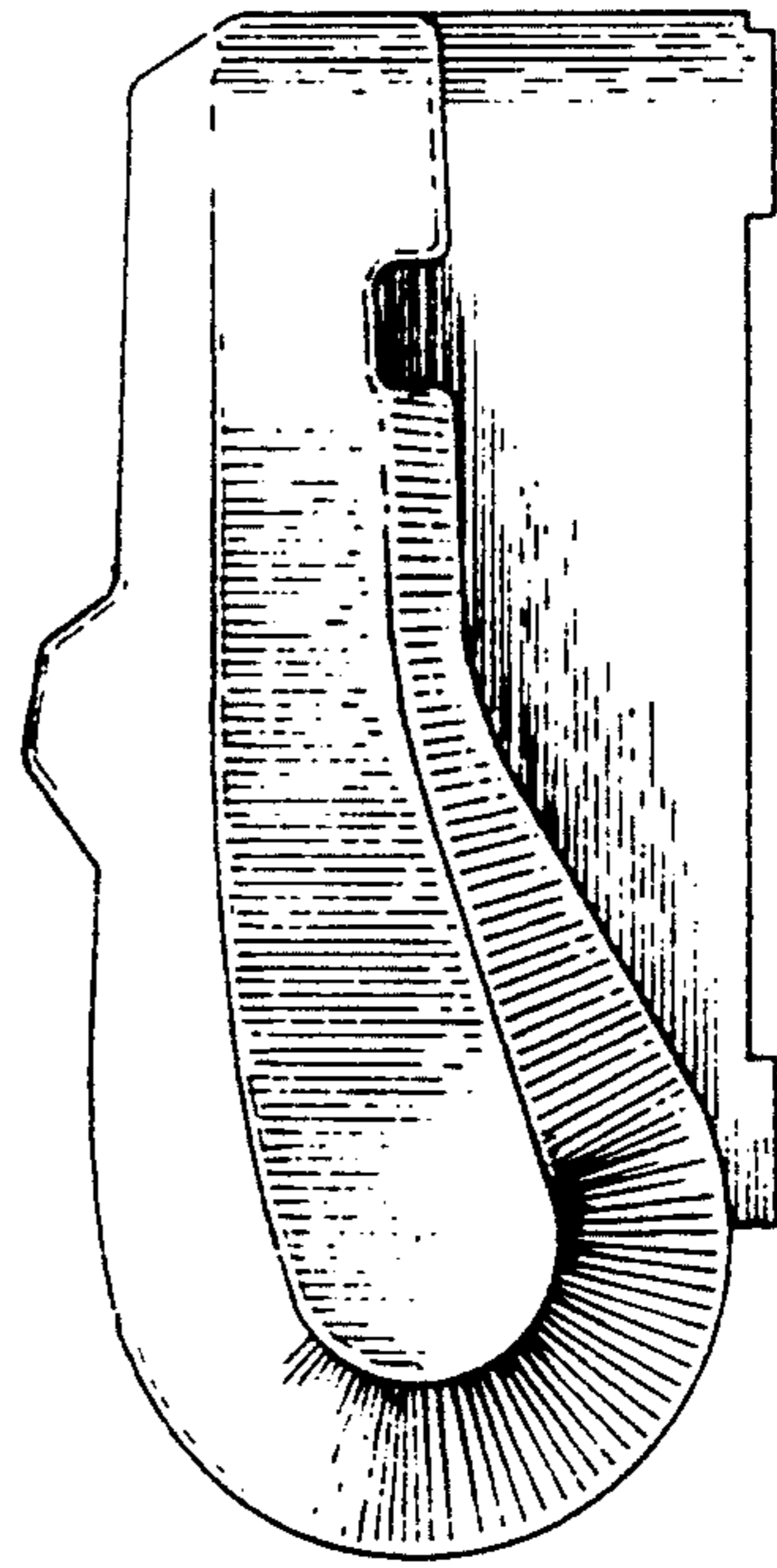

FIG 9

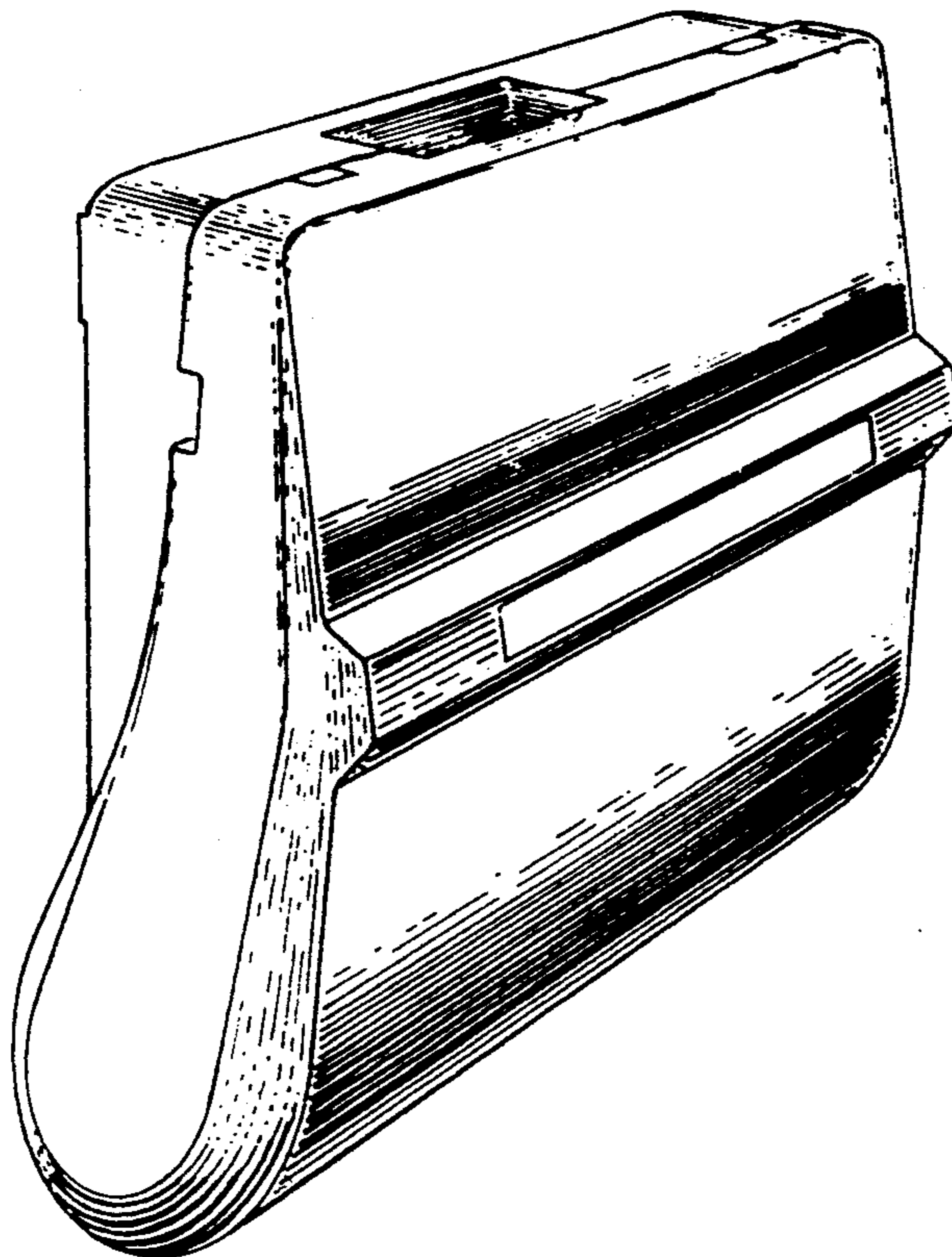

FIG 10

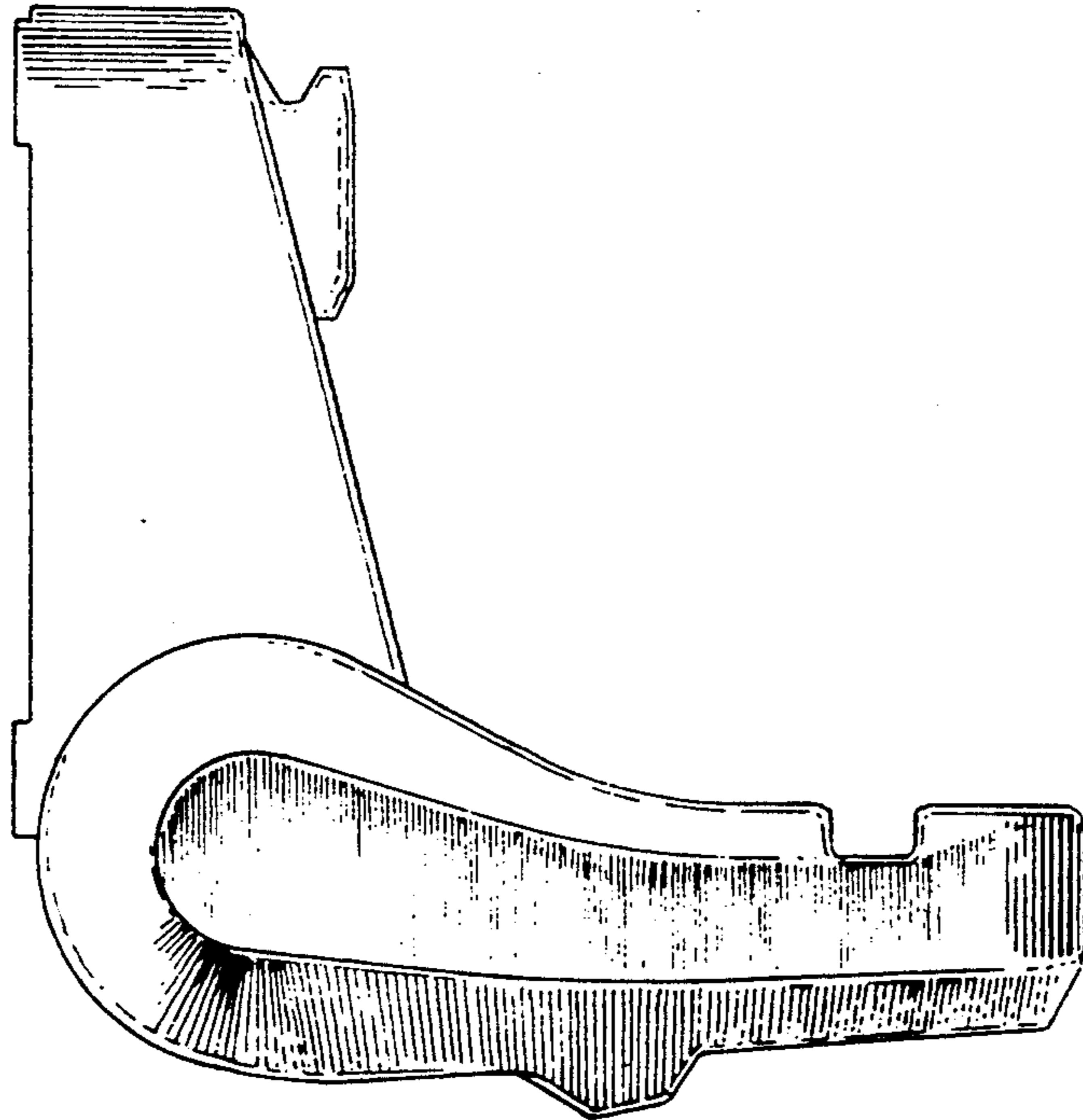

FIG II

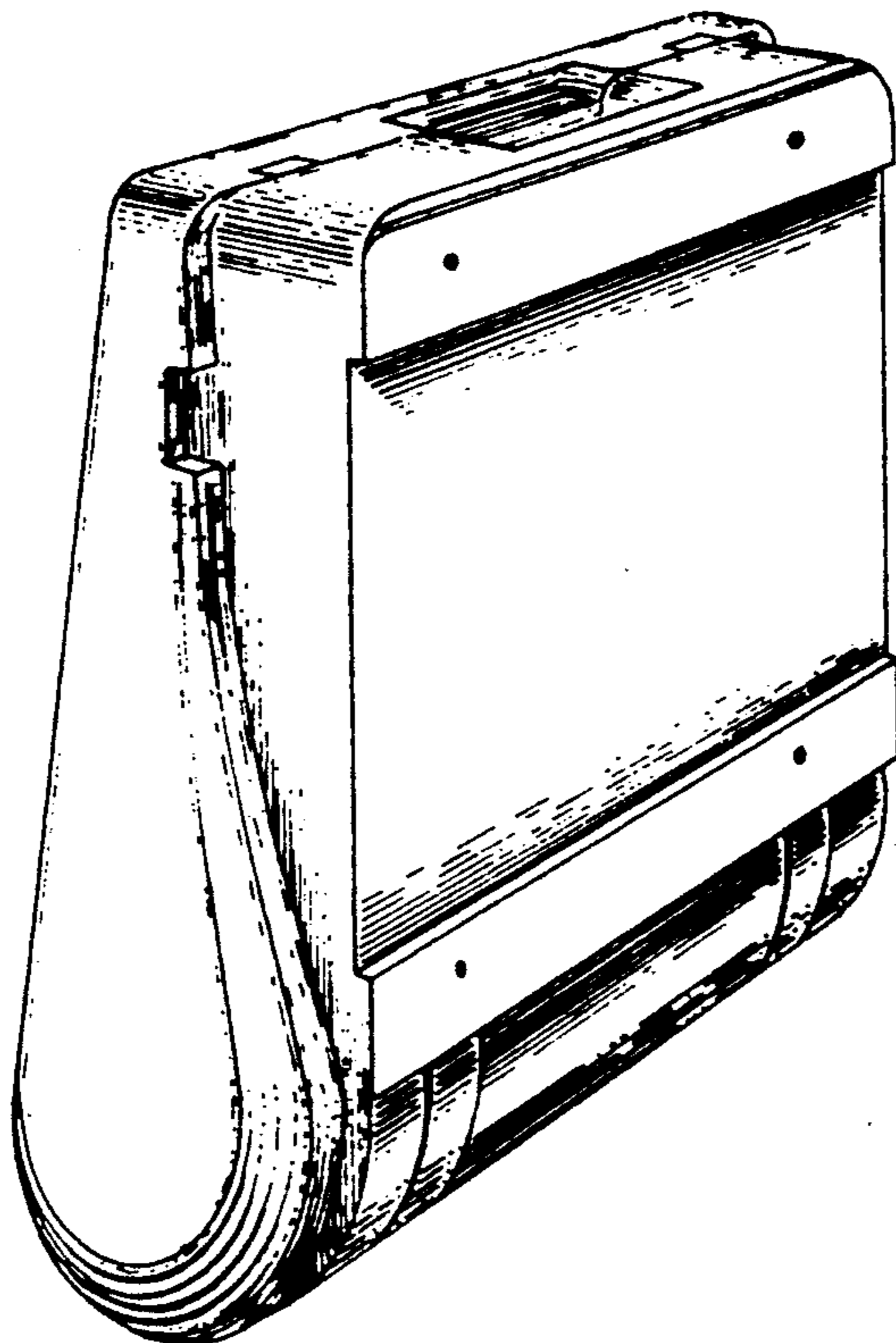

FIG 12