



US00D332167S

United States Patent [19]

[11] Patent Number: **Des. 332,167**

Jackman

[45] Date of Patent: **** Dec. 29, 1992**

[54] **MAILBOX WITH DELIVERY INDICATOR**

3,294,057 12/1966 Feil D99/32
3,958,752 5/1976 Pieszchala D99/32
3,968,928 7/1976 Caldwell D99/32

[76] Inventor: **John R. Jackman**, P.O. Box 394,
Superior, Mont. 59872

Primary Examiner—Wallace R. Burke
Assistant Examiner—Marcus Jackson
Attorney, Agent, or Firm—Leon Gilden

[**] Term: **14 Years**

[21] Appl. No.: **564,951**

[57] **CLAIM**

[22] Filed: **Aug. 9, 1990**

The ornamental design for a mailbox with delivery indicator, as shown and described.

[52] U.S. Cl. **D99/29**

[58] Field of Search D10/104, 109, 111, 121;
116/200, 201, 203, 205; 232/36, 37, 1 R, 34, 35,
17; D99/29, 30, 31, 32, 33

DESCRIPTION

[56] **References Cited**

U.S. PATENT DOCUMENTS

D. 271,476 11/1983 Gaudet, Sr. D10/109
D. 301,928 6/1989 Hogge D99/29
D. 306,228 2/1990 Hoffman et al. D99/29
1,543,072 6/1925 Fenner D99/32

FIG. 1 is a front elevational view of the mailbox with delivery indicator showing my new design;
FIG. 2 is a rear elevational view thereof;
FIG. 3 is a left side elevational view thereof;
FIG. 4 is a right side elevational view thereof;
FIG. 5 is a top plan view thereof;
FIG. 6 is a bottom plan view thereof; and,
FIG. 7 is a perspective view thereof.

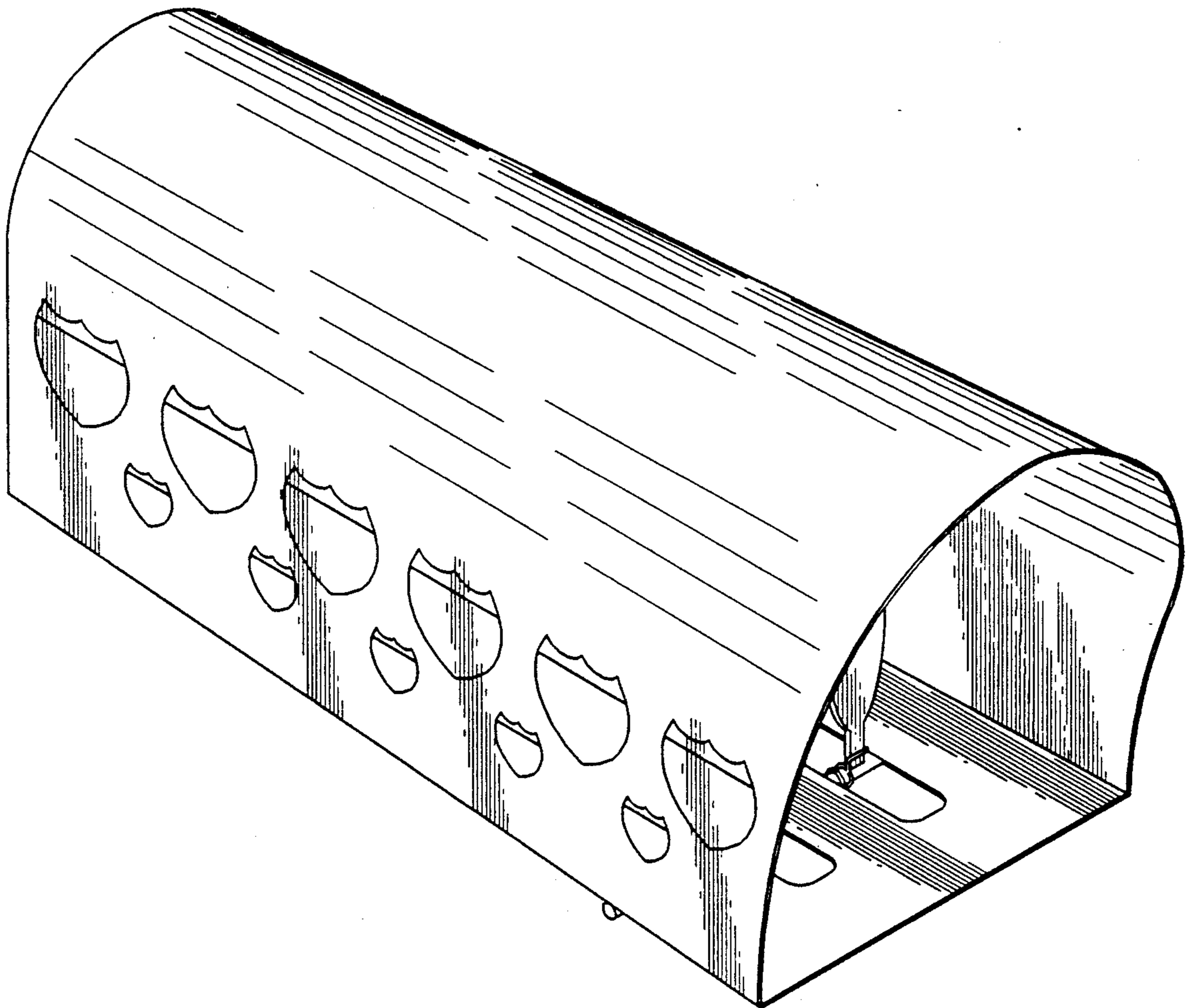

FIG. 1

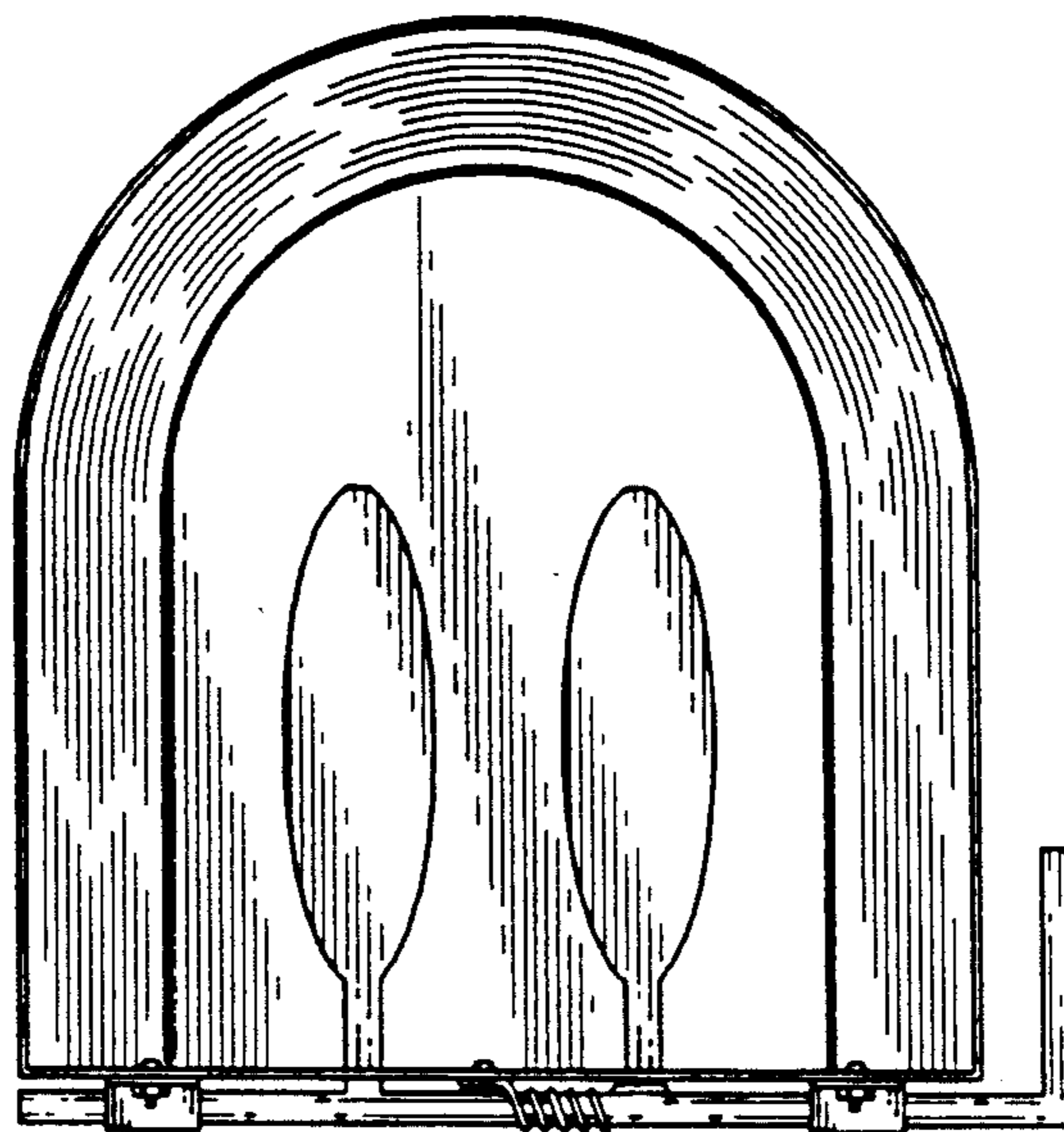

FIG. 2

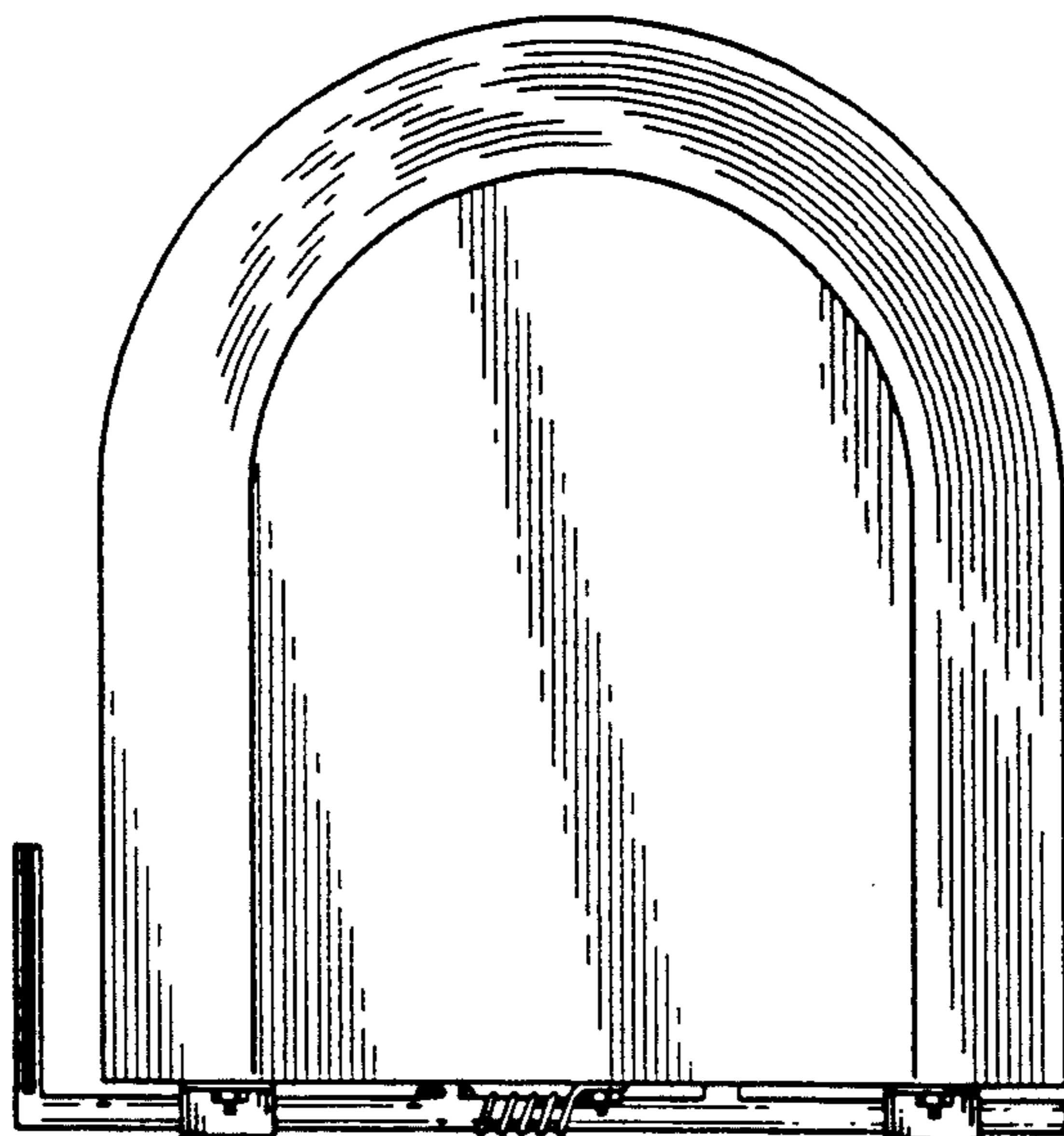

FIG. 3

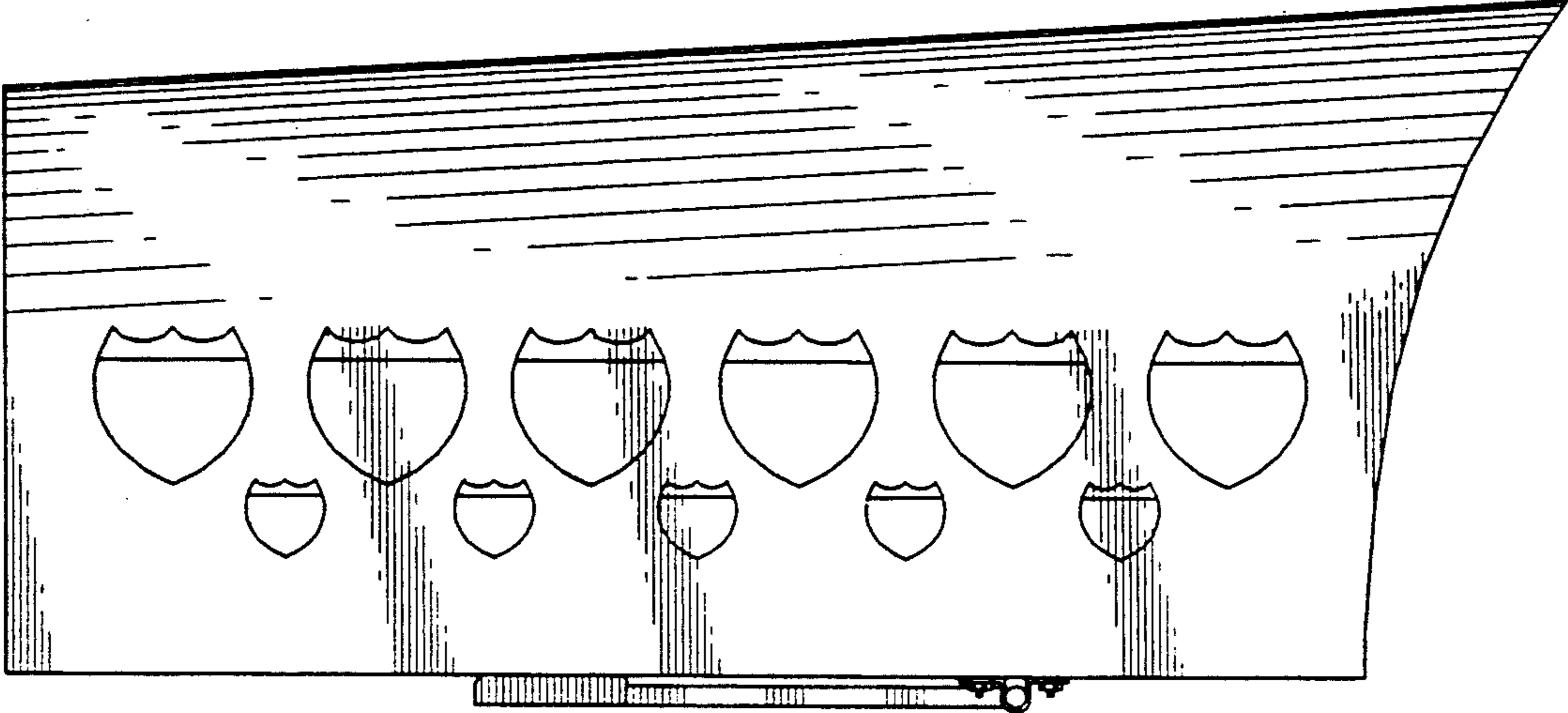

FIG. 4

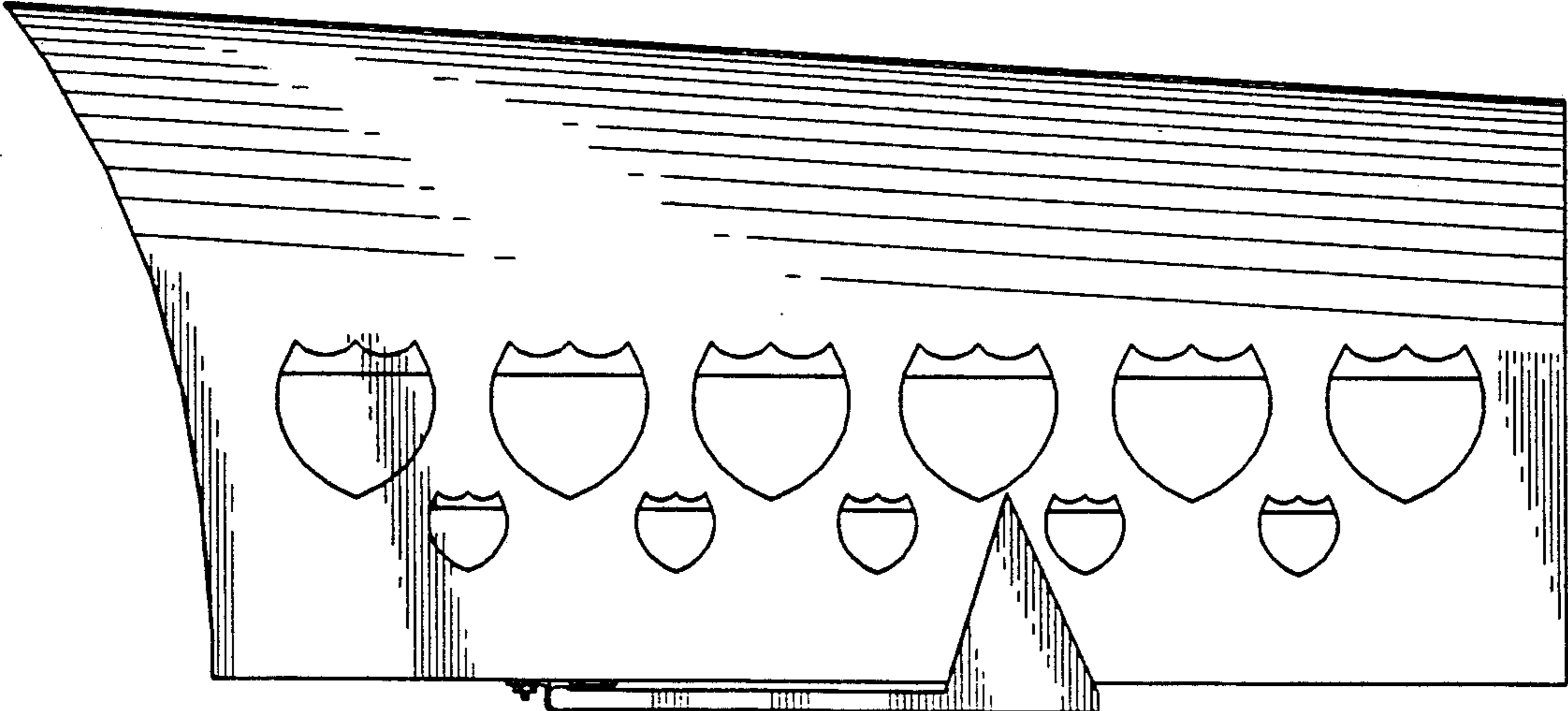

FIG. 5

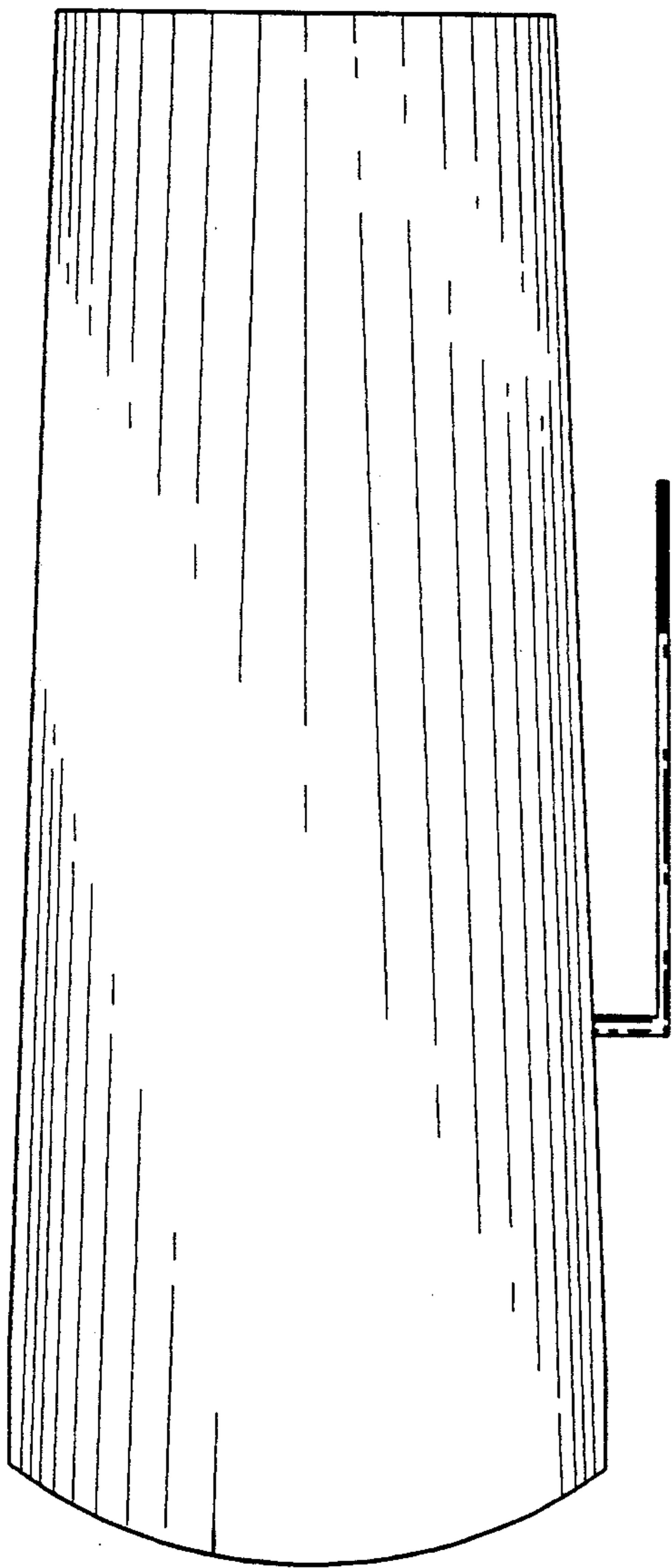

FIG. 6

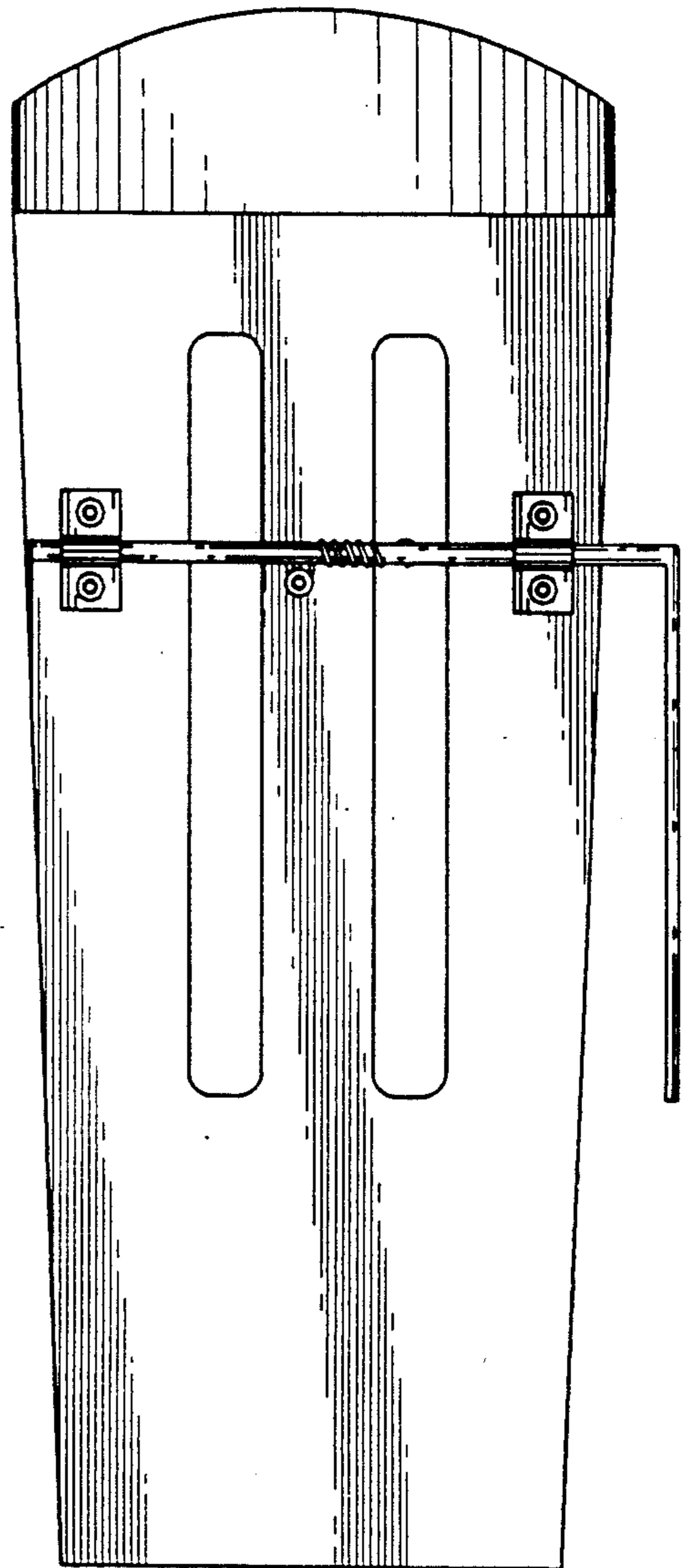

FIG. 7

