



US00D332087S

United States Patent [19]

[11] Patent Number: Des. 332,087

Woodard

[45] Date of Patent: ** Dec. 29, 1992

[54] LOCK OUT COVER PLATE

[76] Inventor: Ada May Woodard, Rte. 9, Box 487, Hendersonville, N.C. 28792

[**] Term: 14 Years

[21] Appl. No.: 584,853

[22] Filed: Sep. 19, 1990

[52] U.S. Cl. D13/177; D8/353

[58] Field of Search D8/353; D13/177; 174/67; 220/241; 70/174, 254, 255

[56] References Cited

U.S. PATENT DOCUMENTS

2,662,389	12/1953	McKitrick	70/174
3,096,409	7/1963	Hubbell et al.	D8/353
3,200,989	8/1965	Hubbell et al.	174/66
4,979,634	12/1990	Begley	174/67

OTHER PUBLICATIONS

Websters II—New Riverside Dictionary; ©1984; p. 1536; Pisces symbol.

“The Picture Book of Symbols”, E. Lehner; ©1956; p. 28; symbol for wealth.

Primary Examiner—B. J. Bullock
Attorney, Agent, or Firm—Leon Gilden

[57] CLAIM

The ornamental design for a lock out cover plate, as shown and described.

DESCRIPTION

FIG. 1 is a front elevational view of the lock out cover plate showing my new design;
FIG. 2 is a rear elevational view thereof;
FIG. 3 is a left side elevational view thereof;
FIG. 4 is a right side elevational view thereof;
FIG. 5 is an enlarged top plan view thereof;
FIG. 6 is an enlarged bottom plan view thereof; and,
FIG. 7 is a perspective view thereof in the open position.

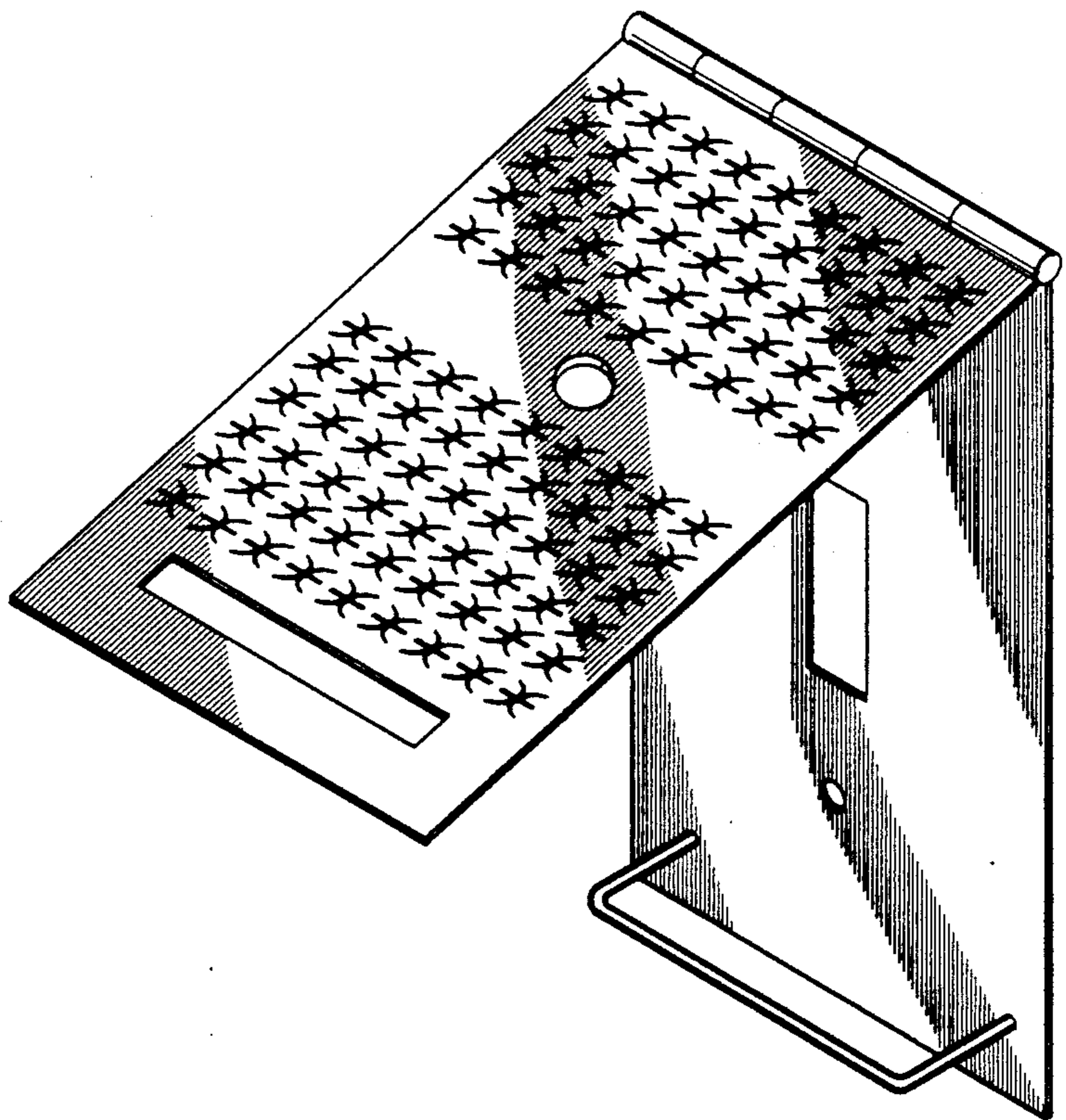
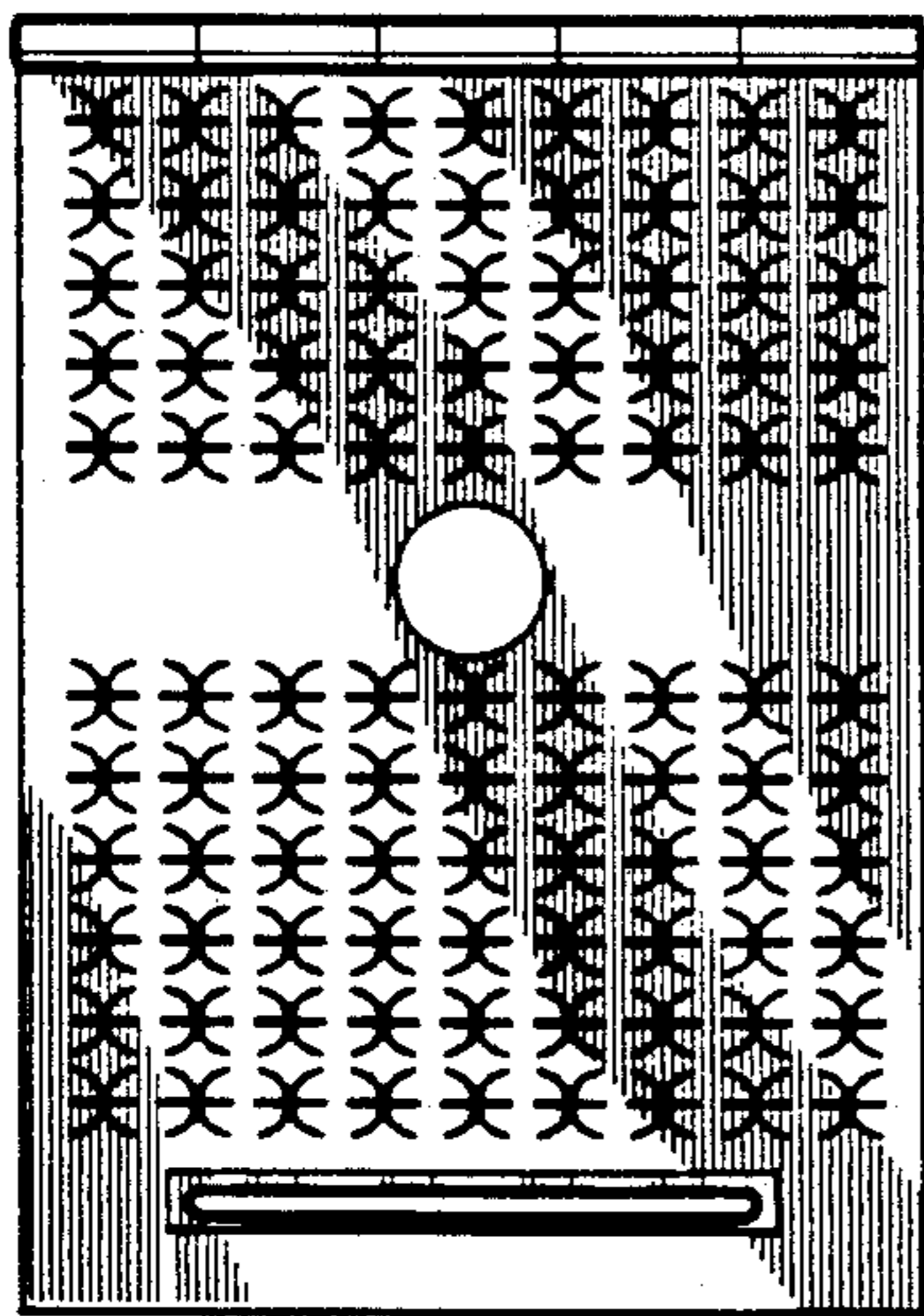

FIG. 1

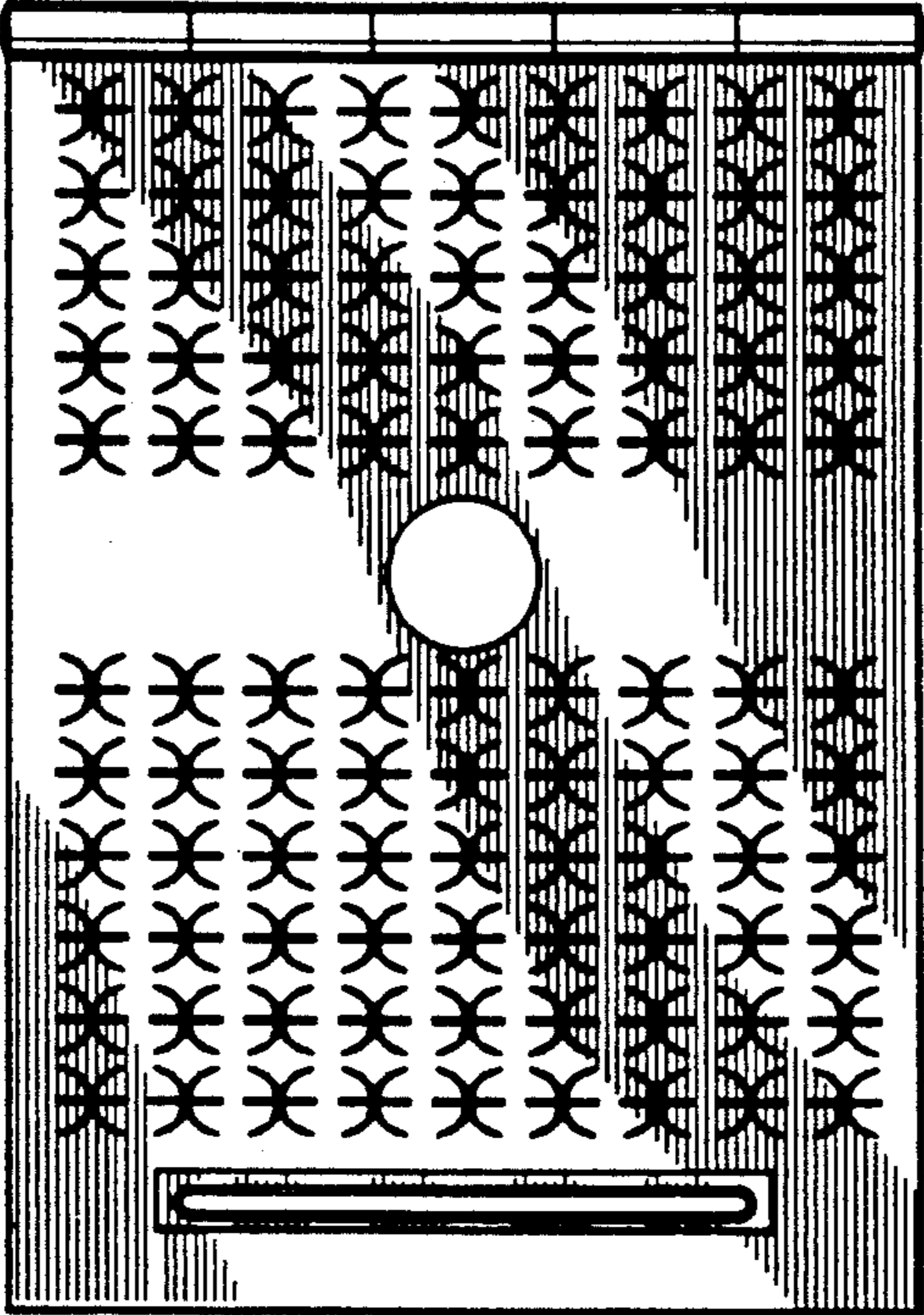

FIG. 2

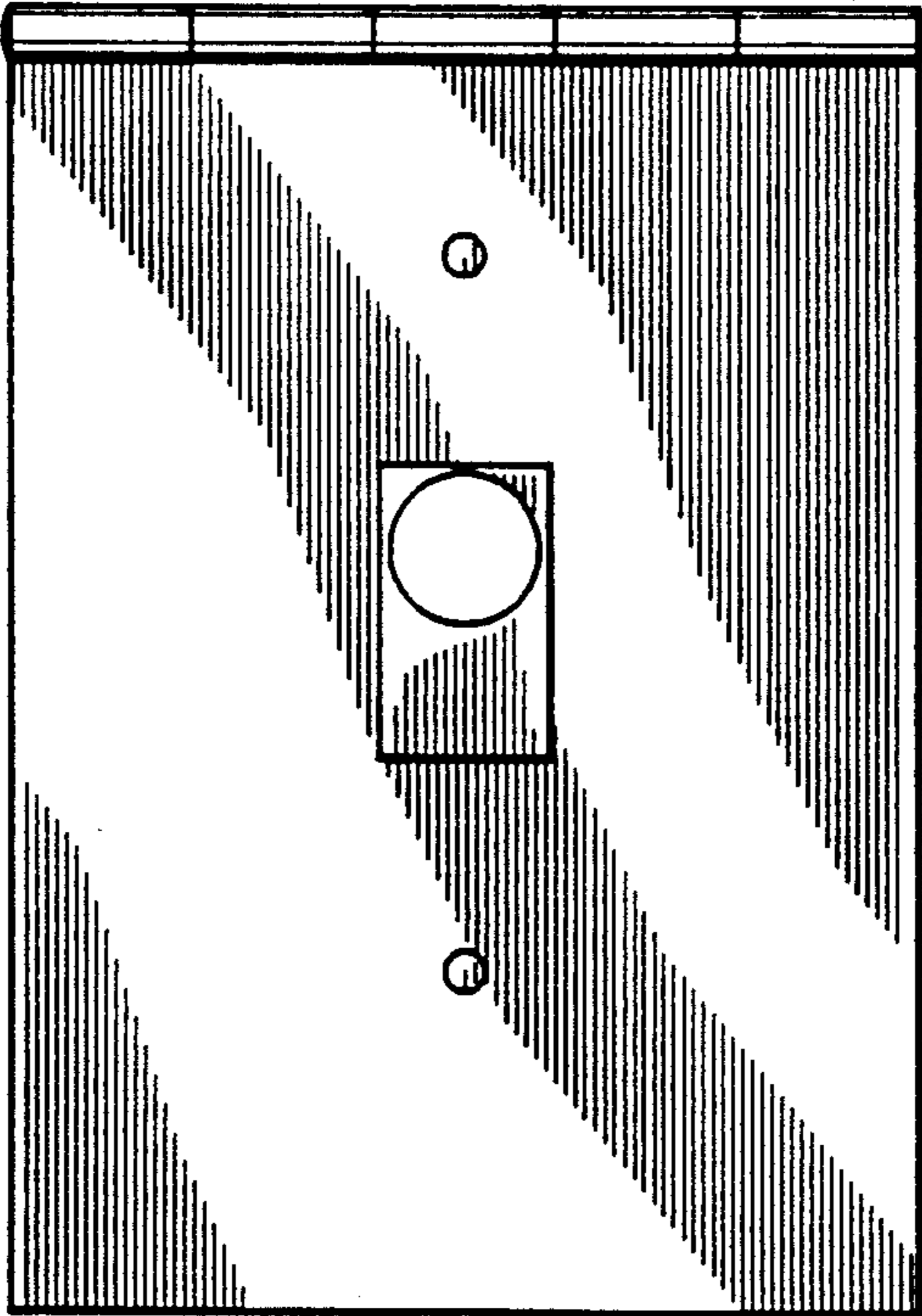

FIG. 3

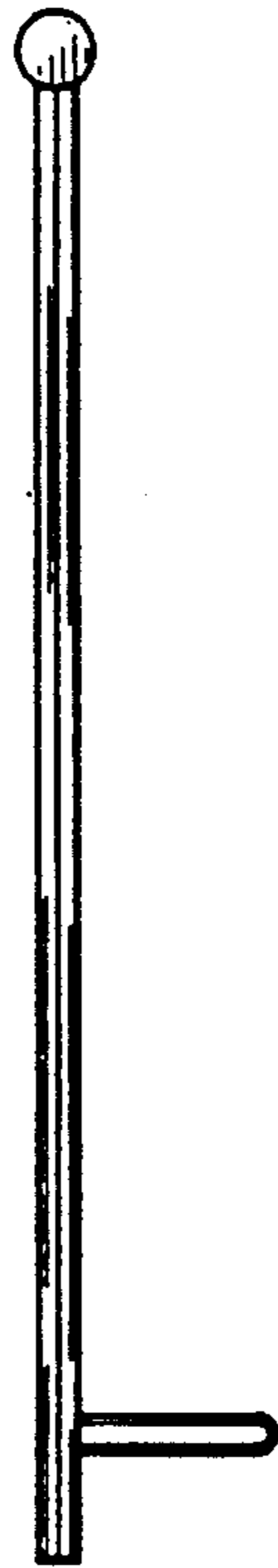

FIG. 4

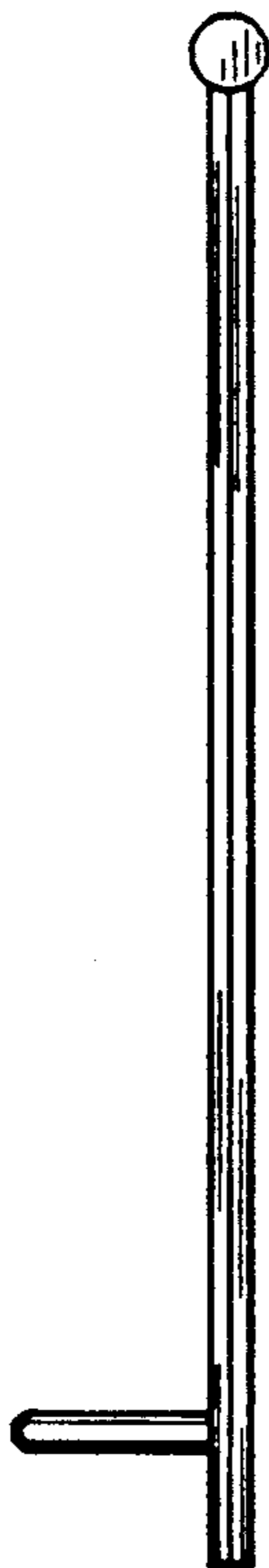

FIG. 5

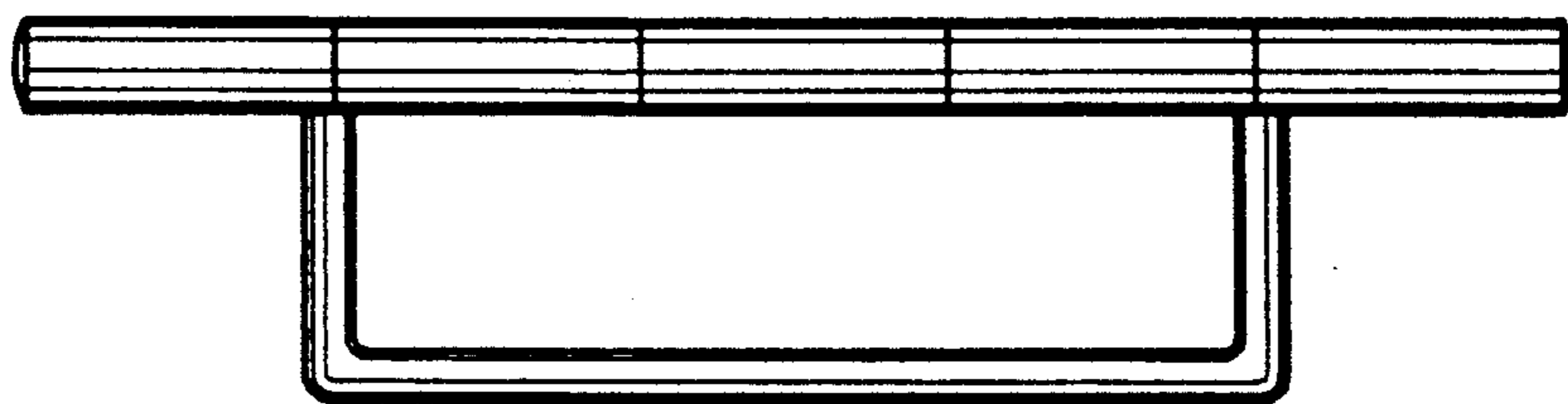

FIG. 6

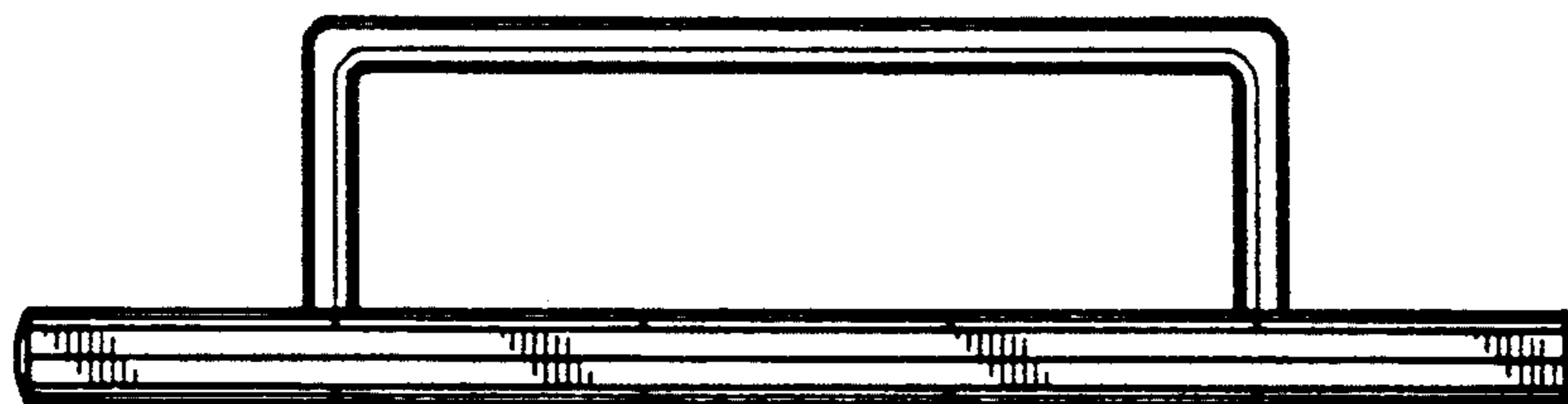

FIG 7

